

### 1. Dimensions:

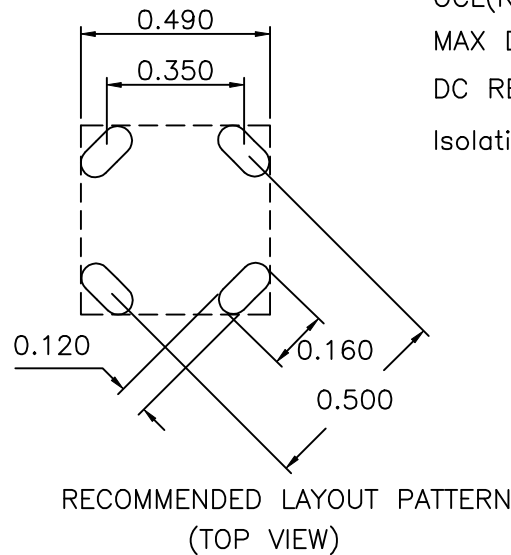

### 2. Schematic:

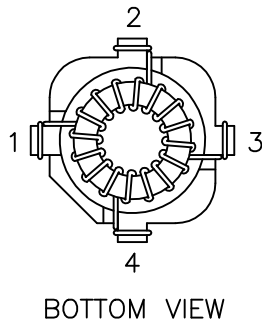
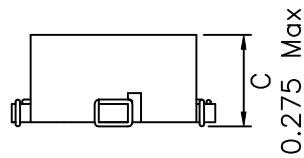
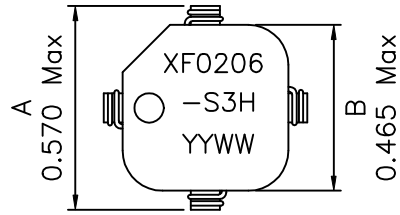
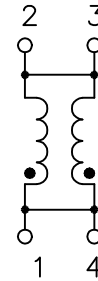

PARALLEL

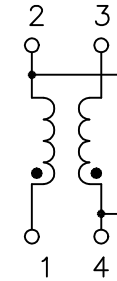

SERIES

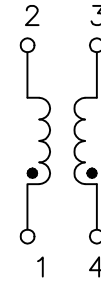

TRANSFORMER

### 3. Electrical Specifications: @25°C

	PARALLEL	SERIES	
OCL(NO DC):	19.58uH±20%	78.30uH±20%	10KHz,1.0V
MAX DC I:	3.00 ADC	1.50 ADC	
DC RES:	0.029 OHMS Typ	0.1154 OHMS Typ	
Isolation:	500 Vrms		

Note:

1. Solderability: Leads shall meet MIL-STD-202, Method 208D for solderability.
2. Flammability: UL94V-0,
3. ASTM oxygen index: > 28% ,
4. Temperature rating: 155°C. UL file E151556,
5. Operating Temperature Range: -40°C to +85°C

DOC. REV. A/1

<b>XFMRs Inc.</b>	Title: DUAL SURFACE MOUNT INDUCTOR		
	UNLESS OTHERWISE SPECIFIED	P/N: 7XF0206-S3H	REV. A
TOLERANCES: .xxx ±0.010	DWN.	廖玉坤	May-19-03
Dimensions in Inch	CHK.	李清儿	May-19-03
SCALE 2:1 SHT 1 OF 1	APP.	BW	May-19-03