

Typical Applications

The HMC800LP3E is ideal for:

- Test Equipment and Sensors
- ISM, MMDS, WLAN, WiMAX, WiBro
- Microwave Radio & VSAT
- Cellular Infrastructure

Features

- ± 0.3 dB Typical Step Error
- Low Insertion Loss: 2 dB
- High IP3: +55 dBm
- Single Control Line
- TTL/CMOS Compatible Control
- Single +5V Supply
- 16 Lead 3x3 mm SMT Package: 9 mm²

Functional Diagram

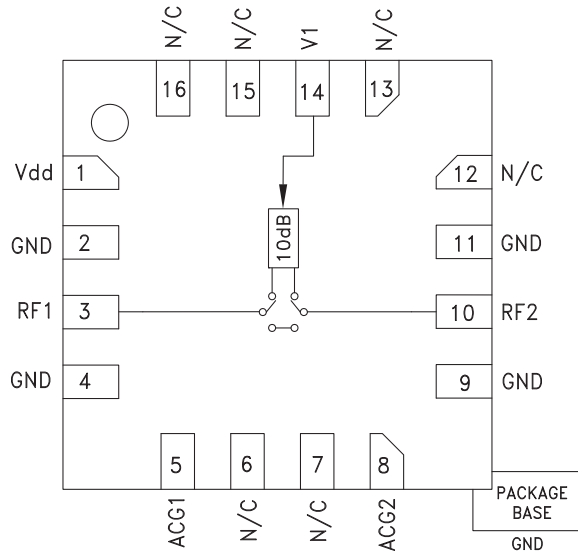

General Description

The HMC800LP3E is a broadband bidirectional 1-bit GaAs IC digital attenuator in a low cost leadless surface mount package. This single positive control line digital attenuator utilizes off chip AC ground capacitors for near DC operation, making it suitable for a wide variety of RF and IF applications. Covering DC to 10 GHz, the insertion loss is 2 dB typical and attenuation accuracy is excellent at ±0.3 dB typical step error. The attenuator also features a high Input IP3 of +55 dBm. One TTL/CMOS control input is used to select the attenuation state and a single Vdd bias of +5V is required.

Electrical Specifications, $T_A = +25^\circ C$, With $V_{dd} = +5V$ & $V_{ctl} = 0/+5V$

Parameter	Frequency	Min.	Typ.	Max.	Units
Insertion Loss	DC - 4 GHz		1.0	2.0	dB
	4 - 8 GHz		2.0	3.0	dB
	8 - 10 GHz		2.5	3.5	dB
Attenuation Range	DC - 10 GHz		10		dB
Return Loss (RF1 & RF2, Both States)	DC - 6 GHz		18		dB
	6 - 10 GHz		12		dB
Attenuation Accuracy: (Referenced to Insertion Loss)	DC - 6 GHz		± 0.2	± 0.4	dB
	6 - 10 GHz		± 0.3	± 0.6	dB
Input Power for 0.1 dB Compression	DC - 0.4 GHz		20		dBm
	0.4 - 10 GHz		30*		dBm
Input Third Order Intercept Point (Two-Tone Input Power= 0 dBm Each Tone)	DC - 0.4 GHz		45		dBm
	0.4 - 10 GHz		55		dBm
Switching Characteristics	DC - 10 GHz		120		ns
		tRISE, tFALL (10/90% RF)		150	ns
		tON, tOFF (50% CTL to 10/90% RF)			

* For frequencies greater than 0.4 GHz, the 0.1 dB compression point is greater than the absolute maximum RF input power of 30 dBm.



10 dB GaAs MMIC 1-BIT DIGITAL POSITIVE CONTROL ATTENUATOR, DC - 10 GHz

Insertion Loss

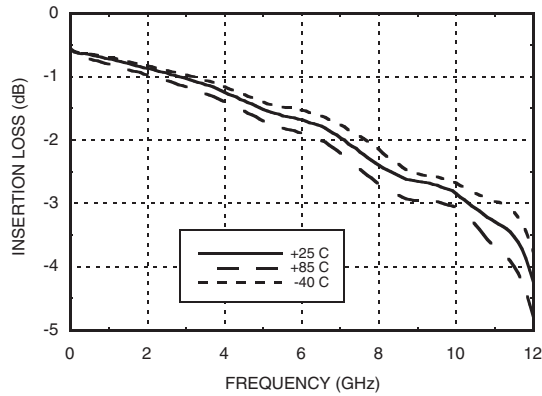

Input Return Loss

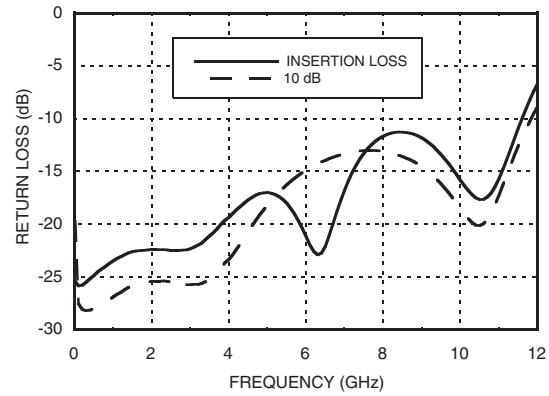

Output Return Loss

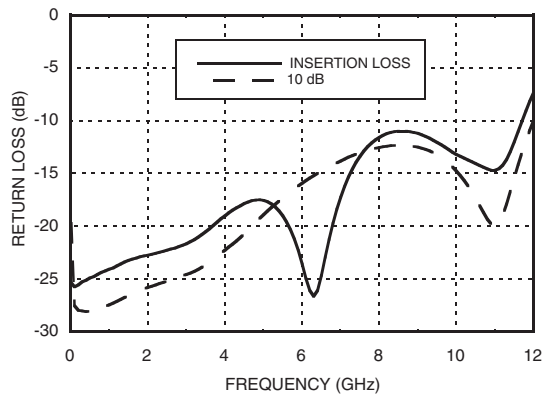

Relative Attenuation

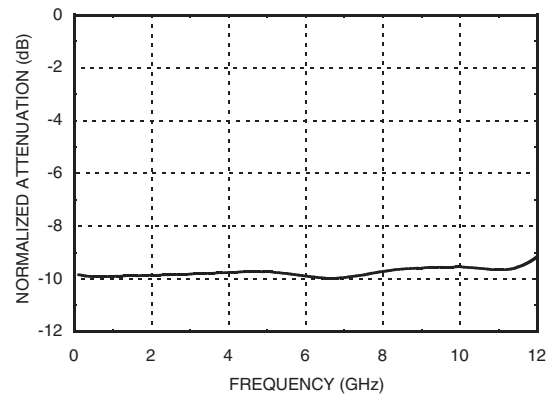

Relative Phase vs. Frequency

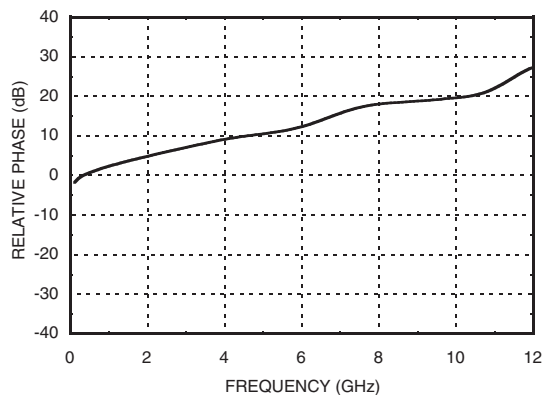

Bit Error vs. Frequency

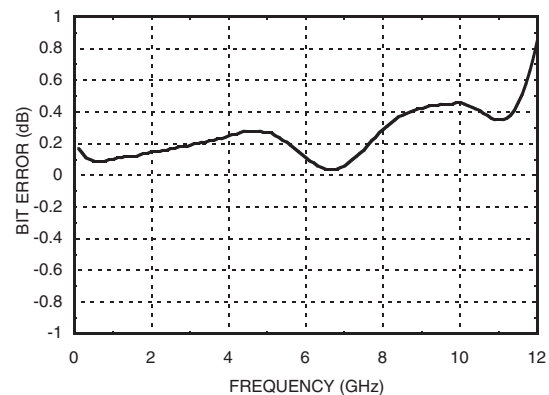



10 dB GaAs MMIC 1-BIT DIGITAL POSITIVE CONTROL ATTENUATOR, DC - 10 GHz

Input IP3 vs. Frequency

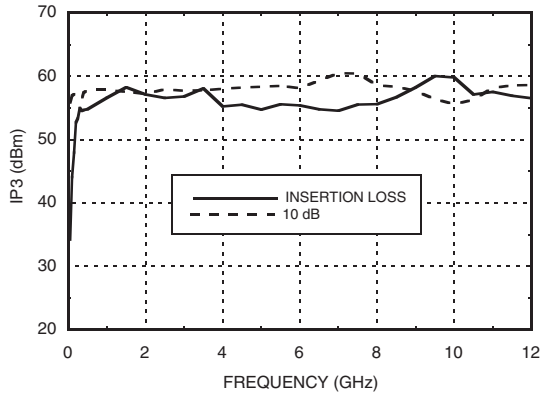

Input IP3 vs. Frequency (Low Frequency Detail)

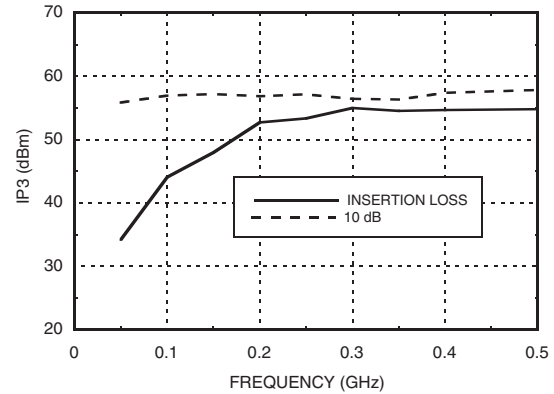

Input Power for 0.1 dB Compression* (Low Frequency Detail)

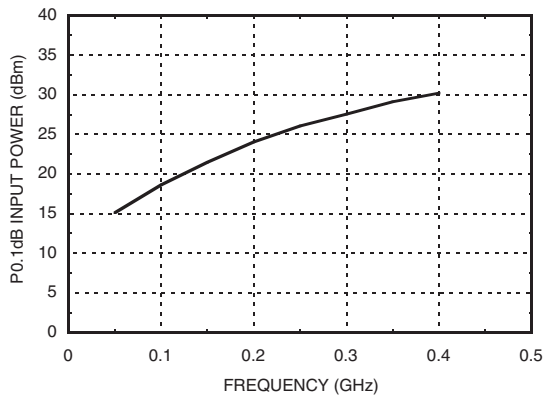

Truth Table

Control Voltage Input	Attenuation State
V1	RF1 - RF2
High	Reference Insertion Loss
Low	10 dB

Bias Voltage & Current

Vdd = +5 Vdc ± 10%	
Vdd (Vdc)	Idd (Typ.) (mA)
4.5	0.21
5.0	0.23
5.5	0.25

Control Voltage

State	Bias Condition
Low	0 to +0.8V @ -1 μA Typ.
High	+2 to +5V @ 30 μA Typ.

Note: Vdd = +5V

* For frequencies greater than 0.4 GHz, the 0.1 dB compression point is greater than the absolute maximum RF input power of 30 dBm.

Absolute Maximum Ratings

RF Input Power (DC - 10 GHz)	+30 dBm
Control Voltage Range (V1)	-1 to Vdd +1 V
Bias Voltage (Vdd)	+7 Vdc
Channel Temperature	150 °C
Continuous P _{diss} (T = 85 °C) (derate 12 mW/°C above 85 °C)	0.783 W
Thermal Resistance (Channel to ground paddle)	83 °C/W
Storage Temperature	-65 to +150 °C
Operating Temperature	-40 to +85 °C
ESD Sensitivity (HBM)	Class 1A



ELECTROSTATIC SENSITIVE DEVICE
OBSERVE HANDLING PRECAUTIONS

Outline Drawing

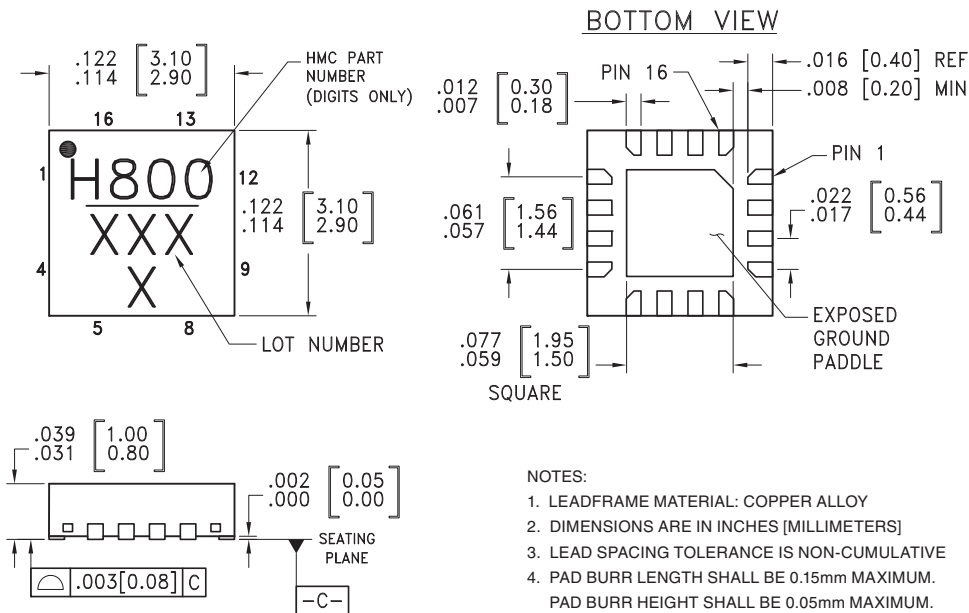

Package Information

Part Number	Package Body Material	Lead Finish	MSL Rating	Package Marking ^[2]
HMC800LP3E	RoHS-compliant Low Stress Injection Molded Plastic	100% matte Sn	MSL1 ^[1]	H800 XXXX

[1] Max peak reflow temperature of 260 °C

[2] 4-Digit lot number XXXX



10 dB GaAs MMIC 1-BIT DIGITAL POSITIVE CONTROL ATTENUATOR, DC - 10 GHz

Pin Descriptions

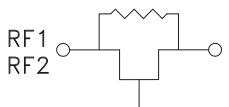
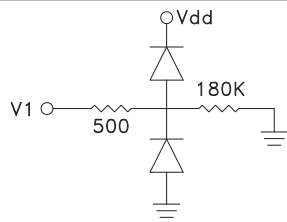
Pin Number	Function	Description	Interface Schematic
1	Vdd	Supply Voltage.	
2, 4, 9, 11	GND	These pins and the exposed ground paddle must be connected to RF/DC ground.	
3, 10	RF1, RF2	These pins are DC coupled and matched to 50 Ohms. Blocking capacitors are required. Select value based on lowest frequency of operation.	
5, 8	ACG1, ACG2	External capacitor to ground is required. Select value for lowest frequency of operation. Place capacitor as close to pins as possible.	
6, 7, 12, 13, 15, 16	N/C	The pins are not connected internally; however, all data shown herein was measured with these pins connected to RF/DC ground externally.	
14	V1	See truth table and control voltage table.	

Application Circuit

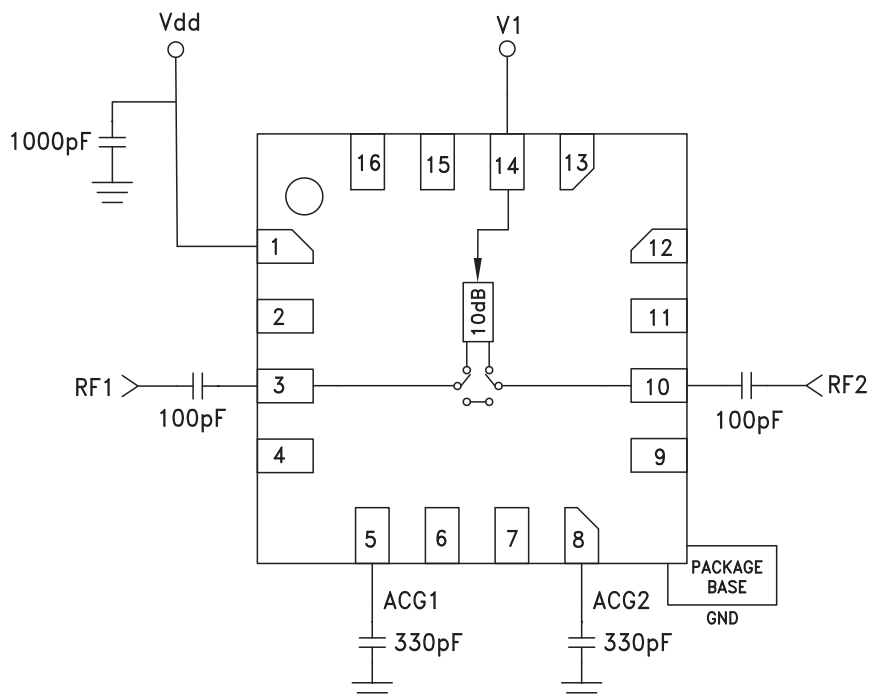

Evaluation PCB

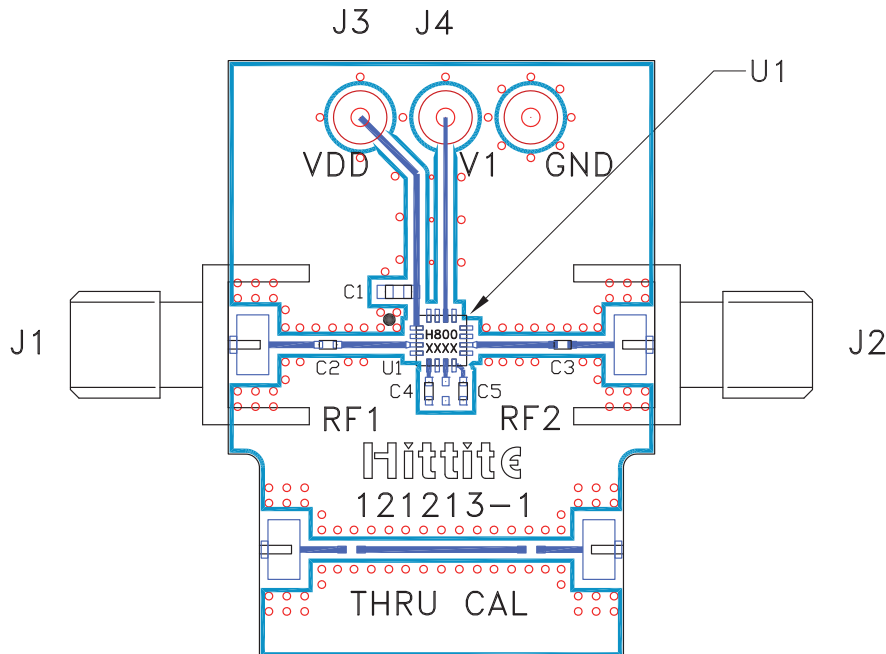

List of Materials for Evaluation PCB 126894 [1]

Item	Description
J1, J2	PCB Mount SMA Connector
J3, J4	DC Connector
C1	1000 pF Capacitor, 0603 Pkg.
C2, C3	100 pF Capacitor, 0402 Pkg.
C4, C5	330 pF Capacitor, 0402 Pkg.
U1	HMC800LP3E Digital Attenuator
PCB [2]	121213 Evaluation PCB

[1] Reference this number when ordering complete evaluation PCB

[2] Circuit Board Material: Rogers 4350 or Arlon 25 FR

The circuit board used in the application should use RF circuit design techniques. Signal lines should have 50 Ohm impedance while the package ground leads and exposed paddle should be connected directly to the ground plane similar to that shown. A sufficient number of via holes should be used to connect the top and bottom ground planes. The evaluation circuit board shown is available from Hittite upon request.