

4-Line BUS-port ESD-protection

Features

- Ultra compact LLP1010-5L package
- Low package height < 0.4 mm
- 4-line USB ESD-protection
- Low leakage current
- Low load capacitance $C_D = 0.8$ pF
- ESD-protection to IEC 61000-4-2
± 15 kV contact discharge
± 15 kV air discharge
- Pin plating NiPdAu (e4) no whisker growth
- Compliant to RoHS directive 2002/95/EC and in accordance to WEEE 2002/96/EC



RoHS
COMPLIANT
GREEN
(5-2008)**

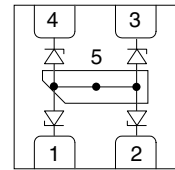
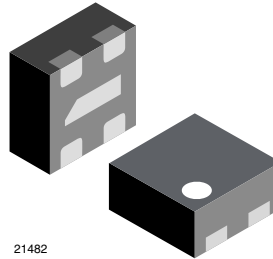

21482

21483

Marking (example only)

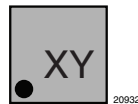

Dot = Pin 1 marking
X = Date code
Y = Type code (see table below)

Ordering Information

Device name	Ordering code	Taped units per reel (8 mm tape on 7" reel)	Minimum order quantity
VBUS054DD-HF4	VBUS054DD-HF4-GS08	5000	5000

Package Data

Device name	Package name	Marking code	Weight	Molding compound flammability rating	Moisture sensitivity level	Soldering conditions
VBUS054DD-HF4	LLP1010-5L	C	1.07 mg	UL 94 V-0	MSL level 1 (according J-STD-020)	260 °C/10 s at terminals

Absolute Maximum Ratings

Rating	Test conditions	Symbol	Value	Unit
Peak pulse current	Pin 1, 2, 3 or 4 to pin 5 acc. IEC 61000-4-5; $t_p = 8/20$ μ s; single shot	I_{PPM}	3	A
Peak pulse power	Pin 1, 2, 3 or 4 to pin 5 acc. IEC 61000-4-5; $t_p = 8/20$ μ s; single shot	P_{PP}	45	W
ESD immunity	Contact discharge acc. IEC 61000-4-2; 10 pulses	V_{ESD}	± 15	kV
	Air discharge acc. IEC 61000-4-2; 10 pulses	V_{ESD}	± 15	kV
Operating temperature	Junction temperature	T_J	- 40 to + 125	°C
Storage temperature		T_{STG}	- 55 to + 150	°C

** Please see document "Vishay Material Category Policy": www.vishay.com/doc?99902

Electrical Characteristics

Ratings at 25 °C, ambient temperature unless otherwise specified

VBUS054DD-HF4

Pin 1, 2, 3 or 4 to pin 5

Parameter	Test conditions/remarks	Symbol	Min.	Typ.	Max.	Unit
Protection paths	Number of line which can be protected	N lines			4	lines
Reverse stand-off voltage	at $I_R = 0.1 \mu\text{A}$	V_{RWM}	5			V
Reverse current	at $V_{IN} = V_{RWM} = 5 \text{ V}$	I_R		< 0.01	0.1	μA
Reverse breakdown voltage	at $I_R = 1 \text{ mA}$	V_{BR}	6.9	8	8.7	V
Reverse clamping voltage	at $I_{PP} = 3 \text{ A}$; acc. IEC 61000-4-5	V_C		16	19	V
Forward clamping voltage	at $I_F = 3 \text{ A}$; acc. IEC 61000-4-5	V_F		3.5	4.5	V
Capacitance	$V_{IN} = 0 \text{ V}$	C_D		0.8	1	pF
	$V_{IN} = 2.5 \text{ V}$	C_D		0.5	0.8	pF
Line symmetry	Difference of the line capacitances	dC_D			0.05	pF

Typical Characteristics ($T_{amb} = 25 \text{ }^\circ\text{C}$, unless otherwise specified)

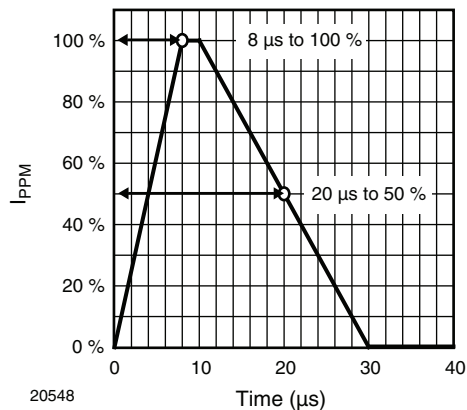

Figure 1. 8/20 μs Peak Pulse Current Wave Form acc. IEC 61000-4-5

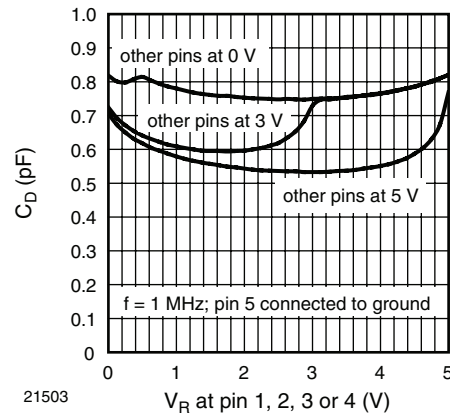

Figure 3. Typical Capacitance C_D vs. Reverse Voltage V_R

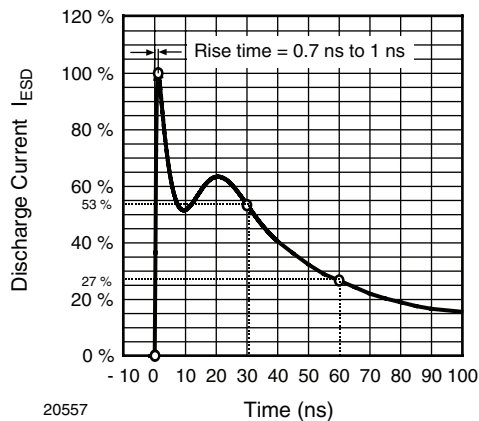

Figure 2. ESD Discharge Current Wave Form acc. IEC 61000-4-2 (330 Ω /150 pF)

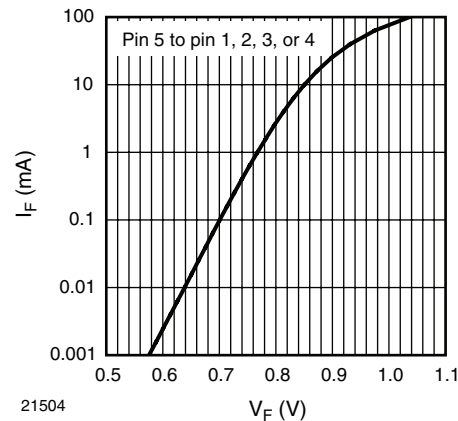

Figure 4. Typical Forward Current I_F vs. Forward Voltage V_F

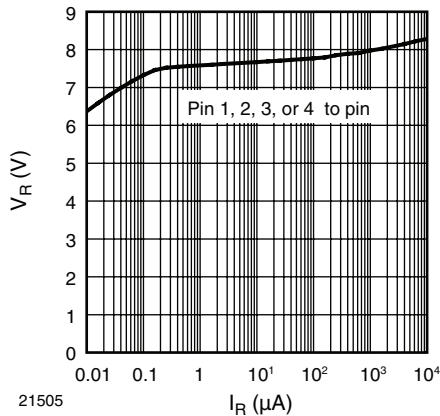

Figure 5. Typical Reverse Voltage V_R vs. Reverse Current I_R

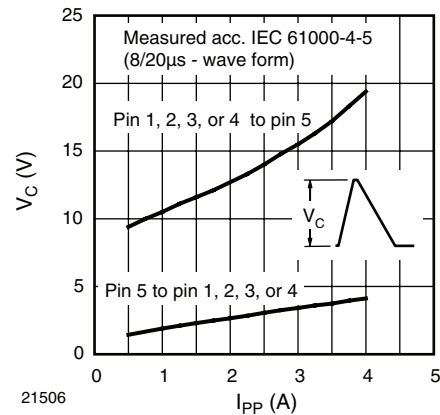
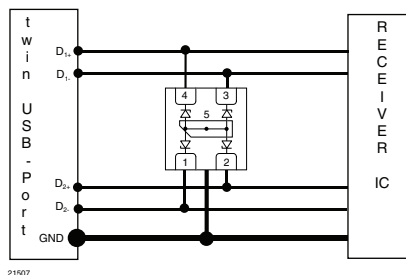

Figure 6. Typical Peak Clamping Voltage V_C vs. Peak Pulse Current I_{PP}

Application Note:

With the **VBUS054DD-HF4** a double, high speed USB-port or up to 4 other high speed signal or data lines can be protected against transient voltage signals. Negative transients will be clamped close below the ground level while positive transients will be clamped close above the 5 V working range. The high speed data lines, D_{1+} , D_{2+} , D_{1-} and D_{2-} , are connected to pin 1, 2, 3, and 4, pin 5 is connected to ground. As long as the signal voltage on the data lines is between the ground- and the breakthrough-level, the low input capacitance of each channel offer a very high isolation to ground and to the other data lines. But as soon as any transient signal exceeds this working range, the **VBUS054DD-HF4** clamps the transient to ground or to the avalanche breakthrough voltage level.



Background knowledge:

A zener- or avalanche diode is an ideal device for “cutting” or “clamping” voltage spikes or voltage transients down to low and uncritical voltage values. The breakthrough voltage can easily be adjusted by the chip-technology to any desired value within a wide range. Up to about 6 V the “zener-effect” (tunnel-effect) is responsible for the breakthrough characteristic. Above 6 V the so-called “avalanche-effect” is responsible. This is a more abrupt breakthrough phenomenon. Because of the typical “Z-shape” of the current-voltage-curve of such diodes, these diodes are generally called “Z-diode” (= zener or avalanche diodes). An equally important parameter for a protection diode is the ESD- and surge-power that allows the diode to short current in the pulse to ground without being destroyed.

This requirement can be adjusted by the size of the silicon chip (crystal). The bigger the active area the higher the current that the diode can short to ground.

But the active area is also responsible for the diode capacitance - the bigger the area the higher the capacitance.

The dilemma is that a lot of applications require an effective protection against more than 8 kV ESD while the capacitance must be lower than 5 pF! This is well out of the normal range of a Z-diode. However, a protection diode with a low capacitance PN-diode (switching diode or junction diode) in series with a Z-diode, can fulfil

both requirements simultaneously: low capacitance AND high ESD- and/or surge immunity become possible! A small signal ($V_{pp} < 100 \text{ mV}$) just sees the low capacitance of the PN-diode, while the big capacitance of the Z-diode in series remains "invisible".

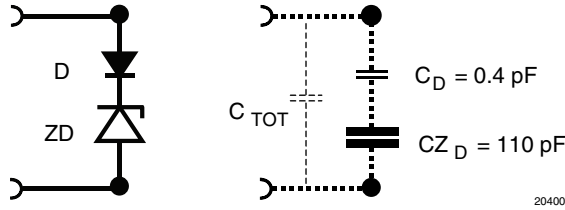

Such a constellation with a Z-diode and a small PN-diode (with low capacitance) in series (anti-serial) is a real unidirectional protection device. The clamping current can only flow in one direction (forward) in the PN-diode. The reverse path is blocked.

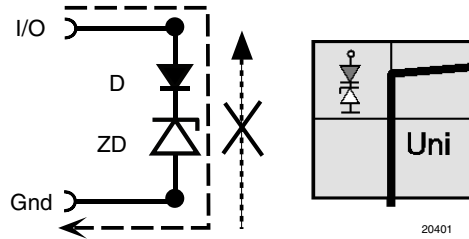

Another PN-diode "opens" the back path so that the protection device becomes bidirectional! Because the clamping voltage levels in forward and reverse directions are different, such a protection device has a **Bidirectional** and **Asymmetrical** clamping behaviour (**BiAs**) just like a single Z-diode.

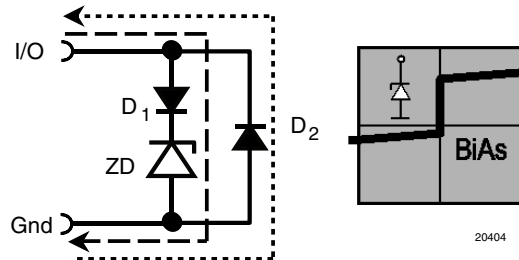

The VBUS054DD-HF4 offers four inputs with such protection circuit inside.

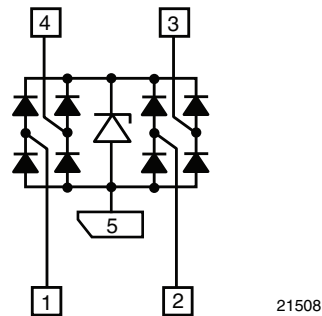

Package Dimensions in millimeters (inches): LLP1010-5L

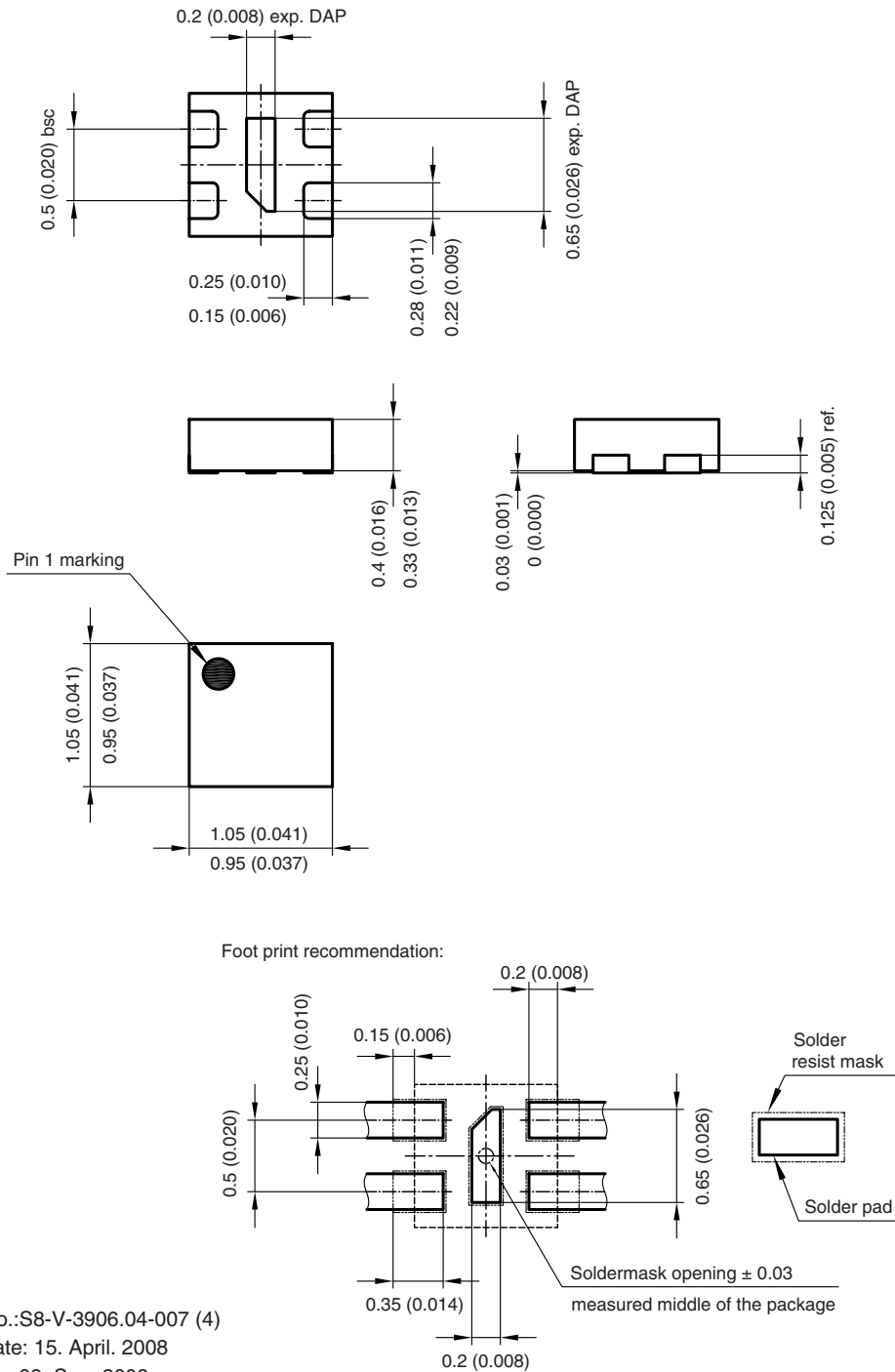

Document no.:S8-V-3906.04-007 (4)

Created - Date: 15. April. 2008

Rev. 2 - Date: 09. Sep. 2008

21380



Disclaimer

ALL PRODUCT, PRODUCT SPECIFICATIONS AND DATA ARE SUBJECT TO CHANGE WITHOUT NOTICE TO IMPROVE RELIABILITY, FUNCTION OR DESIGN OR OTHERWISE.

Vishay Intertechnology, Inc., its affiliates, agents, and employees, and all persons acting on its or their behalf (collectively, "Vishay"), disclaim any and all liability for any errors, inaccuracies or incompleteness contained in any datasheet or in any other disclosure relating to any product.

Vishay makes no warranty, representation or guarantee regarding the suitability of the products for any particular purpose or the continuing production of any product. To the maximum extent permitted by applicable law, Vishay disclaims (i) any and all liability arising out of the application or use of any product, (ii) any and all liability, including without limitation special, consequential or incidental damages, and (iii) any and all implied warranties, including warranties of fitness for particular purpose, non-infringement and merchantability.

Statements regarding the suitability of products for certain types of applications are based on Vishay's knowledge of typical requirements that are often placed on Vishay products in generic applications. Such statements are not binding statements about the suitability of products for a particular application. It is the customer's responsibility to validate that a particular product with the properties described in the product specification is suitable for use in a particular application. Parameters provided in datasheets and/or specifications may vary in different applications and performance may vary over time. All operating parameters, including typical parameters, must be validated for each customer application by the customer's technical experts. Product specifications do not expand or otherwise modify Vishay's terms and conditions of purchase, including but not limited to the warranty expressed therein.

Except as expressly indicated in writing, Vishay products are not designed for use in medical, life-saving, or life-sustaining applications or for any other application in which the failure of the Vishay product could result in personal injury or death. Customers using or selling Vishay products not expressly indicated for use in such applications do so at their own risk and agree to fully indemnify and hold Vishay and its distributors harmless from and against any and all claims, liabilities, expenses and damages arising or resulting in connection with such use or sale, including attorneys fees, even if such claim alleges that Vishay or its distributor was negligent regarding the design or manufacture of the part. Please contact authorized Vishay personnel to obtain written terms and conditions regarding products designed for such applications.

No license, express or implied, by estoppel or otherwise, to any intellectual property rights is granted by this document or by any conduct of Vishay. Product names and markings noted herein may be trademarks of their respective owners.