

MTD8000N

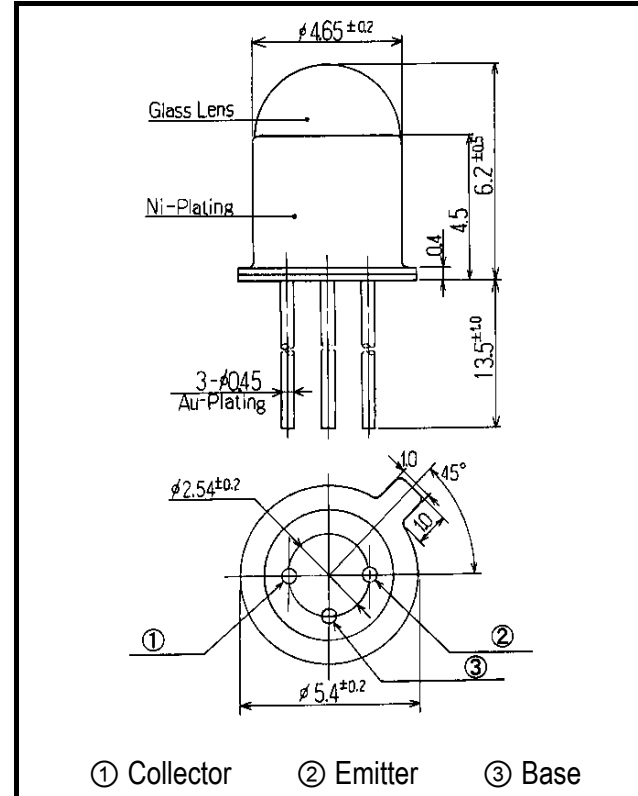
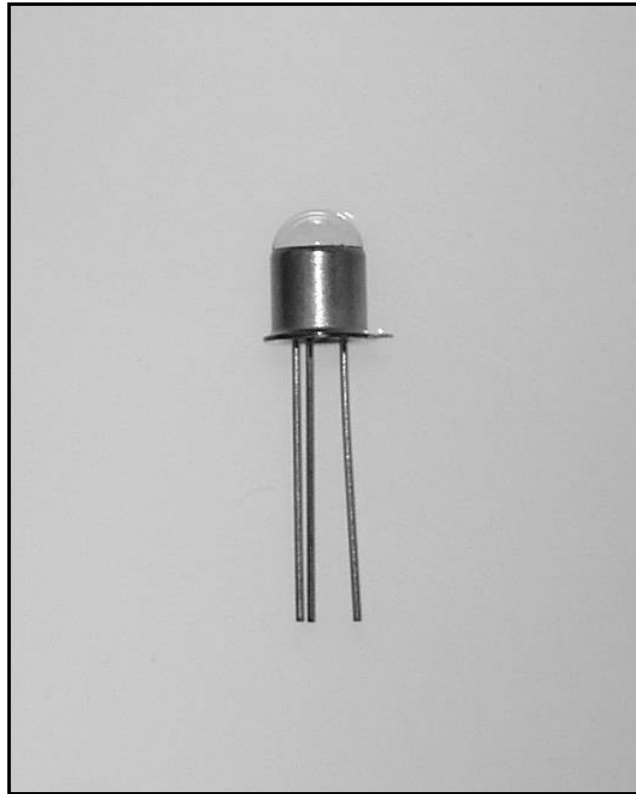

- FEATURES**
- High Reliability in Demanding Environments (Mental Can Package)
 - Narrow Angular Response
 - Compact
- APPLICATIONS**
- Optical Switches
 - Edge Sensing
 - Fiber Optical Communications
 - Smoke Detectors

1. ABSOLUTE MAXIMUM RATINGS

ITEM	SYMBOL	RATINGS	UNIT
Collector-Emitter Voltage	V _{ceo}	30	V
Emitter-Collector Voltage	V _{eco}	5	V
Collector Current	I _c	50	mA
Collector Power Dissipation	P _c	150	mW
Operating Temp.	T _{opr}	-30 TO 100	°C
Storage Temp.	T _{stg}	-40 TO 125	°C
Junction Temp.	T _j	125	°C
Lead Soldering Temp.*	T _{ls}	260	°C

*Time 5 Sec max, Position: Up to 3mm from the body

2. ELECTRICAL & OPTICAL CHARACTERISTICS (T_a=25°C)

ITEM	SYMBOL	CONDITIONS	MIN	TYP	MAX	UNIT
Light Current	I _L	V _{ce} =20V, L=100Lux※		3.0		mA
Dark Current	I _D	V _{ce} =20V			100	nA
C-E Saturation Voltage	V _{CE(sat)}	I _c =0.2mA, L=1000Lux※		0.2		V
Spectral sensitivity	λ			400 ~ 1100		nm
(With Daylight Filter)	λ	※ ※		800 ~ 1100		nm
Peak Sensitivity Wave Length	λ _p			880		nm
Switching time (Rise Time)	T _r	R=100Ω, V _{cc} =5V, I _c =1mA		10.0		μS
Switching time (Fall Time)	T _f	R=100Ω, V _{cc} =5V, I _c =1mA		10.0		μS
Half Intensity Beam Angle	θ			±12		deg
Package Drawing No.				N4		

※ Color Temperature=2870°K Standard Tungsten Lump

※ ※ With Daylight Filter Type (Sensing Only IR Rays) also Available

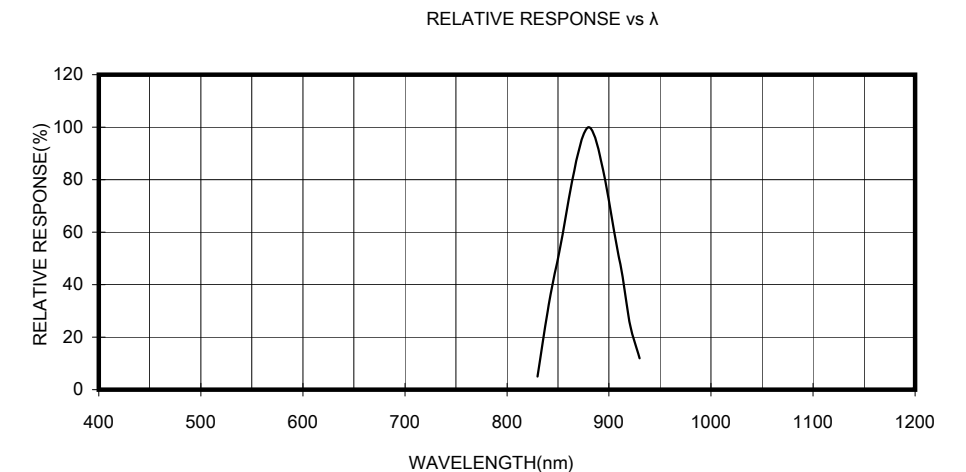
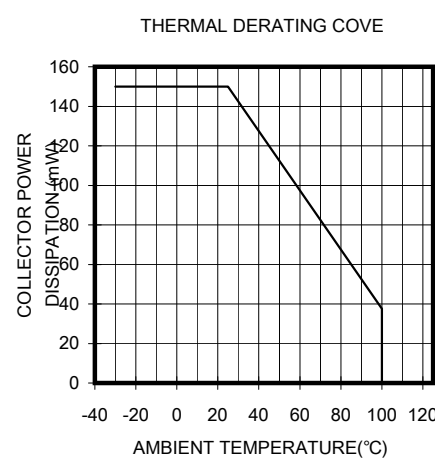
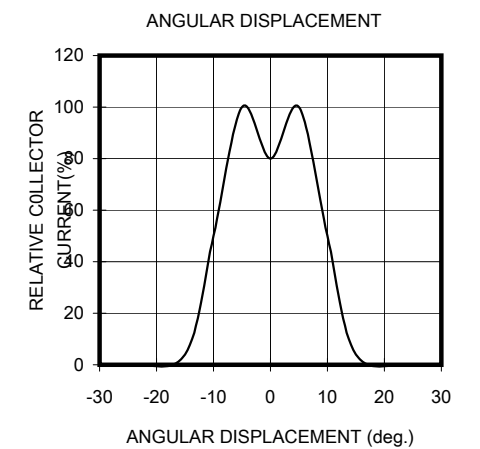
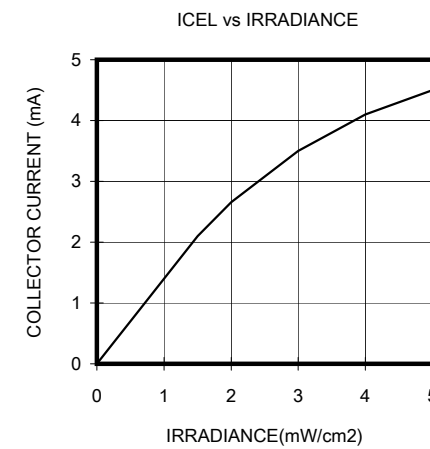
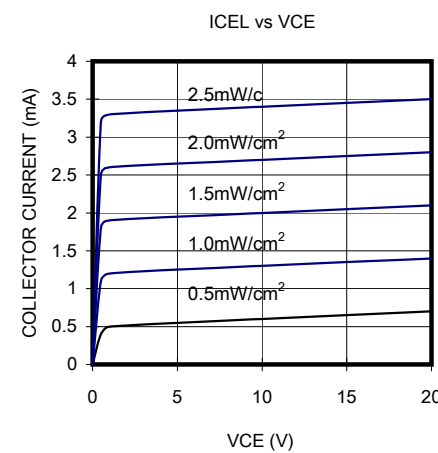

To purchase this part contact
Marktech Optoelectronics at
800.984.5337

Marktech
Optoelectronics
www.marktechopto.com

