



## U74AHCT1G02

CMOS IC

### 2-INPUT NOR GATE

#### DESCRIPTION

The **U74AHCT1G02** is a single 2-input NOR gate which provides the Function.

#### FEATURES

- \* Operation Voltage Range: 2.0~5.5V
- \* Low Power Dissipation
- \* High noise immunity
- \*Balanced propagation delays
- \*Specified from -40 to +125°C

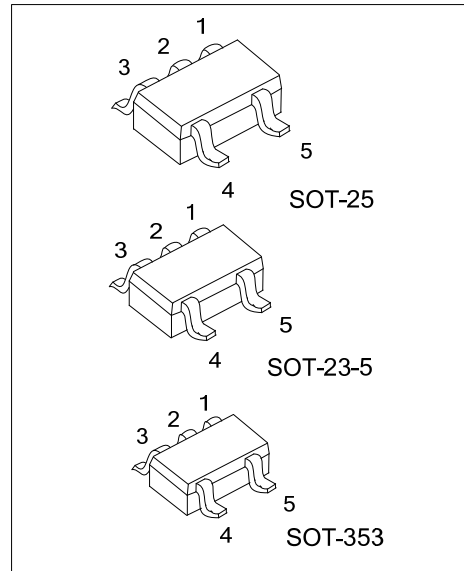

#### ORDERING INFORMATION

Ordering Number		Package	Packing
Lead Free	Halogen Free		
U74AHCT1G02L-AE5-R	U74AHCT1G02G-AE5-R	SOT-23-5	Tape Reel
U74AHCT1G02L-AF5-R	U74AHCT1G02G-AF5-R	SOT-25	Tape Reel
U74AHCT1G02L-AL5-R	U74AHCT1G02G-AL5-R	SOT-353	Tape Reel

<p>U74AHCT1G02L-AF5-R</p> <p>(1)Packing Type (2)Package Type (3)Lead Free</p>	<p>(1) R: Tape Reel (2) AE5: SOT-23-5, AF5: SOT-25, AL5: SOT-353 (3) G: Halogen Free, L: Lead Free</p>
---	--

#### MARKING

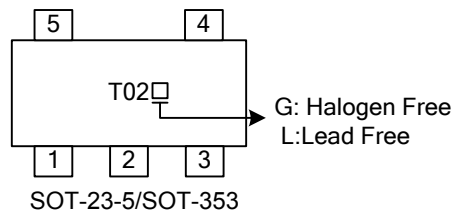
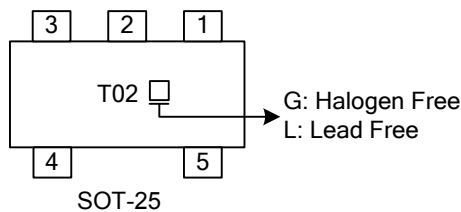

■ PIN CONFIGURATION

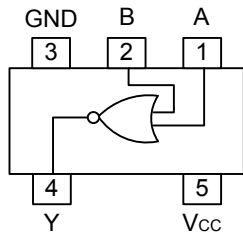

■ FUNCTION TABLE

INPUT		OUTPUT
A	B	Y
L	L	H
L	H	L
H	L	L
H	H	L

■ LOGIC DIAGRAM (positive logic)

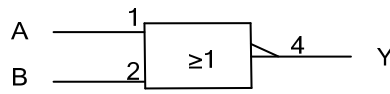
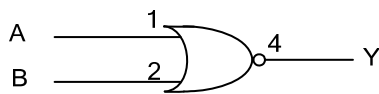

IEC logic symbol

■ ABSOLUTE MAXIMUM RATINGS (unless otherwise specified)

PARAMETER	SYMBOL	RATINGS	UNIT
Supply Voltage	$V_{CC}$	-0.5~7	V
Input Voltage	$V_{IN}$	-0.5~7	V
Output Voltage	$V_{OUT}$	-0.5~ $V_{CC}+0.5$	V
Input Clamp Current	$I_{IK}$	±20	mA
Output Clamp Current	$I_{OK}$	±20	mA
Continuous Output Current	$I_{OUT}$	±25	mA
$V_{CC}$ or GND Current	$I_{CC}$	±50	mA
Storage Temperature	$T_{STG}$	-65 ~ +150	°C

Note: Absolute maximum ratings are those values beyond which the device could be permanently damaged.

Absolute maximum ratings are stress ratings only and functional device operation is not implied.

■ RECOMMENDED OPERATING CONDITIONS

PARAMETER	SYMBOL	CONDITIONS	MIN	TYP	MAX	UNIT
Supply Voltage	$V_{CC}$		4.5	5.0	5.5	V
Input Voltage	$V_{IN}$		0		5.5	V
Output Voltage	$V_{OUT}$		0		$V_{CC}$	V
Input Transition Rise or Fall Times	$t_R, t_F$	$V_{CC}=3.3V\pm0.3V$				ns/V
		$V_{CC}=5V\pm0.5V$			20	
Operating Temperature	$T_A$		-40	25	125	°C

■ ELECTRICAL CHARACTERISTICS

PARAMETER	SYMBOL	TEST CONDITIONS	MIN	TYP	MAX	UNIT
High-Level Input Voltage	$V_{IH}$	$V_{CC}=4.5V\sim5.5V$	2.0			V
Low-Level Input Voltage	$V_{IL}$	$V_{CC}=4.5V\sim5.5V$			0.8	V
High-Level Output Voltage	$V_{OH}$	$V_{CC}=4.5V, V_{IN}=V_{IH}$ or $V_{IL}, I_{OH}=-50\mu A$	4.4	4.5		V
		$V_{CC}=4.5V, V_{IN}=V_{IH}$ or $V_{IL}, I_{OH}=-8mA$	3.94			
Low-Level Output Voltage	$V_{OL}$	$V_{CC}=4.5V, V_{IN}=V_{IH}$ or $V_{IL}, I_{OL}=50\mu A$		0	0.1	V
		$V_{CC}=4.5V, V_{IN}=V_{IH}$ or $V_{IL}, I_{OL}=8mA$			0.36	V
Input Leakage Current	$I_{I(LEAK)}$	$V_{CC}=5.5V, V_{IN}=V_{IH}$ or $V_{IL}$			±0.1	μA
Quiescent Supply Current	$I_Q$	$V_{CC}=5.5V, V_{IN}=V_{CC}$ or GND, $I_{OUT}=0$			1	μA
Additional Quiescent Supply Current	$\Delta I_Q$	$V_{CC}=5.5V, V_{IN} = 3.4 V$ ; other inputs at $V_{CC}$ or GND, $I_{OUT}=0$			1.35	mA
Input Capacitance	$C_{IN}$			1.5	10	pF

Note: All unused inputs of the device must be held at  $V_{CC}$  or GND to ensure proper device operation.

■ SWITCHING CHARACTERISTICS (Input signal:  $P_{RR}\leq 1MHz, Z_o=50\Omega, t_R\leq 3ns, t_F\leq 3ns.$ )

PARAMETER	SYMBOL	TEST CONDITIONS	MIN	TYP	MAX	UNIT
Propagation Delay Times	$t_{PLH}/ t_{PHL}$	$V_{CC}=4.5V\sim5.5V, C_L = 15 pF$		3.5	5.5	ns
		$V_{CC}=4.5V\sim5.5V, C_L = 50 pF$		4.9	7.5	ns

■ TEST CIRCUIT AND WAVEFORMS

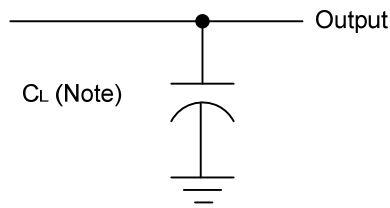

Note:  $C_L$  includes probe and jig capacitance.

Fig.1 Load circuitry for switching times.

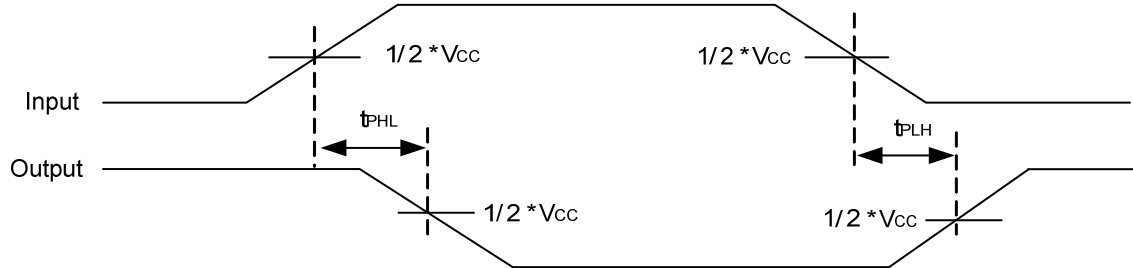

Fig. 2 Propagation delay from input(A and B) to output(Y)

UTC assumes no responsibility for equipment failures that result from using products at values that exceed, even momentarily, rated values (such as maximum ratings, operating condition ranges, or other parameters) listed in products specifications of any and all UTC products described or contained herein. UTC products are not designed for use in life support appliances, devices or systems where malfunction of these products can be reasonably expected to result in personal injury. Reproduction in whole or in part is prohibited without the prior written consent of the copyright owner. The information presented in this document does not form part of any quotation or contract, is believed to be accurate and reliable and may be changed without notice.