

# Self Drive Piezo Transducer (AC)

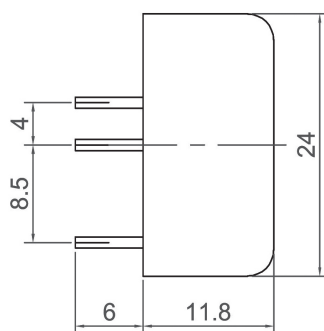

**CIT2412**

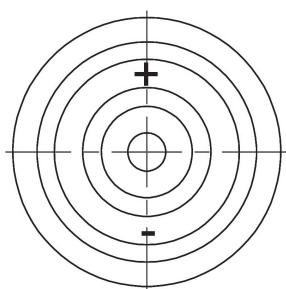
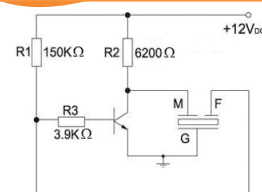

Canopus Part no.	Operating Voltage (VDC)	Rated Voltage (VDC)	Max Rated Current (mA)	Min Sound Output (dBA)	Resonant Frequency (Hz)	Operating Temperature (°C)	Housing	Terminal	Weight (g)
CIT2412H30NP	3 ~ 28	12	10	80 at 30cm	3000 ± 500	-30 ~ +80	Noryl	Pin	3.4



**CIT2507**

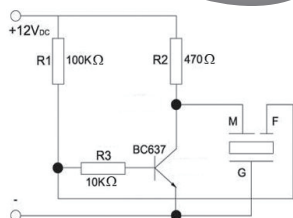
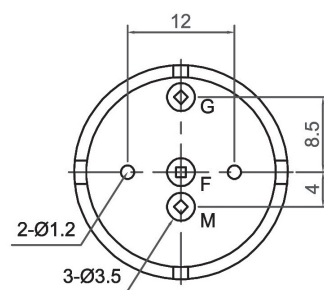
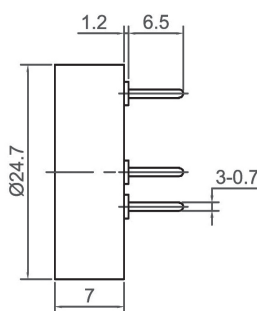
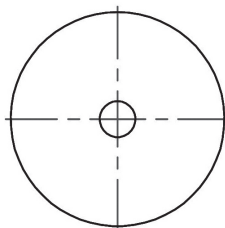

Canopus Part no.	Operating Voltage (VDC)	Rated Voltage (VDC)	Max Rated Current (mA)	Min Sound Output (dBA)	Resonant Frequency (Hz)	Operating Temperature (°C)	Housing	Terminal	Weight (g)
CIT2507H37NP	3 ~ 24	12	20	88 at 10cm	3700 ± 500	-20 ~ +70	Noryl	Pin	2.5
CIT2507H68YP	3 ~ 24	12	20	90 at 10cm	6800 ± 500	-20 ~ +70	Noryl	Pin	2.5

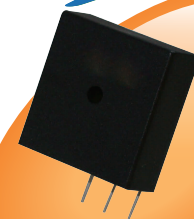
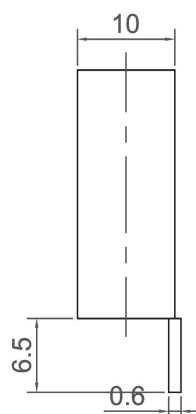
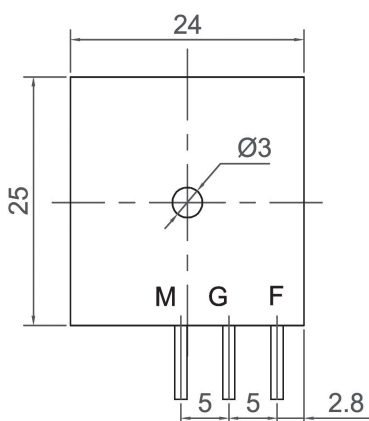

**CIT2510**

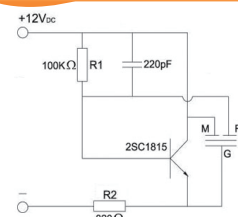

Canopus Part no.	Operating Voltage (VDC)	Rated Voltage (VDC)	Max Rated Current (mA)	Min Sound Output (dBA)	Resonant Frequency (Hz)	Operating Temperature (°C)	Housing	Terminal	Weight (g)
CIT2510H32TP	3 ~ 30	12	20	90 at 10cm	3200 ± 500	-20 ~ +125	PBT	Pin	3.5

**Your Efficient Supplier**  
[www.canopus.com.hk](http://www.canopus.com.hk)

TEL.: (852) 2806 2812

Fax: (852) 2652 2216