

Typical Applications

LNA for Spread Spectrum Applications:

- BLUETOOTH
- HomeRF
- 802.11 WLAN
- 2.5 GHz Radios

Functional Diagram

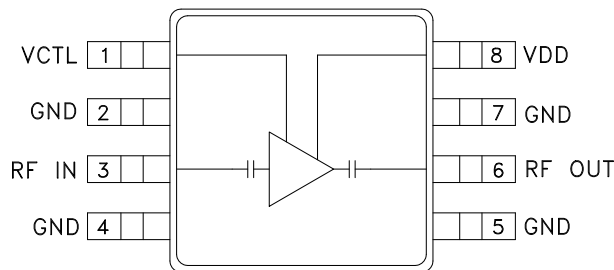

Features

- Gain: 21 dB
- Noise Figure: 2.5 dB
- Gain Adjustment: 30 dB
- Single Positive Supply: +3V
- No External Components
- Ultra Small Package: MSOP8G

General Description

The HMC287MS8 & HMC287MS8E are low cost Low Noise Amplifiers (LNA) offering 21 dB of gain and a 2.5 dB noise figure from a single positive +3V supply that requires only 9 mA. The HMC287MS8 & HMC287MS8E can be used as variable gain LNAs, offering 30 dB of gain control, which is controlled with 0 to 3V analog voltages. The typical output 1 dB compression point is +3 dBm and OIP3 is +7 dBm when in the maximum gain state. The compact LNA design utilizes on-chip matching for repeatable gain and noise figure performance and eliminates the need for external matching circuitry to reduce the overall size of the LNA function.

Electrical Specifications, $T_A = +25^\circ \text{C}$, $V_{dd} = +3V$

Parameter	Min.	Typ.	Max.	Units
Frequency Range	2.3 - 2.5			GHz
Gain	15	21	27	dB
Gain Variation Over Temperature		0.03	0.04	dB/°C
Gain Adjustment Range (Vctl 0 to +3V)		30		dB
Noise Figure (Vctl = 0V)		2.5	3.0	dB
Input Return Loss	5	10		dB
Output Return Loss	3	6		dB
Output 1 dB Compression (P1dB)	-2	3		dBm
Output Third Order Intercept (IP3)	3	7		dBm
Control Voltage (Vctl)	0		Vdd	Vdc
Supply Current (Idd)(Vdd = +3.0 Vdc)		9	15	mA



**GaAs MMIC LOW NOISE AMPLIFIER
with AGC, 2.3 - 2.5 GHz**

**Broadband Gain
& Return Loss, $V_{ctl} = 0V$**

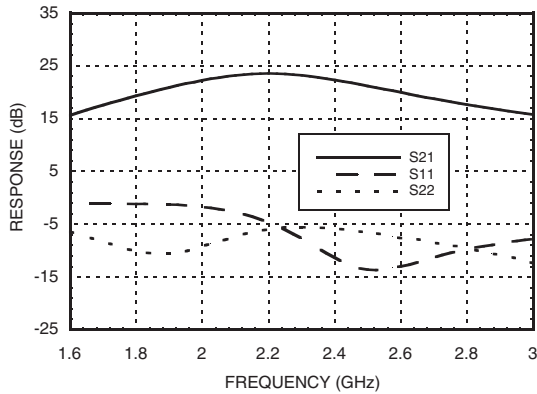

Gain Over Control Voltage Range

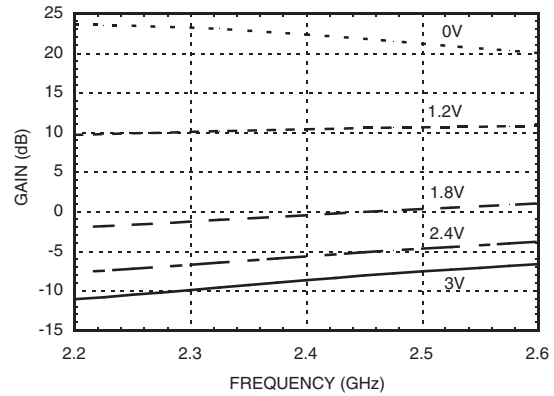

Gain vs. Temperature, $V_{ctl} = 0V$

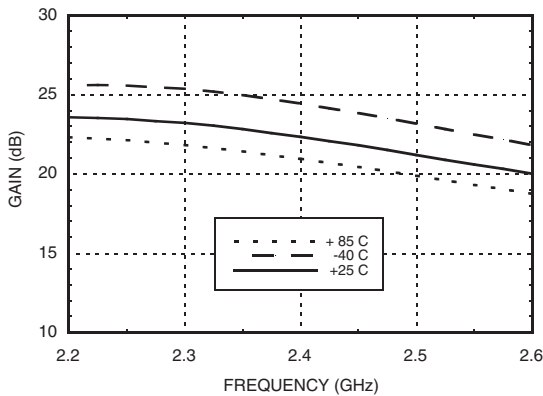

**Noise Figure
vs. Temperature, $V_{ctl} = 0V$**

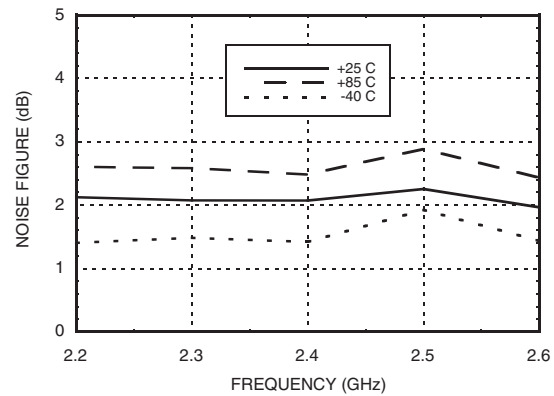

**Input Return Loss
vs. Temperature, $V_{ctl} = 0V$**

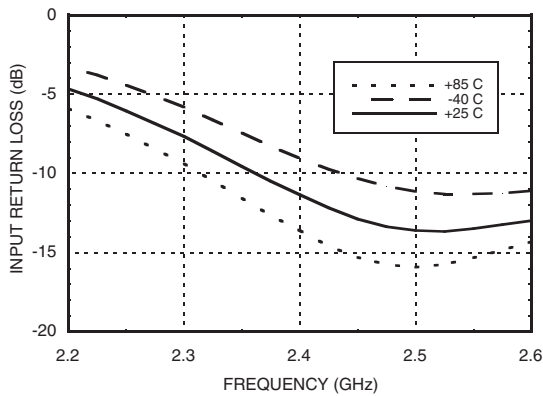

**Output Return Loss
vs. Temperature, $V_{ctl} = 0V$**

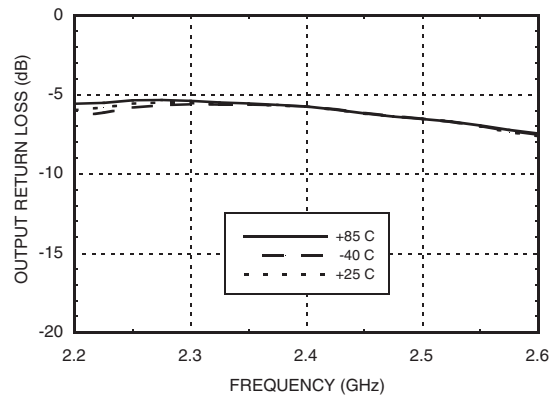

Gain vs. Control Voltage @ 2.4 GHz

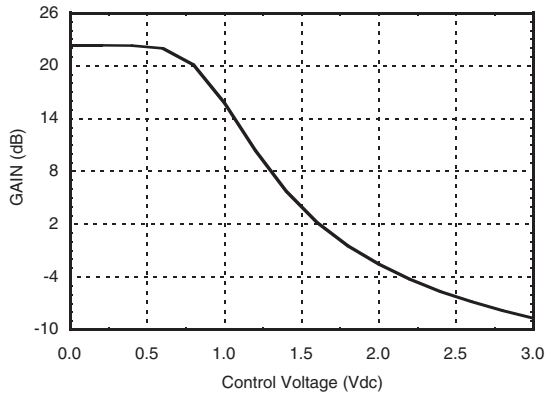

Power Compression @ 2.4 GHz, Vctl = 0V

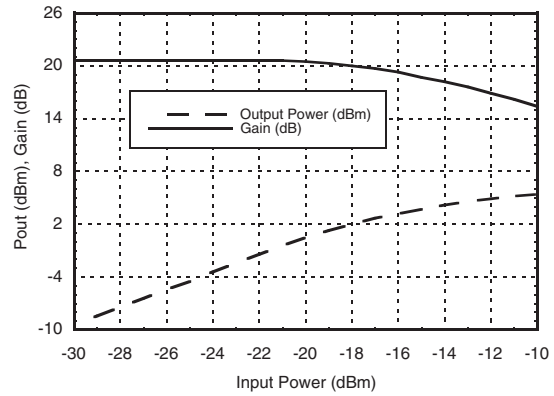

Input Return Loss Over Control Voltage Range

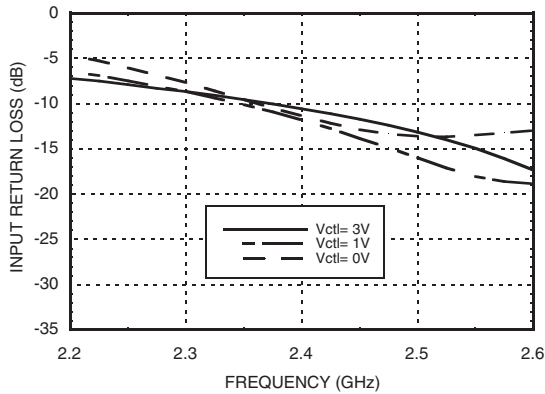

Output Return Loss Over Control Voltage Range

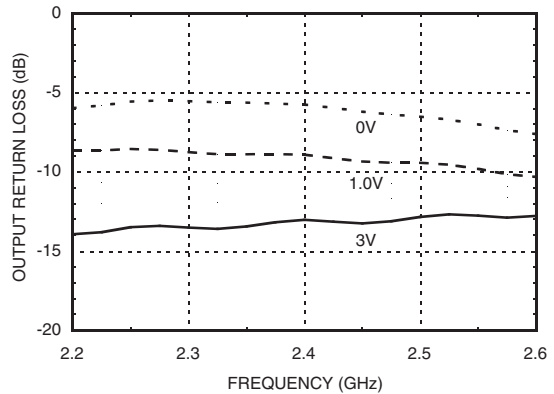

Noise Figure and Output IP3 vs. Control Voltage

VCTL	Frequency = 2.4 GHz	
	Noise Figure	OIP3 (dBm)*
0V	2.5	7.1
1.7V	4.0	-4.4
3.0V	10.0	-12.9

* Two-tone input power = -30 dBm per tone.

Reverse Isolation vs. Temperature, Vctl = 0V

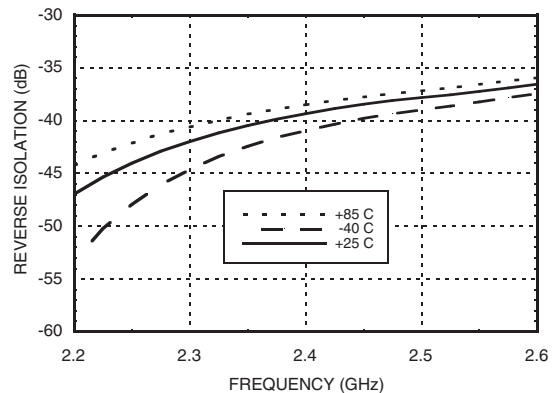

Absolute Maximum Ratings

Drain Bias Voltage (Vdd)	+7 Vdc
Control Voltage Range (Vctl)	-0.2V to Vdd
RF Input Power (RFIN)(Vdd = +3 Vdc)	-7 dBm
Channel Temperature	150 °C
Continuous Pdiss (T = 85 °C) (derate 5.62 mW/°C above 85 °C)	0.365 W
Thermal Resistance (channel to lead)	178 °C/W
Storage Temperature	-65 to +150 °C
Operating Temperature	-40 to +85 °C

Gain Control

Vctl (Vdc)	Gain State	Typical Ictl (uA)
0.0	Maximum	25
1.5	Middle	25
Vdd	Minimum	25



ELECTROSTATIC SENSITIVE DEVICE
OBSERVE HANDLING PRECAUTIONS

Outline Drawing

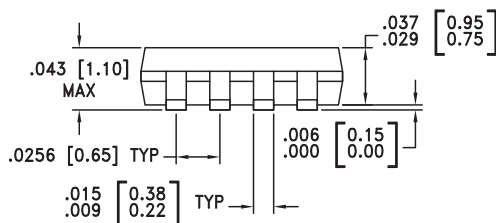
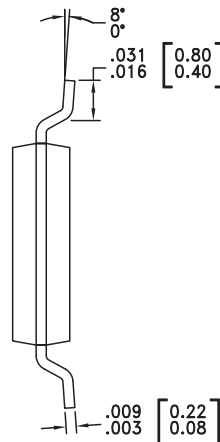
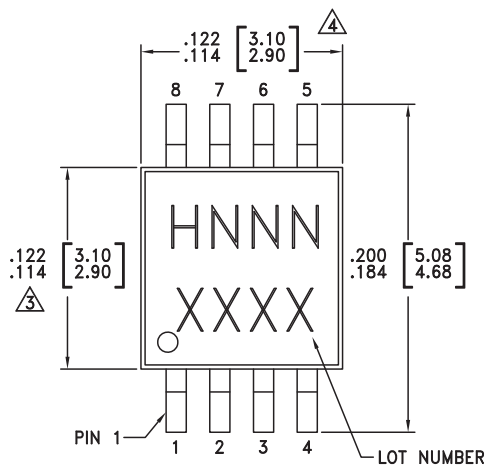

NOTES:

- LEADFRAME MATERIAL: COPPER ALLOY
- DIMENSIONS ARE IN INCHES [MILLIMETERS]
- DIMENSION DOES NOT INCLUDE MOLDFLASH OF 0.15mm PER SIDE.
- DIMENSION DOES NOT INCLUDE MOLDFLASH OF 0.25mm PER SIDE.
- ALL GROUND LEADS MUST BE SOLDERED TO PCB RF GROUND.

Package Information

Part Number	Package Body Material	Lead Finish	MSL Rating	Package Marking ^[3]
HMC287MS8	Low Stress Injection Molded Plastic	Sn/Pb Solder	MSL1 ^[1]	H287 XXXX
HMC287MS8E	RoHS-compliant Low Stress Injection Molded Plastic	100% matte Sn	MSL1 ^[2]	H287 XXXX

[1] Max peak reflow temperature of 235 °C

[2] Max peak reflow temperature of 260 °C

[3] 4-Digit lot number XXXX

For price, delivery, and to place orders, please contact Hittite Microwave Corporation:
20 Alpha Road, Chelmsford, MA 01824 Phone: 978-250-3343 Fax: 978-250-3373
Order On-line at www.hittite.com

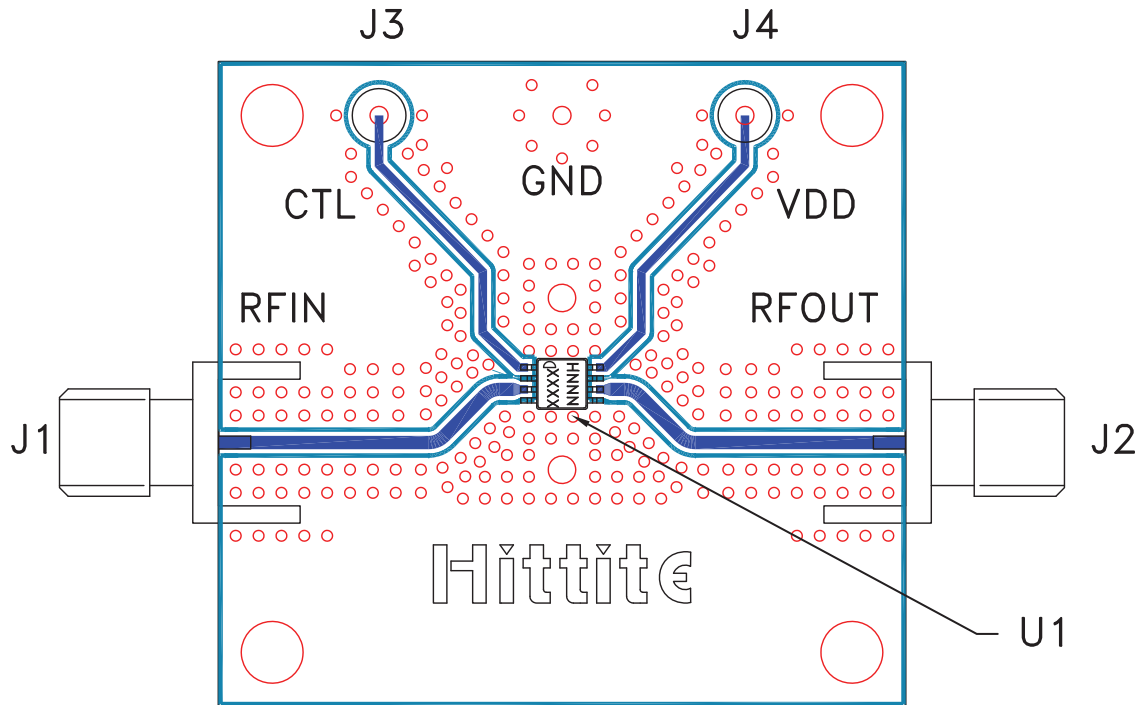
Evaluation PCB

List of Materials for Evaluation PCB 103739 [1]

Item	Description
J1, J2	PCB Mount SMA Connector
J3, J4	DC Pin
U1	HMC287MS8 / HMC287MS8E Amplifier
PCB [2]	Evaluation Board 1.6" x 1.5"

[1] Reference this number when ordering complete evaluation PCB

[2] Circuit Board Material: Rogers 4350

The circuit board used in the final application should use RF circuit design techniques. Signal lines should have 50 ohm impedance while the package ground leads and exposed paddle should be connected directly to the ground plane similar to that shown. A sufficient number of via holes should be used to connect the top and bottom ground planes. The evaluation circuit board shown is available from Hittite upon request.



HMC287MS8 / 287MS8E

GaAs MMIC LOW NOISE AMPLIFIER
with AGC, 2.3 - 2.5 GHz

Notes: