

Specification

NT610 . NT615

All exposed cast aluminum components are made of non corrosive pure aluminum copper free (Aluminum is less than .1% copper content.#356 alloy.)

Finish: All polyester powder baked coatings preceded with a 5 baths preparation process. Meets military grade MIL-C781706 with a 2000 hours salt spray test.

- Pulse rated medium base porcelain socket.
- 75W/600V thermoplastic compact fluorescent socket.
- One-piece molded silicone gasket with memory retention.
- High power factor CWA ballast. Or 98% P.F.electronic smart ballast with end of life detection for compact fluorescent.
- All stainless steel hardware.
- All Moving and removable parts are sealed with a memory retention silicone gasket.

- 1- One piece cast aluminum luminaire housing.
- 2- Semi-specular aluminum reflector.
- 3- White translucent acrylic diffuser.
- 4- **NT610:** One piece cast aluminum cross blades guard.
NT615: Open cast aluminum lens frame.

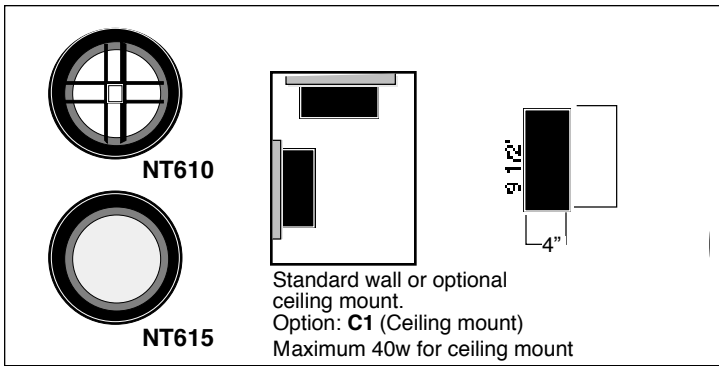
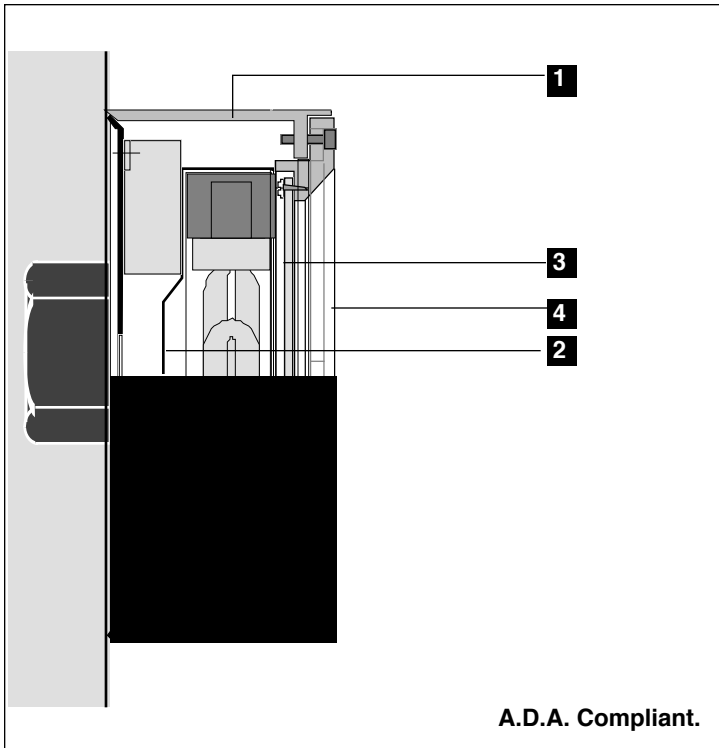

Photometry

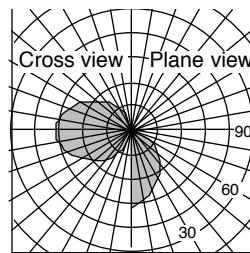

Separate updated technical specification sheets with related models and light sources with I.E.S formatted photometry are available on www.luminis.com.

Certification

UL. Wet Location.

Mounting

Max. Max. weight: 7 lbs. Installation: Mounts over a standard 4" octagonal electrical box with 3 1/2" c/c mounting holes.

For options details and specifications, please refer to page 72







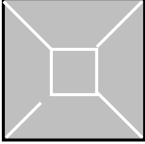
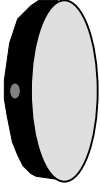

Model#	Light source selection	Voltage	Finish	Options
<input type="checkbox"/> NT610 <input type="checkbox"/> NT615	 CF (Gx24q) Single lamp <input type="checkbox"/> F118 <input type="checkbox"/> F126 <input type="checkbox"/> F132 CF (Gx24q) Two lamps <input type="checkbox"/> F218 <input type="checkbox"/> F226 (Lamps by others)	120 V Standard factory prewired (If no voltage is specified) COMP. FLUO. Smart ballast 120/277 <input type="checkbox"/> 347 V (To specify)	(Refer to color chart) Standard selection <input type="checkbox"/> WHT: Snow white <input type="checkbox"/> BKT: Jet black <input type="checkbox"/> BZT: Bronze <input type="checkbox"/> GRT: Titanium gray <input type="checkbox"/> DGT: Gun metal <input type="checkbox"/> CHT: Champagne <input type="checkbox"/> MST: Matte silver <input type="checkbox"/> GNT: Forest green Optional colors <input type="checkbox"/> CS: Custom color <input type="checkbox"/> RAL: RAL# color	<input type="checkbox"/> SWK: Surface mount connection box. <input type="checkbox"/> C1: Surface ceiling mounting kit. Max. 40W Accessories

Luminaires may be altered for design improvements or discontinued without prior notice.

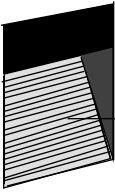
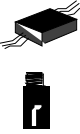
General notes:

Please specify selected option as a suffix to the specified model number. ex:NT100-M100-WHT-PC1

Each model is provided with a listing of compatible options. Some options may not be compatible when used in the same luminaire. This information is indicated when it is applicable.

<p>Square lens Diffuser.</p> <p>Option: PC6</p>  <p>High impact acrylic lens diffuser. Max: 50W</p>	<p>Surface connection box</p> <p>Option: SWK</p>  <p>1 1/2" deep luminaire matching connection box for surface conduit feed. (2) 7/8" dia. K.O. @ 180 deg.</p>	<p>White translucent round diffuser.</p> <p>Option: PC1</p>  <p>Polycarbonate lens diffuser Max: 50W</p>	<p>Alternate regressed reflector.</p> <p>Option: R2</p>  <p>Satin anodized corrugated reflector surface.</p>
<p>Quartz lamp restrike</p> <p>Option: QRS</p>  <p>Quartz restrike standby lamp kit max. 100w DC bayonet type</p>	<p>Ceiling surface mounting</p> <p>Option: C</p>  <p>Ceiling surface mount conversion kit. Maximum wattage 2x32w compact fluorescent. (factory installed.)</p>	<p>White translucent round diffuser.</p> <p>Option: PC2</p>  <p>High impact acrylic lens diffuser. Max: 50W</p>	<p>White translucent oblong diffuser.</p> <p>Option: PCO</p>  <p>Polycarbonate lens diffuser Max: 50W</p>
<p>In line fuse</p> <p>Option: FS</p>  <p>3 Amps. in line protection fuse, factory installed with the pole or inside fixture when pole is not required.</p>	<p>Emergency line quartz lamp</p> <p>Option: QS</p>  <p>Quartz lamp socket for separate emergency line. Max. 100w DC bayonet type</p>		

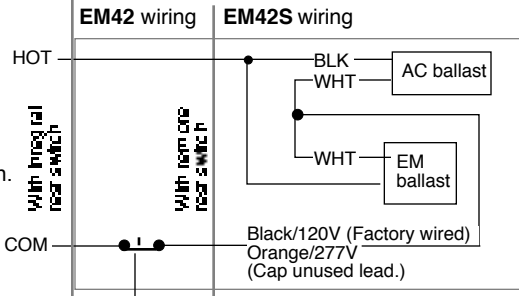
<p>Emergency battery back-up</p> <p>EM42 / EM42S</p> <p>One lamp:</p> <p>26w: 450 Lmns.. 32w: 575 Lmns.. 42w: 750 Lmns.</p> <p>Time: 90 Mnts -120/277V / T 0° C</p> <p>For 57w & 70w: (Remote installation only) Consult factory</p>	<p>EM Ballast wiring diagram for 120V factory connection.</p>	 <p>EM42 wiring EM42S wiring</p> <p>With integral test switch With remote test switch</p> <p>BLK - AC ballast WHT - EM ballast</p> <p>Black/120V (Factory wired) Orange/277V (Cap unused lead.)</p> <p>Single pole test switch (Breaking the connection)</p>	<p>Note:</p> <p>EM42 option is supplied with integral test switch and pilot light.</p> <p>EM42S is supplied with additional wiring for external remotely installed test switch and pilot light.</p> <p>Please refer to luminaire specification sheet option listing.</p>
--	---	--	--

Luminaires may be altered for design improvements or discontinued without prior notice.