



Aluminum electrolytic capacitors

Single-ended capacitors

Series/Type: B43866
Date: December 2006



Single-ended capacitors

B43866

Up to 125 °C

**Long-life grade capacitors
for professional electronic ballasts**

Applications

- Energy-saving lamps
- Electronic ballasts
- Power supplies
- Automotive applications

Features

- High ripple current capability
- Wide temperature range up to 125 °C

Construction

- Radial leads
- Charge-discharge proof, polar
- Aluminum case with insulating sleeve
- Minus pole marking on the insulating sleeve
- Case with safety vent

Delivery mode

Terminal configurations and packing:

- Bulk
- Taped, Ammo pack
- Cut
- Kinked
- PAPR (protection against polarity reversal):
crimped leads, J leads, bent leads

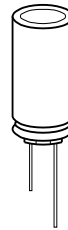

Refer to chapter "Single-ended capacitors - Taping, packing and lead configurations" for further details and ordering example.



B43866

Up to 125 °C



Specifications and characteristics in brief

Rated voltage V_R	160 ... 350 V DC			
Surge voltage V_S	$1.1 \cdot V_R$			
Rated capacitance C_R	3.3 ... 220 μ F			
Capacitance tolerance	$\pm 20\% \triangleq M$			
Dissipation factor $\tan \delta$ (20 °C, 120 Hz)	$V_R \leq 250$ V DC: $\tan \delta = 0.20$ $V_R \geq 350$ V DC: $\tan \delta = 0.25$			
Leakage current I_{leak} (20 °C, 5 min)	$I_{leak} = 0.03 \mu A \cdot \left(\frac{C_R}{\mu F} \cdot \frac{V_R}{V} \right) + 15 \mu A$			
Self-inductance ESL	Diameter (mm)	≤ 12.5	16	18
	ESL (nH)	20	26	34
Useful life 125 °C, V_R , $I_{AC,R}$	> 2000 h			
Requirements	$\Delta C/C$	$\leq \pm 35\%$ of initial value		
	$\tan \delta$	≤ 3 times initial specified limit		
	I_{leak}	\leq initial specified limit		
Voltage endurance test 125 °C, V_R	2000 h			
Post test requirements	$\Delta C/C$	$\leq \pm 30\%$ of initial value		
	$\tan \delta$	≤ 2 times initial specified limit		
	I_{leak}	\leq initial specified limit		
Vibration resistance test	To IEC 60068-2-6, test Fc: Displacement amplitude 0.75 mm, frequency range 10 ... 2000 Hz, acceleration max. 20 g, duration 3 \times 2 h. Capacitor rigidly clamped by the aluminum case.			
IEC climatic category	To IEC 60068-1:			
	$V_R \leq 250$ V: 40/125/56 (–40 °C/+125 °C/56 days damp heat test) $V_R \geq 350$ V: 25/125/56 (–25 °C/+125 °C/56 days damp heat test)			
Sectional specification	IEC 60384-4			

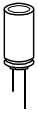

B43866

Up to 125 °C

Dimensional drawings

With stand-off rubber seal

Diameters (mm): 10, 12.5, 16, 18

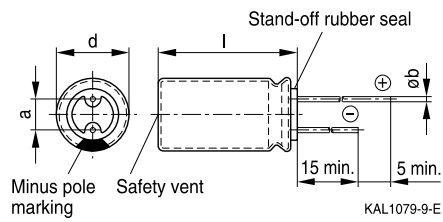

With flat rubber seal

Diameter (mm): 20

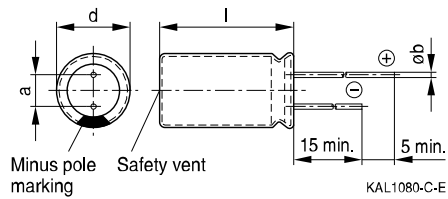

Dimensions and weights

Dimensions (mm)				Approx. weight
d +0.5	l	a ±0.5	b	g
10	16 +1.0	5.0	0.60 ±0.05	1.9
10	20 +2.0	5.0	0.60 ±0.05	2.6
12.5	20 +2.0	5.0	0.60 ±0.05	3.6
12.5	25 +2.0	5.0	0.60 ±0.05	4.5
16	20 +2.0	7.5	0.80 ±0.05	5.5
16	25 +2.0	7.5	0.80 ±0.05	7.5
16	31.5 +2.0	7.5	0.80 ±0.05	7.8
18	20 +2.0	7.5	0.80 ±0.1	8.0
20	20 +2.0	10.0	1.0 ±0.1	10.0
20	25 +2.0	10.0	1.0 ±0.1	12.0



B43866

Up to 125 °C



Overview of available types

V _R (V DC)	160	200	250	300	350
	Case dimensions d × l (mm)				
C _R (μF)					
3.3					10 × 20
3.9					10 × 20
4.7					10 × 20
6.8					12.5 × 20
10	10 × 16	10 × 20	10 × 20		12.5 × 25
15		10 × 20	12.5 × 20		
22	10 × 20	12.5 × 20	12.5 × 20	12.5 × 20	16 × 20
33	12.5 × 20	12.5 × 25	12.5 × 25	16 × 20	16 × 20
47	12.5 × 25	12.5 × 25	16 × 20	18 × 20	20 × 20
68	16 × 20	16 × 25			20 × 25
100	16 × 25	16 × 31.5	20 × 25	20 × 25	
220	16 × 31.5	18 × 35			

Other voltage and capacitance ratings are available upon request.



B43866

Up to 125 °C

Technical data and ordering codes

C _R	Case dimensions d × l	ESR _{max} 120 Hz 20 °C Ω	ESR _{max} 120 Hz -25 °C Ω	Z _{max} 100 kHz 20 °C Ω	I _{AC,R} 100 kHz 125 °C mA	I _{AC,max} 100 kHz 105 °C mA	Ordering code (composition see below)
V_R = 160 V DC							
10	10 × 16	1162	33.2	6.97	150	210	B43866A1106M***
22	10 × 20	529	15.1	3.17	225	315	B43866A1226M***
33	12.5 × 20	350	10.0	2.10	315	441	B43866A1336M***
47	12.5 × 25	249	7.1	1.49	435	609	B43866A1476M***
68	16 × 20	172	4.9	1.03	533	746	B43866A1686M***
100	16 × 25	116	3.3	0.69	720	1008	B43866A1107M***
220	16 × 31.5	53	1.5	0.32	780	1092	B43866A1227M***
V_R = 200 V DC							
10	10 × 20	1162	33.2	6.97	158	221	B43866A2106M***
15	10 × 20	774	22.1	4.64	195	273	B43866A2156M***
22	12.5 × 20	529	15.1	3.17	278	389	B43866A2226M***
33	12.5 × 25	350	10.0	2.10	360	504	B43866A2336M***
47	12.5 × 25	249	7.1	1.49	435	609	B43866A2476M***
68	16 × 25	172	4.9	1.03	548	767	B43866A2686M***
100	16 × 31.5	116	3.3	0.69	765	1071	B43866A2107M***
220	18 × 35	53	1.5	0.32	825	1155	B43866A2227M***
V_R = 250 V DC							
10	10 × 20	1162	33.2	6.97	158	221	B43866F2106M***
15	12.5 × 20	774	22.1	4.64	195	273	B43866F2156M***
22	12.5 × 20	295	8.4	1.77	310	434	B43866W2226M***
33	12.5 × 25	350	10.0	2.10	360	504	B43866F2336M***
47	16 × 20	138	4.0	0.83	530	742	B43866W2476M***
100	20 × 25	65	1.9	0.39	920	1288	B43866W2107M***
V_R = 300 V DC							
22	12.5 × 20	295	8.4	1.77	310	434	B43866W3226M***
33	16 × 20	197	5.6	1.18	450	630	B43866W3336M***
47	18 × 20	138	4.0	0.83	560	784	B43866W3476M***
100	20 × 25	65	1.9	0.39	920	1288	B43866W3107M***

Composition of ordering code

*** = Version

- 000 = for standard leads, bulk
- 001 = for kinked leads, bulk (for Ø ≥ 10 mm)
- 002 = for cut leads, bulk (for Ø ≥ 10 mm)
- 003 = for crimped leads, blister (for Ø ≥ 16 mm)
- 004 = for J leads, blister (from d × l = 10 × 16 mm to 18 × 25 mm)
- 008 = for taped leads, Ammo pack, lead spacing F = 5.0 mm (from d × l = 10 × 16 mm to 12.5 × 25 mm)
- 009 = for taped leads, Ammo pack, lead spacing F = 7.5 mm (from d × l = 16 × 20 mm to 18 × 25 mm)
- 012 = for bent 90° leads, blister (for Ø 16 and 18 mm)



B43866

Up to 125 °C



Technical data and ordering codes

C _R	Case dimensions	ESR _{max} 120 Hz	ESR _{max} 120 Hz	Z _{max} 100 kHz	I _{AC,R} 100 kHz	I _{AC,max} 100 kHz	Ordering code
120 Hz	d × l	120 Hz	120 Hz	100 kHz	100 kHz	100 kHz	(composition see below)
20 °C	mm	-25 °C	20 °C	20 °C	125 °C	105 °C	
μF		Ω	Ω	Ω	mA	mA	
V_R = 350 V DC							
3.3	10 × 20	4396	125.6	26.38	90	126	B43866A4335M***
3.9	10 × 20	3721	106.3	22.32	105	147	B43866A4395M***
4.7	10 × 20	3087	88.2	18.52	120	168	B43866A4475M***
6.8	12.5 × 20	2142	61.2	12.85	143	200	B43866A4685M***
10	12.5 × 25	3087	88.2	18.52	202	283	B43866A4106M***
22	16 × 20	337	9.6	2.02	355	497	B43866W4226M***
33	16 × 20	225	6.4	1.35	450	630	B43866W4336M***
47	20 × 20	158	4.5	0.95	580	812	B43866W4476M***
68	20 × 25	109	3.1	0.66	750	1050	B43866W4686M***

Composition of ordering code

*** = Version

- 000 = for standard leads, bulk
- 001 = for kinked leads, bulk (for Ø ≥ 10 mm)
- 002 = for cut leads, bulk (for Ø ≥ 10 mm)
- 003 = for crimped leads, blister (for Ø ≥ 16 mm)
- 004 = for J leads, blister (from d × l = 10 × 16 mm to 18 × 25 mm)
- 008 = for taped leads, Ammo pack, lead spacing F = 5.0 mm (from d × l = 10 × 16 mm to 12.5 × 25 mm)
- 009 = for taped leads, Ammo pack, lead spacing F = 7.5 mm (from d × l = 16 × 20 mm to 18 × 25 mm)
- 012 = for bent 90° leads, blister (for Ø 16 and 18 mm)

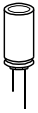

B43866

Up to 125 °C

Useful life

depending on ambient temperature T_A under ripple current operating conditions¹⁾

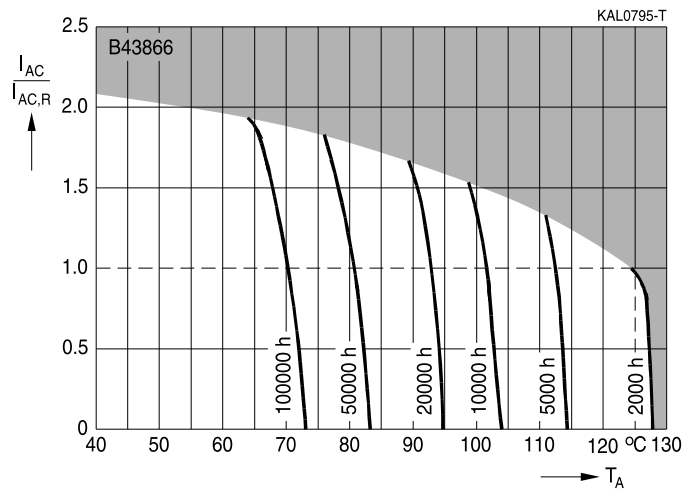

Frequency factor of permissible ripple current I_{AC} versus frequency f

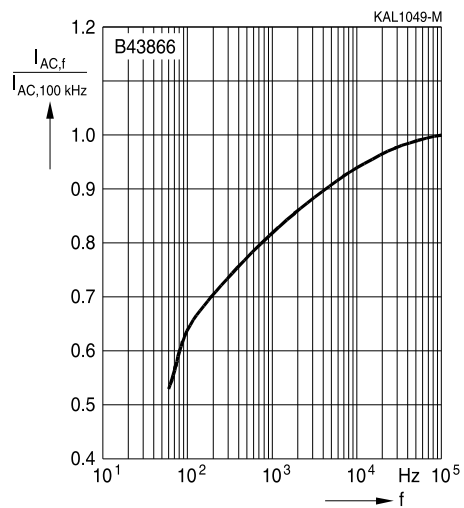

1) Refer to chapter "General technical information, 5.3 Calculation of useful life" for an explanation on how to interpret the useful life graphs.



B43866

Up to 125 °C



Taping, packing and lead configurations

Taping

Single-ended capacitors are available taped in Ammo pack from diameter 5 to 18 mm as follows:

Lead spacing F = 2.5 mm (∅ d = 5 ... 6.3 mm)

Lead spacing F = 3.5 mm (∅ d = 8 mm)

Lead spacing F = 5.0 mm (∅ d = 5 ... 12.5 mm)

Lead spacing F = 7.5 mm (∅ d = 16 ... 18 mm).

Lead spacing 2.5 mm (∅ d = 5 ... 6.3 mm)

Last 3 digits of ordering code: 007

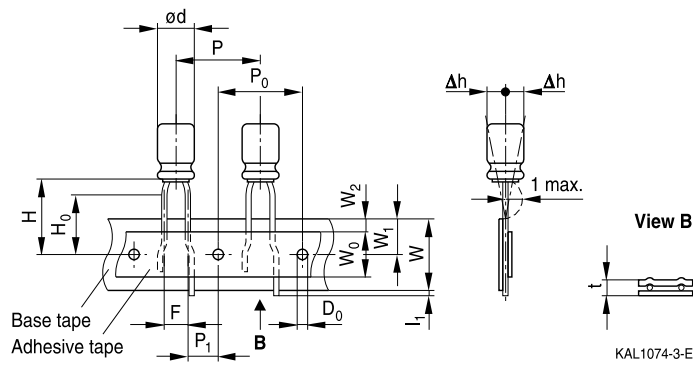

Dimensions in mm

∅ d	F	H	W	W ₀	W ₁	W ₂	H ₀	P	P ₀	P ₁	l ₁	t	Δh	D ₀
5 — 6.3	2.5	18.5	18.0	5.5	9.0	1.5	16.0	12.7	12.7	5.1	1.0	0.7	1.0	4.0
Tolerance	+0.8 -0.2	±0.75	±0.5	min.	±0.5	max.	±0.5	±1.0	±0.2	±0.5	max.	±0.2	max.	±0.2

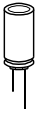

B43866

Up to 125 °C

Lead spacing 3.5 mm (∅ d = 8 mm)

Last 3 digits of ordering code: 006

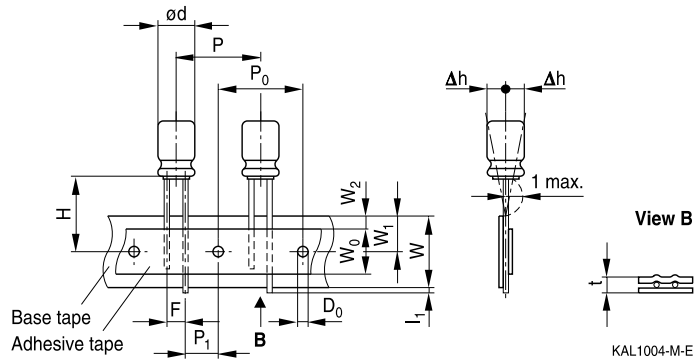

Dimensions in mm

∅ d	F	H	W	W ₀	W ₁	W ₂	P	P ₀	P ₁	l ₁	t	Δh	D ₀
8	3.5	18.5	18.0	12.5	9.0	1.5	12.7	12.7	4.6	1.0	0.7	1.0	4.0
Tolerance	+0.8 -0.2	1.0	±0.5	min.	±0.5	max.	±1.0	±0.2	±0.5	max.	±0.2	max.	±0.2



B43866

Up to 125 °C



Lead spacing 5.0 mm (∅ d = 5 ... 8 mm)

Last 3 digits of ordering code: 008

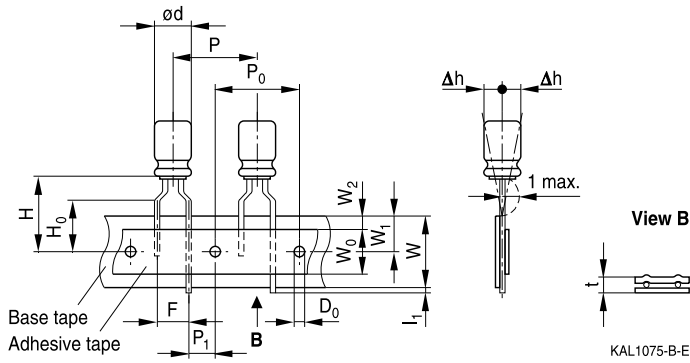

KAL1075-B-E

Lead spacing 5.0 mm (∅ d = 10 ... 12.5 mm)

Last 3 digits of ordering code: 008

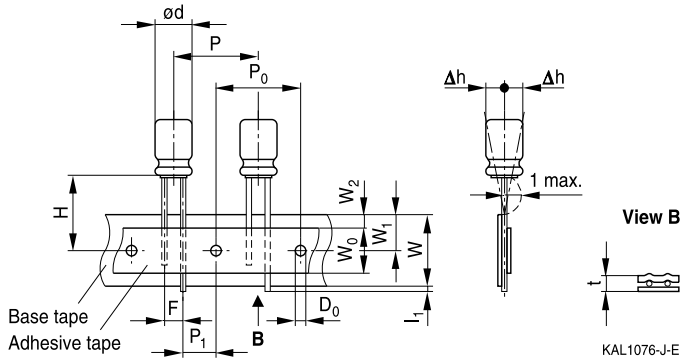

KAL1076-J-E

Dimensions in mm

∅ d	F	H	W	W ₀	W ₁	W ₂	H ₀	P	P ₀	P ₁	L ₁	t	Δh	D ₀
5	5.0	18.5	18.0	5.5	9.0	1.5	16.0	12.7	12.7	3.85	1.0	0.7	1.0	4.0
6.3		20.0	18.0	12.5	9.0	1.5	16.0	12.7	12.7	3.85	1.0	0.7	1.0	4.0
8	19.0	—					12.7	12.7	3.85					
10	19.0	—					15.0	15.0	5.0					
12.5	—	—	—	—	—	—	—	—	—	—	—	—	—	—
Tolerance	+0.8 -0.2	±0.75	±0.5	min.	±0.5	max.	±0.5	±1.0	±0.2	±0.5	max.	±0.2	max.	±0.2

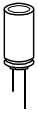

B43866

Up to 125 °C

Lead spacing 7.5 mm (∅ d = 16 ...18 mm)

Last 3 digits of ordering code: 009

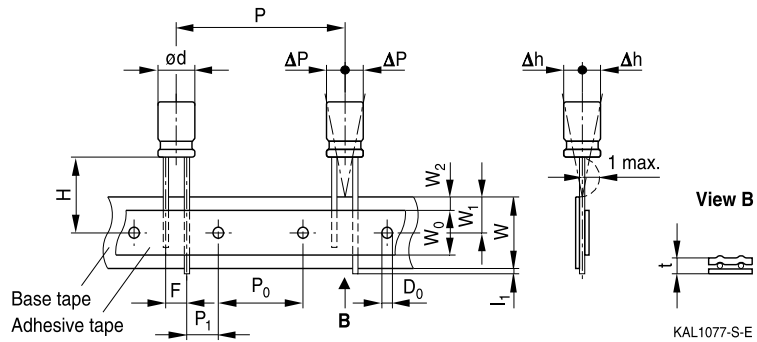

Dimensions in mm

∅ d	F	H	W	W ₀	W ₁	W ₂	P	P ₀	P ₁	l ₁	t	ΔP	Δh	D ₀
16	7.5	18.5	18.0	12.5	9.0	1.5	30.0	15.0	3.75	1.0	0.7	0	0	4.0
18 *)														
Tolerance	±0.8	-0.5 +0.75	±0.5	min.	±0.5	max.	±1.0	±0.2	±0.5	max.	±0.2	±1.0	±1.0	±0.2

*) Available only for case dimensions 18 × 20, 18 × 25 and 18 × 31.5 mm



B43866

Up to 125 °C



Packing units and box dimensions

Ammo pack

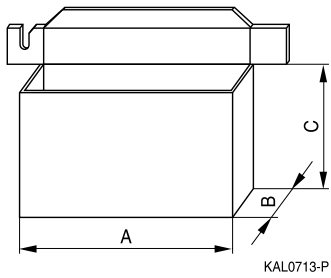

Case size d × l mm	Dimensions (mm)			Packing units pcs.
	A _{max}	B _{max}	C _{max}	
5 × 11	345	55	240	2000
6.3 × 11	345	55	290	2000
8 × 11.5	345	55	240	1000
10 × 12.5	345	55	280	750
10 × 16	345	60	200	500
10 × 20	345	60	200	500
12.5 × 20	345	65	280	500
12.5 × 25	345	65	280	500
12.5 × 25	345	65	280	500
12.5 × 30	345	65	275	500
16 × 20	315	65	275	300
16 × 25	315	65	275	300
16 × 31.5	315	65	275	300
18 × 20	315	65	275	250
18 × 25	315	65	275	250
18 × 31.5	315	65	275	250

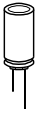

B43866

Up to 125 °C

Kinked or cut leads

Single-ended capacitors are available with kinked or cut leads. Other lead configurations also available upon request.

Kinked leads

Last 3 digits of ordering code: 001

With stand-off rubber seal

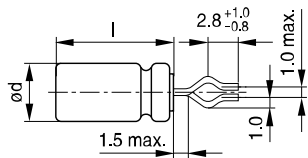

KAL1081-K

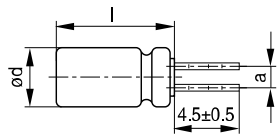

KAL1083-2

With flat rubber seal

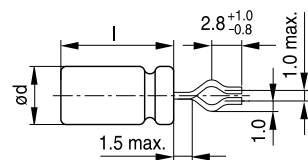

KAL1082-T

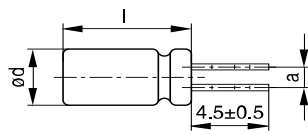

KAL1084-A

Case size d × l (mm)	Dimensions (mm) a ± 0.5
10 × 20	5.0
12.5 × 20	5.0
12.5 × 25	5.0
12.5 × 30	5.0
12.5 × 35	5.0
12.5 × 40	5.0
16 × 20	7.5
16 × 25	7.5
16 × 31.5	7.5
18 × 20	7.5
18 × 25	7.5
18 × 31.5	7.5
18 × 35	7.5
18 × 40	7.5
20 × 20	10.0
20 × 25	10.0
20 × 40	10.0
22 × 30	10.0
22 × 35	10.0
22 × 40	10.0



B43866

Up to 125 °C



Cut leads

Last 3 digits of ordering code: 002

With stand-off rubber seal

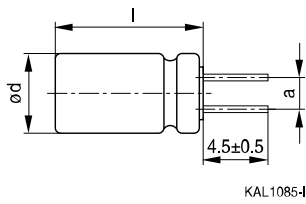

With flat rubber seal

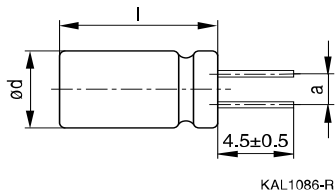

Case size $d \times l$ (mm)	Dimensions (mm) $a \pm 0.5$
10 × 12.5	5.0
10 × 16	5.0
10 × 20	5.0
12.5 × 20	5.0
12.5 × 25	5.0
12.5 × 30	5.0
12.5 × 35	5.0
12.5 × 40	5.0
16 × 20	7.5
16 × 25	7.5
16 × 31.5	7.5
18 × 20	7.5
18 × 25	7.5
18 × 31.5	7.5
18 × 35	7.5
18 × 40	7.5
20 × 20	10.0
20 × 25	10.0
20 × 40	10.0



B43866

Up to 125 °C

PAPR leads (Protection Against Polarity Reversal)

These lead configurations ensure correct placement of the capacitor on the PCB with regard to polarity. PAPR leads are available for diameters from 10 mm up to 20 mm.

There are three configurations available: Crimped leads, J leads, bent 90° leads

Crimped leads

Last 3 digits of ordering code: 003

With stand-off rubber seal

With flat rubber seal

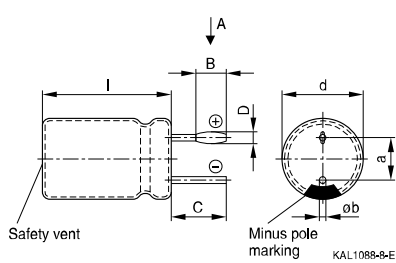
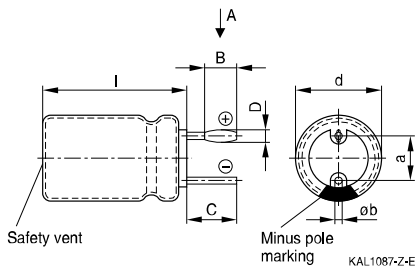

Suggestion for PCB hole diameter

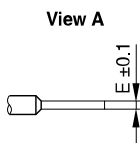

Suggestion for PCB hole diameter, wire ø0.8 mm

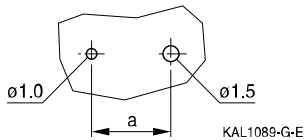

Suggestion for PCB hole diameter, wire ø1.0 mm

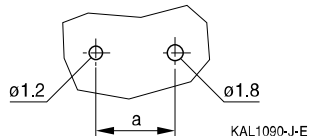

Case size d × l (mm)	Dimensions (mm)					
	B ±0.2	C ±0.5	D ±0.1	E ±0.1	a ±0.5	Øb
16 × 20	1.5	3.0	1.3	0.3	7.5	0.8 ±0.05
16 × 25	1.5	3.0	1.3	0.3	7.5	0.8 ±0.05
16 × 31.5	1.5	3.0	1.3	0.3	7.5	0.8 ±0.05
18 × 20	1.5	3.0	1.3	0.3	7.5	0.8 ±0.1
18 × 25	1.5	3.0	1.3	0.3	7.5	0.8 ±0.1
18 × 31.5	1.5	3.0	1.3	0.3	7.5	0.8 ±0.1
18 × 35	1.5	3.0	1.3	0.3	7.5	0.8 ±0.1
18 × 40	1.5	3.0	1.3	0.3	7.5	0.8 ±0.1
20 × 20	1.5	3.0	1.6	0.3	10.0	1.0 ±0.1
20 × 25	1.5	3.0	1.6	0.3	10.0	1.0 ±0.1
20 × 40	1.5	3.0	1.6	0.3	10.0	1.0 ±0.1



B43866

Up to 125 °C



J leads

Last 3 digits of ordering code: 004

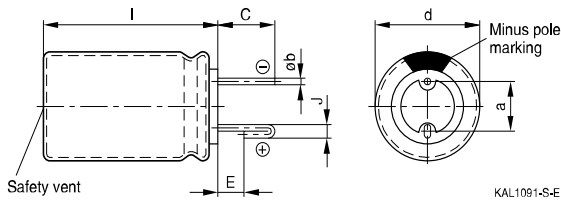

Suggestion for PCB hole diameter

Suggestion for PCB hole diameter,
wire $\varnothing 0.6$ mm

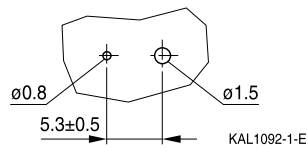

Suggestion for PCB hole diameter,
wire $\varnothing 0.8$ mm

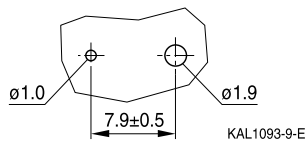

Case size $d \times l$ (mm)	Dimensions (mm)				
	$C \pm 0.5$	$E \pm 0.5$	$J \pm 0.2$	$a \pm 0.5$	$\varnothing b$
10 × 12.5	3.2	0.7	1.2	5.0	0.6 ±0.05
10 × 16	3.2	0.7	1.2	5.0	0.6 ±0.05
10 × 20	3.2	0.7	1.2	5.0	0.6 ±0.05
12.5 × 20	3.2	0.7	1.2	5.0	0.6 ±0.05
12.5 × 25	3.2	0.7	1.2	5.0	0.6 ±0.05
16 × 20	3.5	0.7	1.6	7.5	0.8 ±0.05
16 × 25	3.5	0.7	1.6	7.5	0.8 ±0.05
16 × 31.5	3.5	0.7	1.6	7.5	0.8 ±0.05
18 × 20	3.5	0.7	1.6	7.5	0.8 ±0.1
18 × 25	3.5	0.7	1.6	7.5	0.8 ±0.1
18 × 31.5	3.5	0.7	1.6	7.5	0.8 ±0.1
18 × 35	3.5	0.7	1.6	7.5	0.8 ±0.1



B43866

Up to 125 °C

Bent 90° leads for horizontal mounting pinning

Last 3 digits of ordering code: 012

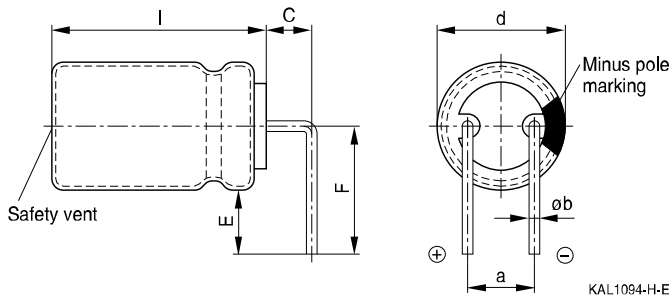

Case size $d \times l$ (mm)	Dimensions (mm)				
	$C \pm 0.5$	$E \pm 0.5$	$F \pm 0.5$	$a \pm 0.5$	$\varnothing b$
16 × 20	4.0	4.0	12.0	7.5	0.8 ±0.05
16 × 25	4.0	4.0	12.0	7.5	0.8 ±0.05
16 × 31.5	4.0	4.0	12.0	7.5	0.8 ±0.05
18 × 20	4.0	4.0	13.0	7.5	0.8 ±0.1
18 × 25	4.0	4.0	13.0	7.5	0.8 ±0.1
18 × 31.5	4.0	4.0	13.0	7.5	0.8 ±0.1
18 × 35	4.0	4.0	13.0	7.5	0.8 ±0.1
18 × 40	4.0	4.0	13.0	7.5	0.8 ±0.1

Bent leads for diameter 12.5 mm available upon request.



B43866

Up to 125 °C



Overview of packing units and code numbers for case sizes 5 × 11 ... 16 × 31.5

Case size d × l mm	Standard, bulk pcs.	Taped, Ammo pack pcs.	Kinked leads, bulk pcs.	Cut leads, bulk pcs.	PAPR				
					Crimped leads pcs.	J leads pcs.	Bent 90° leads, blister pcs.		
5 × 11	2000	2000	–	–	–	–			
6.3 × 11	2500	2000	–	–	–	–			
8 × 11.5	1000	1000	–	–	–	–			
10 × 12.5	1000	750	–	1000	–	675			
10 × 16	100	500	–	1000	–	675			
10 × 20	500	500	500	500	–	500			
12.5 × 20	350	500	350	350	–	300	¹⁾		
12.5 × 25	250	500	500	500	–	225	¹⁾		
12.5 × 30	200	500	175	175	–	180	¹⁾		
12.5 × 35	175	-	175	175	–	150	¹⁾		
12.5 × 40	175	-	175	175	–	150	¹⁾		
16 × 20	250	300	200	200	200	200	120		
16 × 25	250	300	200	200	200	200	120		
16 × 31.5	200	300	250	250	344	344	120		
The last three digits of the complete ordering code state the lead configuration	000	Code	F (mm)	d (mm)	001	002	003	004	012
		006	3.5	8					
		007	2.5	5...6.3					
		008	5	5...12.5					
		009	7.5	16...18					

1) Available upon request



B43866

Up to 125 °C

Overview of packing units and code numbers for case sizes 18 × 20 ... 25 × 40

Case size d × l	Standard, bulk	Taped, Ammo pack	Kinked leads, bulk	Cut leads, bulk	PAPR				
					Crimped leads	J leads	Bent 90° leads, blister		
mm	pcs.	pcs.	pcs.	pcs.	pcs.	pcs.	pcs.		
18 × 20	175	250	175	175	200	200	120		
18 × 25	150	250	150	150	200	200	120		
18 × 31.5	100	250	100	100	150	150	120		
18 × 35	100	–	100	100	150	150	150		
18 × 40	125	–	100	100	120	–	72		
20 × 20	125	–	125	125	200	–	–		
20 × 25	125	–	125	125	200	–	–		
20 × 30	100	–	100	100	120	–	–		
20 × 35	100	–	100	100	120	–	–		
20 × 40	100	–	100	100	120	–	–		
22 × 30	80	–	100	100	–	–	–		
22 × 35	80	–	100	100	–	–	–		
22 × 40	80	–	100	100	–	–	–		
25 × 40	40	–	100	–	–	–	–		
The last three digits of the complete ordering code state the lead configuration	000	Code	F (mm)	d (mm)	001	002	003	004	012
		007	2.5	4...6.3					
		008	5	6.3...12.5					
		009	7.5	16...18					



B43866

Up to 125 °C



Cautions and warnings

Personal safety

The electrolytes used by EPCOS have not only been optimized with a view to the intended application, but also with regard to health and environmental compatibility. They do not contain any solvents that are detrimental to health, e.g. dimethyl formamide (DMF) or dimethyl acetamide (DMAC).

Furthermore, part of the high-voltage electrolytes used by EPCOS are self-extinguishing. They contain flame-retarding substances which will quickly extinguish any flame that may have been ignited.

As far as possible, EPCOS does not use any dangerous chemicals or compounds to produce operating electrolytes. However, in exceptional cases, such materials must be used in order to achieve specific physical and electrical properties because no safe substitute materials are currently known. However, the amount of dangerous materials used in our products has been limited to an absolute minimum. Nevertheless, the following rules should be observed when handling Al electrolytic capacitors:

- Any escaping electrolyte should not come into contact with eyes or skin.
- If electrolyte does come into contact with the skin, wash the affected parts immediately with running water. If the eyes are affected, rinse them for 10 minutes with plenty of water. If symptoms persist, seek medical treatment.
- Avoid breathing in electrolyte vapor or mists. Workplaces and other affected areas should be well ventilated. Clothing that has been contaminated by electrolyte must be changed and rinsed in water.



B43866

Up to 125 °C

Product safety

The table below summarize the safety instructions that must be observed without fail. A detailed description can be found in the relevant sections of chapter "General technical information".

Topic	Safety information	Reference Chapter "General technical information"
Polarity	Make sure that polar capacitors are connected with the right polarity.	1 "Basic construction of aluminum electrolytic capacitors"
Reverse voltage	Voltages polarity classes should be prevented by connecting a diode.	3.1.6 "Reverse voltage"
Upper category temperature	Do not exceed the upper category temperatur.	7.2 "Maximum permissible operating temperature"
Maintenance	Make periodic inspections of the capacitors. Before the inspection, make sure that the power supply is turned off and carefully discharge the electricity of the capacitors. Do not apply any mechanical stress to the capacitor terminals.	10 "Maintenance"
Mounting position of screw terminal capacitors	Do not mount the capacitor with the terminals (safety vent) upside down.	11.1. "Mounting positions of capacitors with screw terminals"
Mounting of single-ended capacitors	The internal structure of single-ended capacitors might be damaged if excessive force is applied to the lead wires. Avoid any compressive, tensile or flexural stress. Do not move the capacitor after soldering to PC board. Do not pick up the PC board by the soldered capacitor. Do not insert the capacitor on the PC board with a hole space different to the lead space specified.	11.4 "Mounting considerations for single-ended capacitors"
Robustness of terminals	The following maximum tightening torques must not be exceeded when connecting screw terminals: M5: 2 Nm M6: 2.5 Nm	11.3 "Mounting torques"
Soldering	Do not exceed the specified time or temperature limits during soldering.	11.5 "Soldering"



B43866
Up to 125 °C



Topic	Safety information	Reference Chapter "General technical information"
Soldering, cleaning agents	Do not allow halogenated hydrocarbons to come into contact with aluminum electrolytic capacitors.	11.6 "Cleaning agents"
Passive flammability	Avoid external energy, such as fire or electricity.	8.1 "Passive flammability"
Active flammability	Avoid overload of the capacitors.	8.2 "Active flammability"
		Reference Chapter "Capacitors with screw terminals"
Breakdown strength of insulating sleeves	Do not damage the insulating sleeve, especially when ring clips are used for mounting.	"Screw terminals - accessories"



Important notes

The following applies to all products named in this publication:

1. Some parts of this publication contain **statements about the suitability of our products for certain areas of application**. These statements are based on our knowledge of typical requirements that are often placed on our products in the areas of application concerned. We nevertheless expressly point out **that such statements cannot be regarded as binding statements about the suitability of our products for a particular customer application**. As a rule, EPCOS is either unfamiliar with individual customer applications or less familiar with them than the customers themselves. For these reasons, it is always ultimately incumbent on the customer to check and decide whether an EPCOS product with the properties described in the product specification is suitable for use in a particular customer application.
2. We also point out that **in individual cases, a malfunction of passive electronic components or failure before the end of their usual service life cannot be completely ruled out in the current state of the art, even if they are operated as specified**. In customer applications requiring a very high level of operational safety and especially in customer applications in which the malfunction or failure of a passive electronic component could endanger human life or health (e.g. in accident prevention or life-saving systems), it must therefore be ensured by means of suitable design of the customer application or other action taken by the customer (e.g. installation of protective circuitry or redundancy) that no injury or damage is sustained by third parties in the event of malfunction or failure of a passive electronic component.
3. **The warnings, cautions and product-specific notes must be observed.**
4. In order to satisfy certain technical requirements, **some of the products described in this publication may contain substances subject to restrictions in certain jurisdictions (e.g. because they are classed as "hazardous")**. Useful information on this will be found in our Material Data Sheets on the Internet (www.epcos.com/material). Should you have any more detailed questions, please contact our sales offices.
5. We constantly strive to improve our products. Consequently, **the products described in this publication may change from time to time**. The same is true of the corresponding product specifications. Please check therefore to what extent product descriptions and specifications contained in this publication are still applicable before or when you place an order. We also **reserve the right to discontinue production and delivery of products**. Consequently, we cannot guarantee that all products named in this publication will always be available.
6. Unless otherwise agreed in individual contracts, **all orders are subject to the current version of the "General Terms of Delivery for Products and Services in the Electrical Industry" published by the German Electrical and Electronics Industry Association (ZVEI)**.
7. The trade names EPCOS, EPCOS-JONES, BAOKE, Alu-X, CeraDiode, CSSP, MLSC, MotorCap, PhaseCap, PhaseMod, SIFERRIT, SIFI, SIKOREL, SilverCap, SIMID, SIOV, SIP5D, SIP5K, UltraCap, WindCap are **trademarks registered or pending** in Europe and in other countries. Further information will be found on the Internet at www.epcos.com/trademarks.