

Silicon Schottky Diode Array

- General-purpose diode for high-speed switching
- Circuit protection
- Voltage clamping
- High-level detecting and mixing

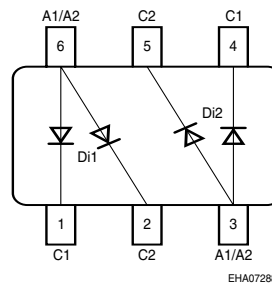
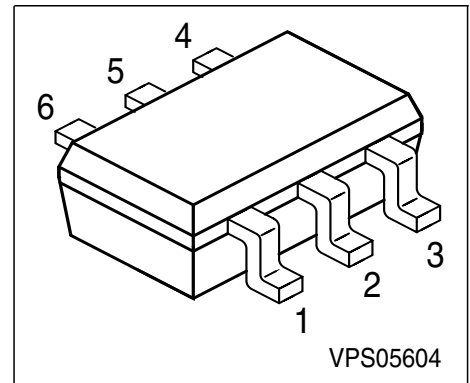

Type	Marking	Pin Configuration						Package
BAS 70-06S	76s	1=C1	2=C2	3=A1/A2	4=C1	5=C2	6=A1/A2	SOT-363

Maximum Ratings

Parameter	Symbol	Value	Unit
Diode reverse voltage	V_R	70	V
Forward current	I_F	70	mA
Surge forward current ($t < 10\text{ms}$)	I_{FSM}	100	
Total power dissipation, $T_S \leq 72\text{ }^\circ\text{C}$	P_{tot}	250	mW
Junction temperature	T_j	150	$^\circ\text{C}$
Operating temperature range	T_{op}	-55 ... 150	
Storage temperature	T_{stg}	-55 ... 150	

Thermal Resistance

Junction - ambient ¹⁾	R_{thJA}	≤ 545	K/W
Junction - soldering point	R_{thJS}	≤ 310	

1) Package mounted on epoxy pcb 40mm x 40mm x 1.5mm / 0.5cm² Cu

Electrical Characteristics at $T_A = 25^\circ\text{C}$, unless otherwise specified.

Parameter	Symbol	Values			Unit
		min.	typ.	max.	
DC characteristics					
Breakdown voltage $I_{(BR)} = 10 \mu\text{A}$	$V_{(BR)}$	70	-	-	V
Reverse current $V_R = 50 \text{ V}$ $V_R = 70 \text{ V}$	I_R	- -	- -	0.1 10	μA
Forward voltage $I_F = 1 \text{ mA}$ $I_F = 10 \text{ mA}$ $I_F = 15 \text{ mA}$	V_F	300 600 750	375 705 880	410 750 1000	mV
AC characteristics					
Diode capacitance $V_R = 0 \text{ V}, f = 1 \text{ MHz}$	C_T	-	1.6	2	pF
Charge carrier life time $I_F = 25 \text{ mA}$	τ	-	-	100	ps
Differential forward resistance $I_F = 10 \text{ mA}, f = 100 \text{ MHz}$	R_F	-	30	-	Ω

Forward current $I_F = f(T_A^*; T_S)$

* Package mounted on epoxy

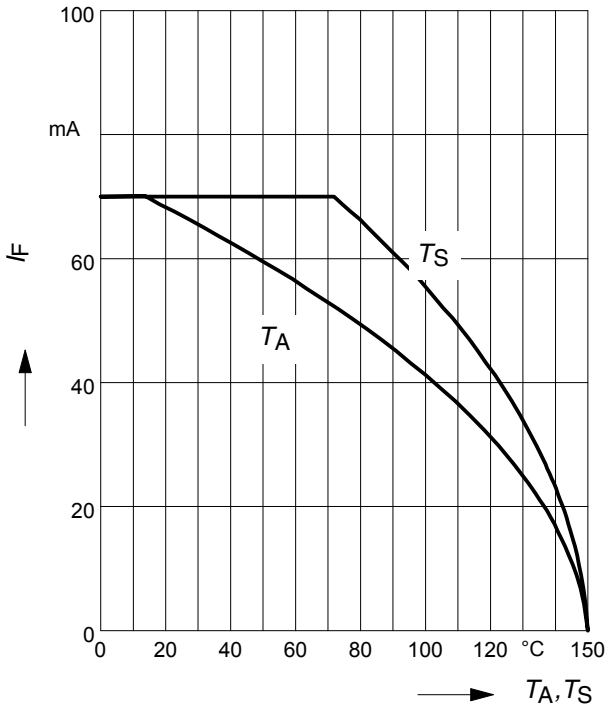

Permissible Pulse Load $R_{thJS} = f(t_p)$

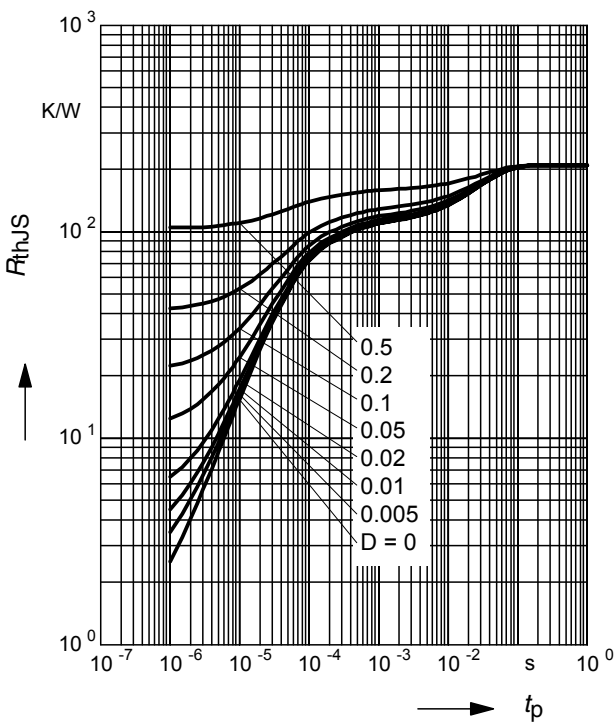

Permissible Pulse Load

$I_{Fmax} / I_{FDC} = f(t_p)$

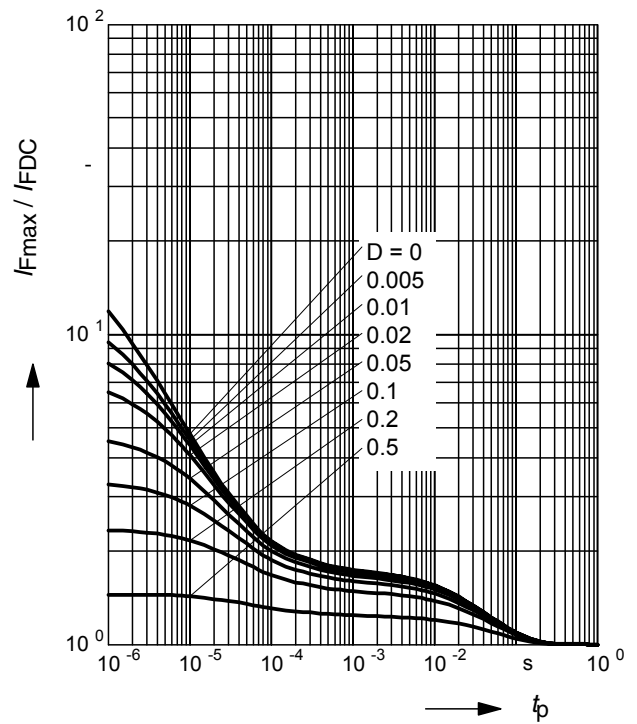

Forward current $I_F = f(V_F)$

$T_A =$ Parameter

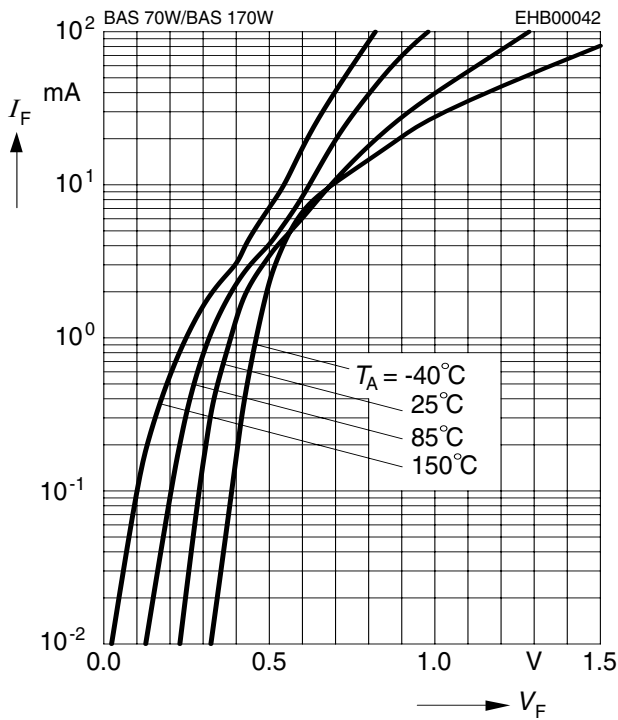

Reverse current $I_R = f(V_R)$

$T_A =$ Parameter

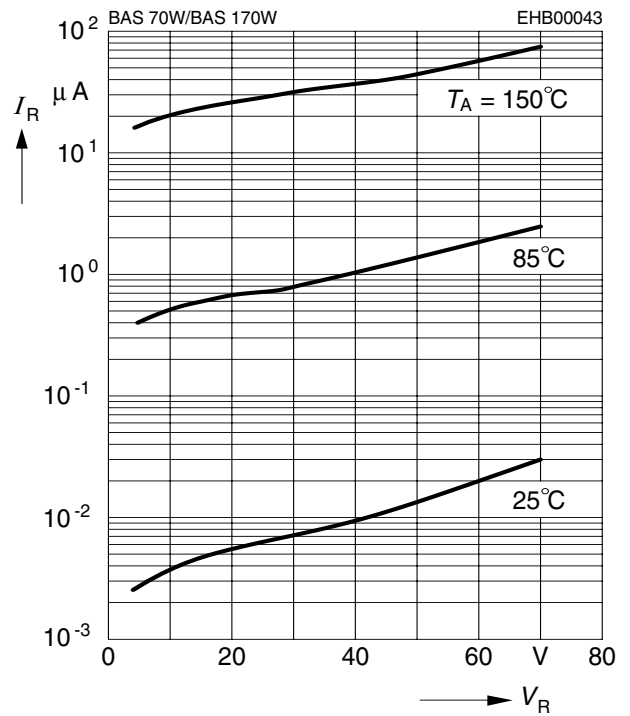

Diode capacitance $C_T = f(V_R)$

$f = 1\text{MHz}$

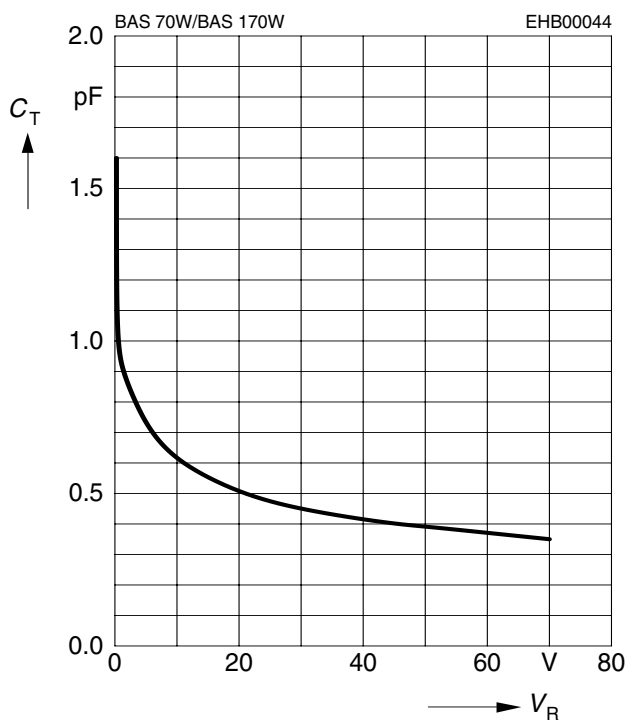

Differential forward resistance $r_f = f(I_F)$

$f = 10\text{kHz}$

