

Cree® PLCC6 SMD LED

CLP6S-WKW/MKW

Data Sheet

These SMD LEDs are packaged in an industry-standard PLCC6 package. These high-reliability and high-brightness LEDs are designed to work in a wide range of environmental conditions and are ideally suited for use in illumination applications.

Their wide viewing angle makes these LEDs ideally suited for channel-letter and general-backlighting and illumination applications. The flat-top emitting surface makes it easy for these LEDs to mate with light pipes.

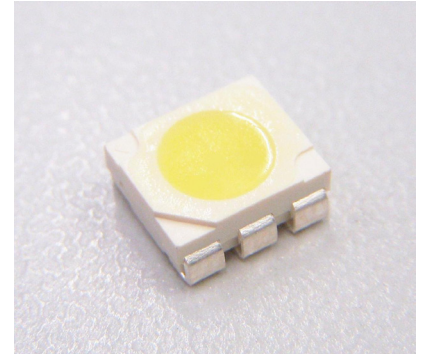

FEATURES

- Size (mm): 6.0 x 5.0
- Color Temperatures (K):
 - » CLP6S-WKW: Cool White: Min. (4600) / Typical (6800)
 - » CLP6S-MKW: Warm White: Min. (2500) / Typical (3200)
- CRI
 - » Typical CRI for Cool White (4600 – 15000K) is 72
 - » Typical CRI for Warm White (2500 – 4600K) is 80
- Viewing Angle: 120 degrees
- Luminous Intensity (mcd):
 - » Cool White (3550 - 7100)
 - » Warm White (2800 - 7100)
- Lead-Free
- RoHS-Compliant

APPLICATIONS

- Light Strip
- Channel Letter
- Backlight



Absolute Maximum Ratings ($T_A = 25^\circ\text{C}$)

Items	Symbol	Absolute Maximum Rating	Unit
Forward Current	I_F	3 x 50	mA
Peak Forward Current ^{Note}	I_{FP}	3 x 100	mA
Reverse Voltage	V_R	5	V
Power Dissipation	P_D	3 x 250	mW
Operation Temperature	T_{opr}	-40 ~ +100	$^\circ\text{C}$
Storage Temperature	T_{stg}	-40 ~ +100	$^\circ\text{C}$
Junction Temperature	T_J	110	$^\circ\text{C}$
Junction/Ambient	R_{THJA}	3 x 300	$^\circ\text{C}/\text{W}$
Junction/Solder Point	R_{THJS}	3 x 160	$^\circ\text{C}/\text{W}$

Note: Pulse width ≤ 0.1 msec, duty $\leq 1/10$.

Typical Electrical & Optical Characteristics ($T_A = 25^\circ\text{C}$)

Characteristics	Color	Symbol	Condition	Unit	Minimum	Typical	Maximum
Forward Voltage	Cool/Warm	V_F	$I_F = 50$ mA	V		4.0	5.0
Reverse Current	Cool/Warm	I_R	$V_R = 5$ V	μA			10
Luminous Flux	Cool/Warm	Φ_V	$I_F = 3 \times 50$ mA	mlm		9000	
Luminous Intensity	Cool	I_V	$I_F = 3 \times 50$ mA	mcd	3550	4000	
	Warm	I_V	$I_F = 3 \times 50$ mA	mcd	2800	3800	
Chromaticity Coordinates	Cool	x	$I_F = 3 \times 50$ mA			0.3100	
	Cool	y	$I_F = 3 \times 50$ mA			0.3200	
	Warm	x	$I_F = 3 \times 50$ mA			0.4260	
	Warm	y	$I_F = 3 \times 50$ mA			0.4070	
50% Power Angle	Cool/Warm	$2\theta_{1/2}$	$I_F = 3 \times 50$ mA	deg		120	



Intensity Bin Limit ($I_F = 3 \times 50 \text{ mA}$)

Cool White

Bin Code	Min. (mcd)	Max. (mcd)
Yb	3550	4500
Z0	4500	5600
A0	5600	7100

Warm White

Bin Code	Min. (lm)	Max. (lm)
Ya	2800	3550
Yb	3550	4500
Z0	4500	5600
A0	5600	7100

Tolerance of measurement of luminous Intensity is $\pm 10\%$.

VF Bin Limit ($I_F = 50 \text{ mA}$)

Cool White

Bin Code	Min. (V)	Max. (V)
29	3.2	3.4
2a	3.4	3.6
2b	3.6	3.8
2c	3.8	4.0
2d	4.0	4.2
2e	4.2	4.4
2f	4.4	4.6
2g	4.6	4.8
2h	4.8	5.0

Warm White

Bin Code	Min. (V)	Max. (V)
29	3.2	3.4
2a	3.4	3.6
2b	3.6	3.8
2c	3.8	4.0
2d	4.0	4.2
2e	4.2	4.4
2f	4.4	4.6
2g	4.6	4.8
2h	4.8	5.0

Tolerance of measurement of VF is $\pm 0.05 \text{ V}$.

Color Bin Limit ($I_F = 3 \times 50 \text{ mA}$)

Cool White

Bin Code	Sub-bin	x	y
W1	Wa	0.2545	0.2480
		0.2633	0.2410
		0.2545	0.2245
		0.2450	0.2290
	Wb	0.2633	0.2410
		0.2720	0.2340
		0.2640	0.2200
		0.2545	0.2245
	Wc	0.2545	0.2480
		0.2640	0.2670
		0.2720	0.2575
		0.2633	0.2410
	Wd	0.2633	0.2410
		0.2720	0.2575
		0.2800	0.2480
		0.2720	0.2340

Bin Code	Sub-bin	x	y
W2	We	0.2640	0.2670
		0.2735	0.2860
		0.2808	0.2740
		0.2720	0.2575
		0.2720	0.2575
	Wf	0.2808	0.2740
		0.2880	0.2620
		0.2800	0.2480
		0.2735	0.2860
	Wg	0.2830	0.3050
		0.2895	0.2905
		0.2808	0.2740
		0.2808	0.2740
	Wh	0.2895	0.2905
		0.2960	0.2760
		0.2880	0.2620
0.2808		0.2740	

Bin Code	Sub-bin	x	y
W3	Wj	0.2830	0.3050
		0.2950	0.3210
		0.2998	0.3028
		0.2895	0.2905
		0.2895	0.2905
	Wk	0.2998	0.3028
		0.3045	0.2865
		0.2960	0.2760
		0.2950	0.3210
	Wm	0.3070	0.3370
		0.3100	0.3150
		0.2998	0.3028
		0.2998	0.3028
	Wn	0.3100	0.3150
		0.3130	0.2970
		0.3045	0.2865
0.2808		0.2740	



Color Bin Limit ($I_F = 3 \times 50 \text{ mA}$)

Cool White

Bin Code	Sub-bin	x	y
W4	Wp	0.3070	0.3370
		0.3185	0.3485
		0.3200	0.3270
		0.3100	0.3150
	Wq	0.3100	0.3150
		0.3200	0.3270
		0.3215	0.3075
		0.3130	0.2970
	Wr	0.3185	0.3485
		0.3300	0.3600
		0.3300	0.3390
		0.3200	0.3270
	Ws	0.3200	0.3270
		0.3300	0.3390
		0.3300	0.3180
		0.3215	0.3075

Bin Code	Sub-bin	x	y
W5	Wt	0.3300	0.3600
		0.3455	0.3725
		0.3443	0.3535
		0.3300	0.3390
	Wu	0.3300	0.3390
		0.3443	0.3535
		0.3430	0.3345
		0.3300	0.3180
	Wv	0.3455	0.3725
		0.3610	0.3850
		0.3585	0.3680
		0.3443	0.3535
	Ww	0.3443	0.3535
		0.3585	0.3680
		0.3560	0.3510
		0.3430	0.3345

Tolerance of measurement of the color coordinates is ± 0.01 .

Warm White

Bin Code	Sub-bin	x	y
M1	Ma	0.3610	0.3900
		0.3576	0.3651
		0.3751	0.3783
		0.3820	0.4075
	Mb	0.3576	0.3651
		0.3541	0.3401
		0.3682	0.3491
		0.3749	0.3781
	Mc	0.3820	0.4075
		0.3751	0.3783
		0.3926	0.3915
		0.4030	0.4250
	Md	0.3751	0.3783
		0.3682	0.3491
		0.3822	0.3580
		0.3926	0.3915

Bin Code	Sub-bin	x	y
M2	Me	0.4030	0.4250
		0.3926	0.3915
		0.4118	0.4021
		0.4260	0.4390
	Mf	0.3926	0.3915
		0.3822	0.3580
		0.3976	0.3653
		0.4118	0.4021
	Mg	0.4260	0.4390
		0.4118	0.4021
		0.4310	0.4128
		0.4490	0.4530
	Mh	0.4118	0.4021
		0.3976	0.3653
		0.4129	0.3725
		0.4310	0.4128

Bin Code	Sub-bin	x	y
M3	Mj	0.4490	0.4530
		0.4310	0.4128
		0.4572	0.4203
		0.4785	0.4625
	Mk	0.4310	0.4128
		0.4129	0.3726
		0.4359	0.3782
		0.4572	0.4203
	Mm	0.4785	0.4625
		0.4572	0.4203
		0.4834	0.4279
		0.5080	0.4720
	Mn	0.4572	0.4203
		0.4359	0.3782
		0.4588	0.3838
		0.4834	0.4279

Tolerance of measurement of the color coordinates is ± 0.01 .

CIE Chromaticity Diagram

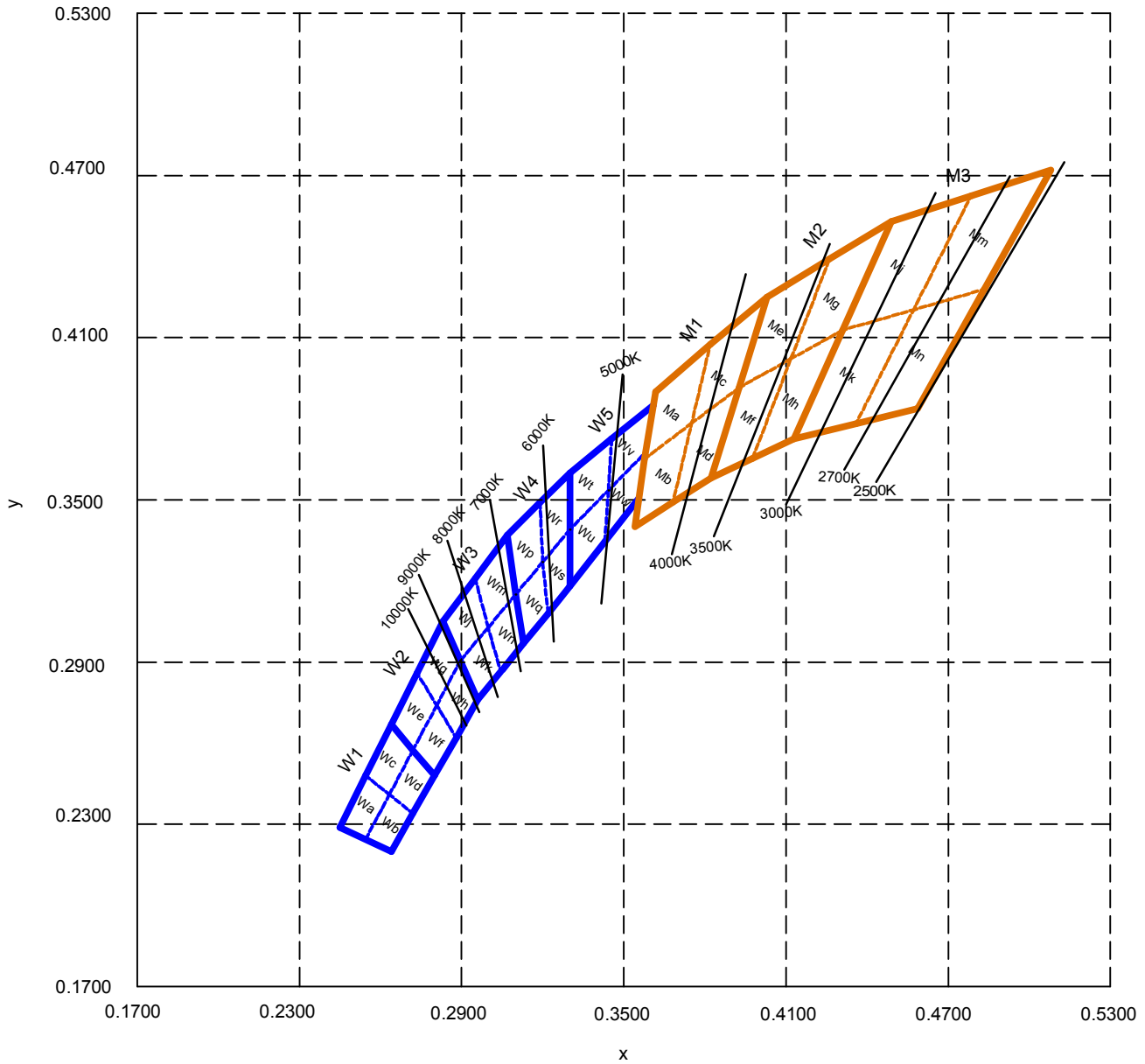



Order Code Table*

Cool White

Color	Kit Number	Viewing Angle	Luminous Intensity (mcd)		Color Bin Code
			Min.	Max.	
Cool White	CLP6S-WKW-CYbA0153	120	3550	7100	W1,W2,W3,W4,W5

Warm White

Color	Kit Number	Viewing Angle	Luminous Intensity (mcd)		Color Bin Code
			Min.	Max.	
Warm White	CLP6S-MKW-CYaA0133	120	2800	7100	M1,M2,M3

Notes:

1. The above kit numbers represent order codes that include multiple intensity-bin and color-bin codes. Only one intensity-bin code and one color-bin code will be shipped on each reel. Single intensity-bin codes and single color-bin codes will not be orderable.
2. Please refer to the "Cree LED Lamp Reliability Test Standards" document for reliability test conditions.
3. Please refer to the "Cree LED Lamp Soldering & Handling" document for information about how to use this LED product safely.

Graphs

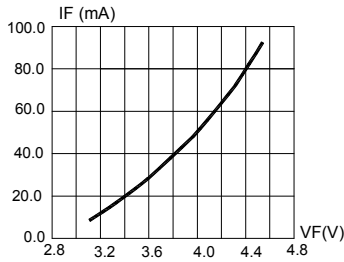

FIG.1 FORWARD CURRENT VS. FORWARD VOLTAGE.

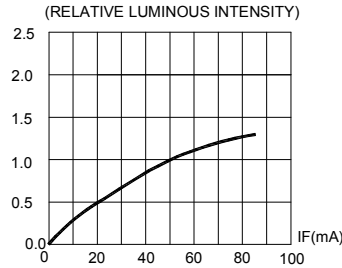

FIG.2 RELATIVE LUMINOUS INTENSITY VS. FORWARD CURRENT

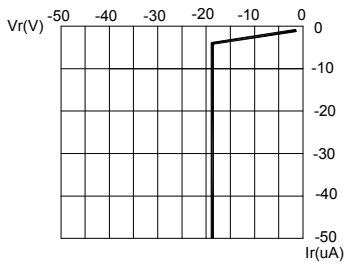

FIG.3 REVERSE CURRENT VS. REVERSE VOLTAGE.

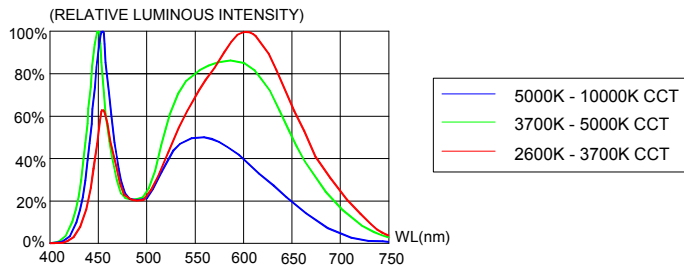

FIG.4 RELATIVE LUMINOUS INTENSITY VS. WAVELENGTH.

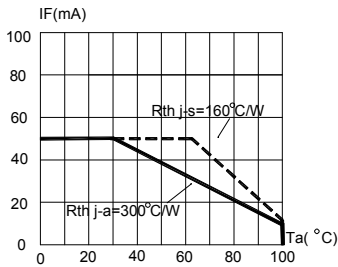

FIG.5 MAXIMUM FORWARD DC CURRENT VS AMBIENT TEMPERATURE (Tjmax=110°C)

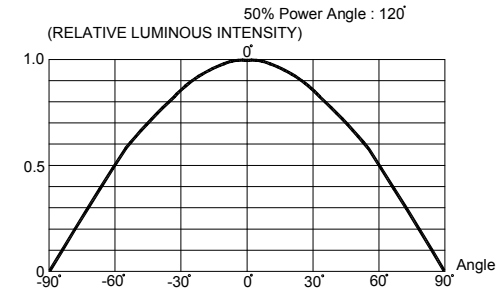
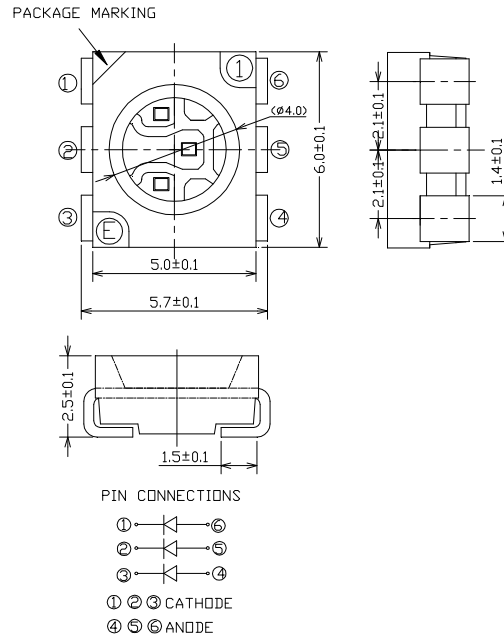

FIG.6 FAR FIELD PATTERN

The above data are collected from statistical figures that do not necessarily correspond to the actual parameters of each single LED. Hence, these data will be changed without further notice.

Mechanical Dimensions

All dimensions are in mm.



Notes

RoHS Compliance

The levels of environmentally sensitive, persistent biologically toxic (PBT), persistent organic pollutants (POP), or otherwise restricted materials in this product are below the maximum concentration values (also referred to as the threshold limits) permitted for such substances, or are used in an exempted application, in accordance with EU Directive 2002/95/EC on the restriction of the use of certain hazardous substances in electrical and electronic equipment (RoHS), as amended through April 21, 2006.

Vision Advisory Claim

Users should be cautioned not to stare at the light of this LED product. The bright light can damage the eye.



Kit Number System

Cree LED lamps are tested and sorted into performance bins. A bin is specified by ranges of color, forward voltage, and brightness. Sorted LEDs are packaged for shipping in various convenient options. Please refer to the "Cree LED Lamp Packaging Standard" document for more information about shipping and packaging options.

Cree LEDs are sold by order codes in combinations of bins called kits. Order codes are configured in the following manner:

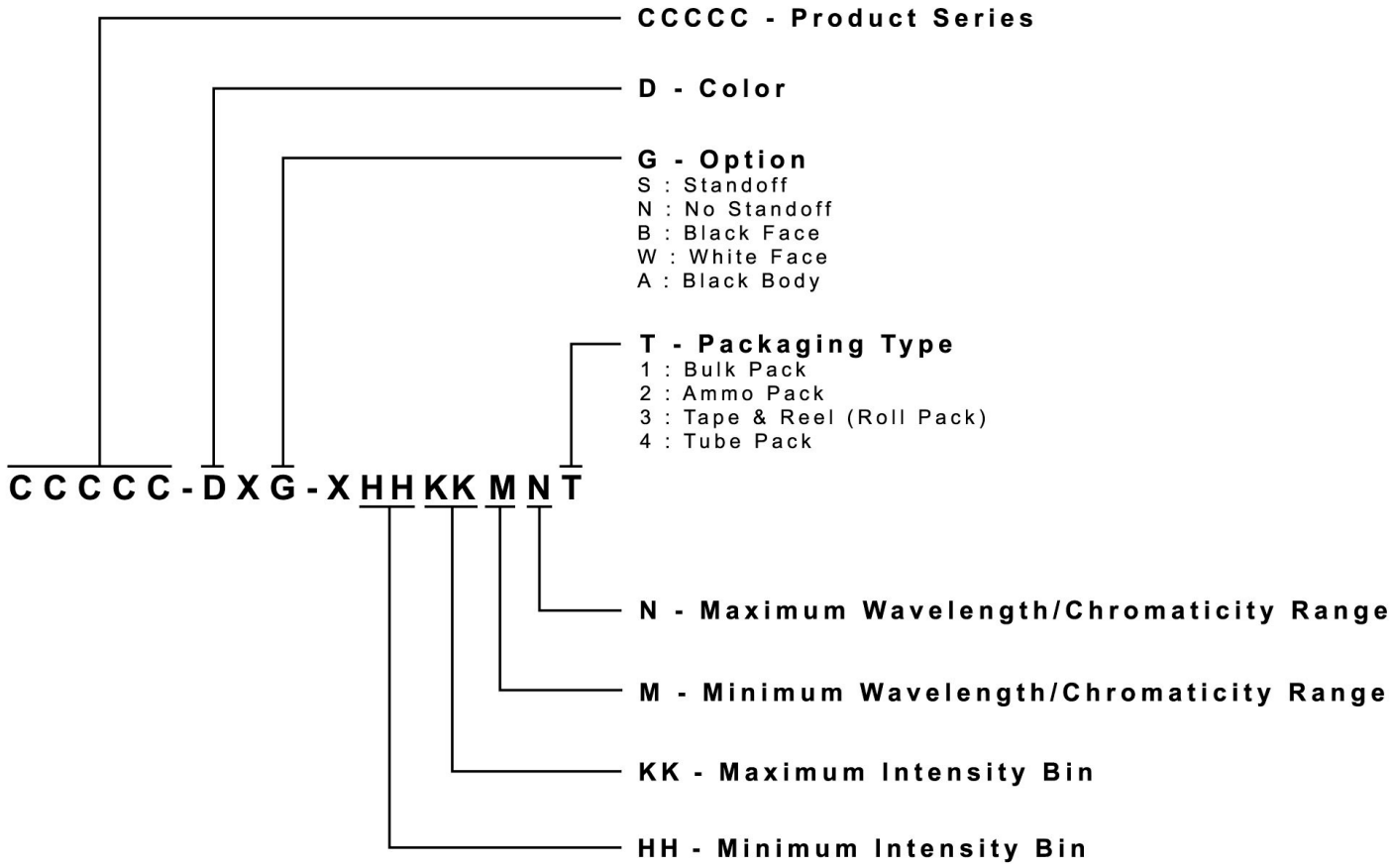

Packaging

- The boxes are not water-resistant, and they must be kept away from water and moisture.
- The LEDs are packed in cardboard boxes after packaging in normal or anti-electrostatic bags.
- Cardboard boxes will be used to protect the LEDs from mechanical shocks during transportation.
- The reel pack is applied in SMD LED.
- Max 900 pcs per reel.

