

FEATURES

- Wide Input Range...up to 30 V
- Rated Output Current of 100 mA
- Low Dropout...380 mV (Typ) at 100 mA
- Low Quiescent Current...75 μ A (Typ)
- Tight Line Regulation...0.03% (Typ)
- Tight Load Regulation...0.04% (Typ)
- High V_O Accuracy
 - 1.4% at 25°C
 - 2% Over Temperature
- Can Be Used as a Regulator or Reference
- Stable With Low ESR (>12 m Ω) Capacitors
- Current- and Thermal-Limiting Features
- LP2950 Only (3-Pin Package)
 - Fixed-Output Voltages of 5 V, 3.3 V, and 3 V
- LP2951 Only (8-Pin Package)
 - Fixed- or Adjustable-Output Voltages: 5 V/ADJ, 3.3 V/ADJ, and 3 V/ADJ
 - Low-Voltage Error Signal on Falling Output
 - Shutdown Capability
 - Remote Sense Capability for Optimal Output Regulation and Accuracy

LP2950...LP (TO-226/TO-92 PACKAGE)
(BOTTOM VIEW)

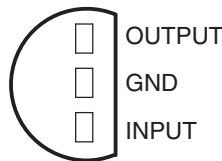

LP2951...D (SOIC) PACKAGE
(TOP VIEW)

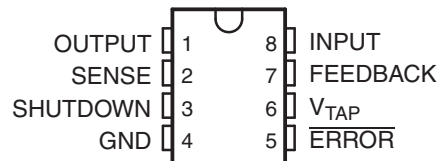

DESCRIPTION/ORDERING INFORMATION

The LP2950 and LP2951 devices are bipolar, low-dropout voltage regulators that can accommodate a wide input supply-voltage range of up to 30 V. The easy-to-use, 3-pin LP2950 is available in fixed-output voltages of 5 V, 3.3 V, and 3 V. However, the 8-pin LP2951 is able to output either a fixed or adjustable output from the same device. By tying the OUTPUT and SENSE pins together, and the FEEDBACK and V_{TAP} pins together, the LP2951 outputs a fixed 5 V, 3.3 V, or 3 V (depending on the version). Alternatively, by leaving the SENSE and V_{TAP} pins open and connecting FEEDBACK to an external resistor divider, the output can be set to any value between 1.235 V to 30 V.

The 8-pin LP2951 also offers additional functionality that makes it particularly suitable for battery-powered applications. For example, a logic-compatible shutdown feature allows the regulator to be put in standby mode for power savings. In addition, there is a built-in supervisor reset function in which the $\overline{\text{ERROR}}$ output goes low when V_{OUT} drops by 6% of its nominal value for whatever reasons – due to a drop in V_{IN} , current limiting, or thermal shutdown.

The LP2950 and LP2951 are designed to minimize all error contributions to the output voltage. With a tight output tolerance (0.5% at 25°C), a very low output voltage temperature coefficient (20 ppm typical), extremely good line and load regulation (0.3% and 0.4% typical), and remote sensing capability, the parts can be used as either low-power voltage references or 100-mA regulators.



Please be aware that an important notice concerning availability, standard warranty, and use in critical applications of Texas Instruments semiconductor products and disclaimers thereto appears at the end of this data sheet.

LP2950, LP2951 ADJUSTABLE MICROPOWER VOLTAGE REGULATORS WITH SHUTDOWN

SLVS582D–APRIL 2006–REVISED MARCH 2007

ORDERING INFORMATION⁽¹⁾

| T _A | V _{OUT} (NOM) | PACKAGE ⁽²⁾ | | ORDERABLE PART NUMBER | TOP-SIDE MARKING |
|----------------|---------------------------|------------------------|--------------|--------------------------|------------------|
| –40°C to 125°C | 3 V | TO-226/TO-92 – LP | Bulk of 1000 | LP2950-30LP | KY5030 |
| | | | Reel of 2000 | LP2950-30LPR | |
| | | SOIC – D | Tube of 75 | LP2951-30D | KY5130 |
| | | | Reel of 2500 | LP2951-30DR | |
| | 3.3 V | TO-226/TO-92 – LP | Bulk of 1000 | LP2950-33LP | KY5033 |
| | | | Reel of 2000 | LP2950-33LPR | |
| | | SOIC – D | Tube of 75 | LP2951-33D | KY5133 |
| | | | Reel of 2500 | LP2951-33DR | |
| | 5 V | TO-226/TO-92 – LP | Bulk of 1000 | LP2950-50LP | PREVIEW |
| | | | Reel of 2000 | LP2950-50LPR | KY5050 |
| | | SOIC – D | Tube of 75 | LP2951-50D | KY5150 |
| | | | Reel of 2500 | LP2951-50DR | |
| ADJ | SOIC-D | Tube of 75 | LP2951D | KY5150 | |
| | | Reel of 2500 | LP2951DR | | |

- (1) For the most current package and ordering information, see the Package Option Addendum at the end of this document, or see the TI website at www.ti.com.
- (2) Package drawings, standard packing quantities, thermal data, symbolization, and PCB design guidelines are available at www.ti.com/sc/package.

LP2950 FUNCTIONAL BLOCK DIAGRAM

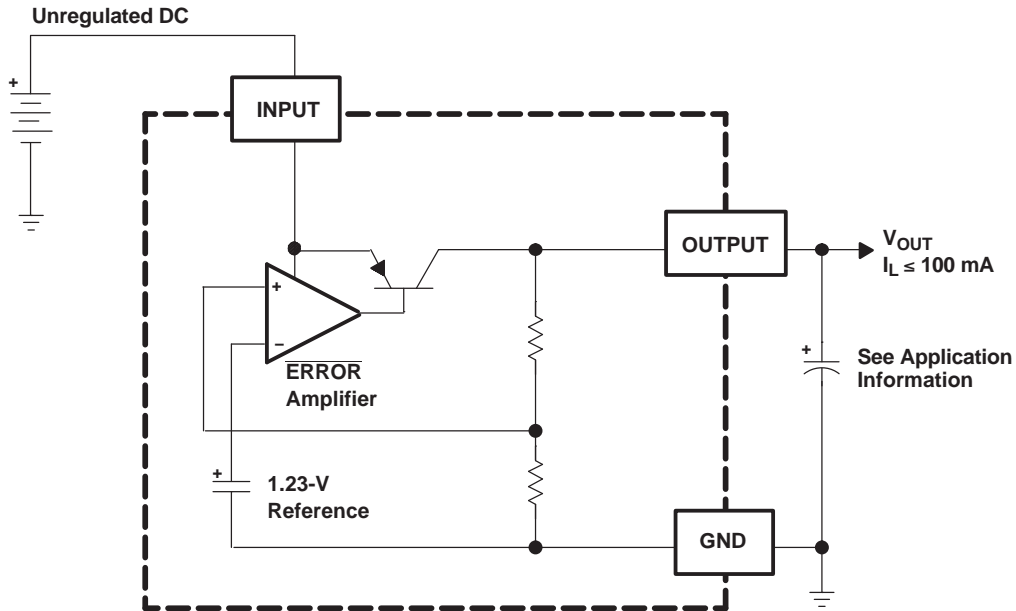

LP2951 FUNCTIONAL BLOCK DIAGRAM

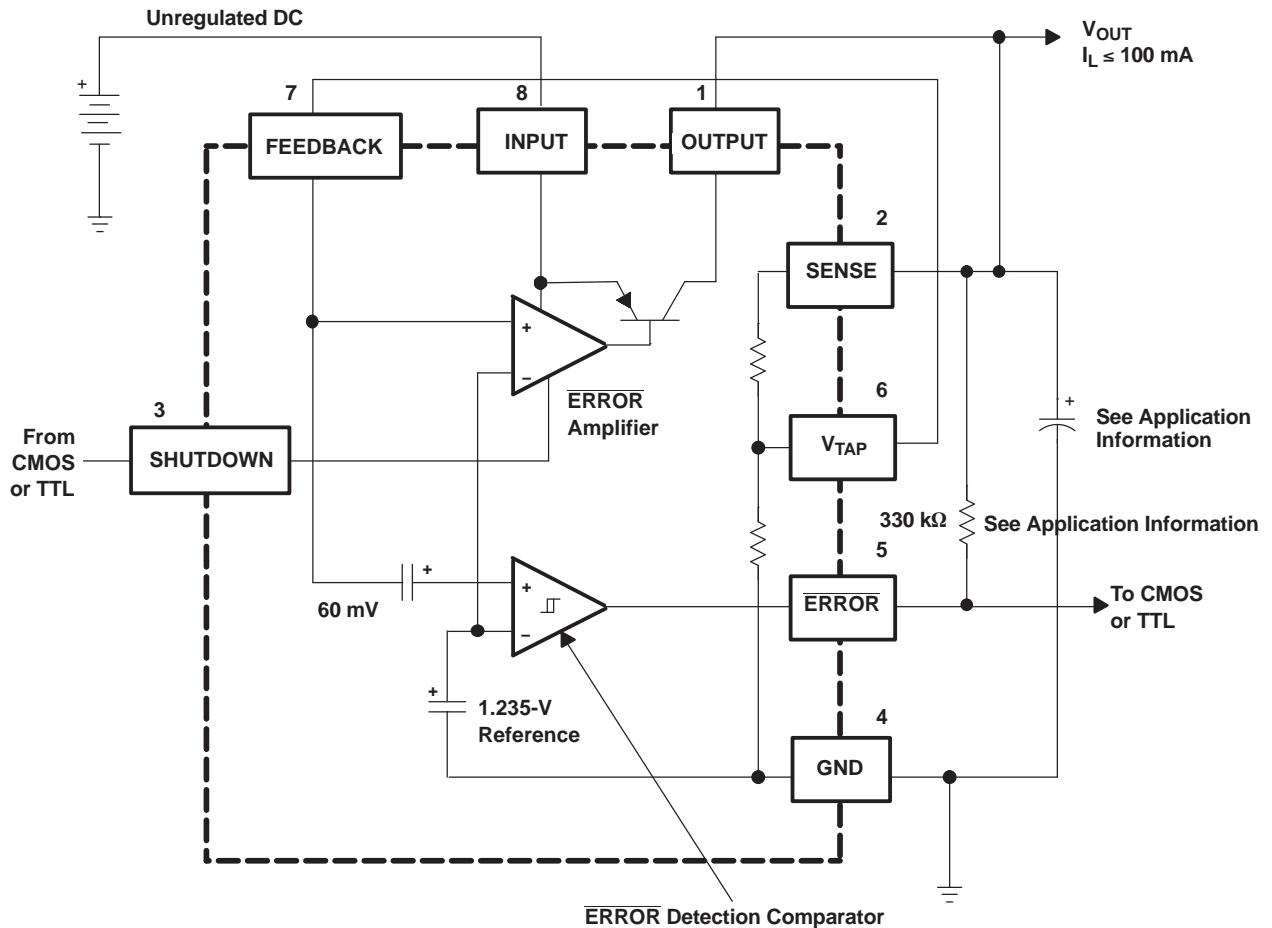

LP2950, LP2951 ADJUSTABLE MICROPOWER VOLTAGE REGULATORS WITH SHUTDOWN

SLVS582D–APRIL 2006–REVISED MARCH 2007

Absolute Maximum Ratings⁽¹⁾

over operating free-air temperature range (unless otherwise noted)

| | | MIN | MAX | UNIT |
|-------------------|--|------------|-----|------|
| V _{IN} | Continuous input voltage range | –0.3 | 30 | V |
| V _{SHDN} | SHUTDOWN input voltage range | –1.5 | 30 | V |
| | ERROR comparator output voltage range ⁽²⁾ | –1.5 | 30 | V |
| V _{FDBK} | FEEDBACK input voltage range ⁽²⁾⁽³⁾ | –1.5 | 30 | V |
| θ _{JA} | Package thermal impedance ⁽⁴⁾⁽⁵⁾ | D package | | °C/W |
| | | LP package | | |
| T _J | Operating virtual junction temperature | | 150 | °C |
| T _{stg} | Storage temperature range | –65 | 150 | °C |

- (1) Stresses beyond those listed under "absolute maximum ratings" may cause permanent damage to the device. These are stress ratings only, and functional operation of the device at these or any other conditions beyond those indicated under "recommended operating conditions" is not implied. Exposure to absolute-maximum-rated conditions for extended periods may affect device reliability.
- (2) May exceed input supply voltage
- (3) If load is returned to a negative power supply, the output must be diode clamped to GND.
- (4) Maximum power dissipation is a function of T_{J(max)}, θ_{JA}, and T_A. The maximum allowable power dissipation at any allowable ambient temperature is P_D = (T_{J(max)} – T_A)/θ_{JA}. Operating at the absolute maximum T_J of 150°C can affect reliability.
- (5) The package thermal impedance is calculated in accordance with JESD 51-7.

Recommended Operating Conditions

| | | MIN | MAX | UNIT |
|-----------------|--|----------------|-----|------|
| V _{IN} | Supply input voltage | ⁽¹⁾ | 30 | V |
| T _J | Operating virtual junction temperature | –40 | 125 | °C |

- (1) Minimum V_{IN} is the greater of:
 - a. 2 V (25°C), 2.3 V (over temperature), or
 - b. V_{OUT(MAX)} + Dropout (Max) at rated I_L

Electrical Characteristics

$V_{IN} = V_{OUT}$ (nominal) + 1 V, $I_L = 100 \mu\text{A}$, $C_L = 1 \mu\text{F}$ (5-V versions) or $C_L = 2.2 \mu\text{F}$ (3-V and 3.3-V versions),
 8-pin version: FEEDBACK tied to V_{TAP} , OUTPUT tied to SENSE, $V_{SHUTDOWN} \leq 0.7 \text{ V}$

| PARAMETER | | TEST CONDITIONS | T_J | MIN | TYP | MAX | UNIT |
|---|--|---|----------------|-------|-------|-------|---------------|
| 3-V VERSION (LP295x-30) | | | | | | | |
| V_{OUT} | Output voltage | $I_L = 100 \mu\text{A}$ | 25°C | 2.970 | 3 | 3.030 | V |
| | | | –40°C to 125°C | 2.940 | 3 | 3.060 | |
| 3.3-V VERSION (LP295x-33) | | | | | | | |
| V_{OUT} | Output voltage | $I_L = 100 \mu\text{A}$ | 25°C | 3.267 | 3.3 | 3.333 | V |
| | | | –40°C to 125°C | 3.234 | 3.3 | 3.366 | |
| 5-V VERSION (LP295x-50) | | | | | | | |
| V_{OUT} | Output voltage | $I_L = 100 \mu\text{A}$ | 25°C | 4.950 | 5 | 5.050 | V |
| | | | –40°C to 125°C | 4.900 | 5 | 5.100 | |
| ALL VOLTAGE OPTIONS | | | | | | | |
| | Output voltage temperature coefficient ⁽¹⁾ | $I_L = 100 \mu\text{A}$ | –40°C to 125°C | | 20 | 100 | ppm/°C |
| | Line regulation ⁽²⁾ | $V_{IN} = [V_{OUT(NOM)} + 1 \text{ V}] \text{ to } 30 \text{ V}$ | 25°C | | 0.03 | 0.2 | %V |
| | | | –40°C to 125°C | | | | |
| | Load regulation ⁽²⁾ | $I_L = 100 \mu\text{A} \text{ to } 100 \text{ mA}$ | 25°C | | 0.04 | 0.2 | % |
| | | | –40°C to 125°C | | | | |
| $V_{IN} - V_{OUT}$ | Dropout voltage ⁽³⁾ | $I_L = 100 \mu\text{A}$ | 25°C | | 50 | 80 | mV |
| | | | –40°C to 125°C | | | | |
| | | $I_L = 100 \text{ mA}$ | 25°C | | 380 | 450 | |
| | | | –40°C to 125°C | | | | |
| I_{GND} | GND current | $I_L = 100 \mu\text{A}$ | 25°C | | 75 | 120 | μA |
| | | | –40°C to 125°C | | | | |
| | | $I_L = 100 \text{ mA}$ | 25°C | | 8 | 12 | mA |
| | | | –40°C to 125°C | | | | |
| | Dropout ground current | $V_{IN} = V_{OUT(NOM)} - 0.5 \text{ V}$, $I_L = 100 \mu\text{A}$ | 25°C | | 110 | 170 | μA |
| | | | –40°C to 125°C | | | | |
| | Current limit | $V_{OUT} = 0 \text{ V}$ | 25°C | | 160 | 200 | mA |
| | | | –40°C to 125°C | | | | |
| | Thermal regulation ⁽⁴⁾ | $I_L = 100 \mu\text{A}$ | 25°C | | 0.05 | 0.2 | %/W |
| | Output noise (RMS), 10 Hz to 100 kHz | $C_L = 1 \mu\text{F}$ (5 V only) | 25°C | | 430 | | μV |
| | | $C_L = 200 \mu\text{F}$ | | | 160 | | |
| | | LP2951-50: $C_L = 3.3 \mu\text{F}$, $C_{Bypass} = 0.01 \mu\text{F}$ between pins 1 and 7 | | | 100 | | |
| (LP2951-xx) 8-PIN VERSION ONLY ADJ | | | | | | | |
| | Reference voltage | $V_{OUT} = V_{REF} \text{ to } (V_{IN} - 1 \text{ V})$, $V_{IN} = 2.3 \text{ V to } 30 \text{ V}$, $I_L = 100 \mu\text{A to } 100 \text{ mA}$ | 25°C | 1.218 | 1.235 | 1.252 | V |
| | | | –40°C to 125°C | 1.212 | | 1.257 | |
| | | | –40°C to 125°C | 1.200 | | 1.272 | |
| | Reference voltage temperature coefficient ⁽¹⁾ | | 25°C | | 20 | | ppm/°C |

- (1) Output or reference voltage temperature coefficient is defined as the worst-case voltage change divided by the total temperature range.
- (2) Regulation is measured at constant junction temperature, using pulse testing with a low duty cycle. Changes in output voltage due to heating effects are covered under the specification for thermal regulation.
- (3) Dropout voltage is defined as the input-to-output differential at which the output voltage drops 100 mV, below the value measured at 1-V differential. The minimum input supply voltage of 2 V (2.3 V over temperature) must be observed.
- (4) Thermal regulation is defined as the change in output voltage at a time (T) after a change in power dissipation is applied, excluding load or line regulation effects. Specifications are for a 50-mA load pulse at $V_{IN} = 30 \text{ V}$, $V_{OUT} = 5 \text{ V}$ (1.25-W pulse) for $t = 10 \text{ ms}$.

LP2950, LP2951 ADJUSTABLE MICROPOWER VOLTAGE REGULATORS WITH SHUTDOWN

SLVS582D–APRIL 2006–REVISED MARCH 2007

Electrical Characteristics (continued)

$V_{IN} = V_{OUT} \text{ (nominal)} + 1 \text{ V}$, $I_L = 100 \mu\text{A}$, $C_L = 1 \mu\text{F}$ (5-V versions) or $C_L = 2.2 \mu\text{F}$ (3-V and 3.3-V versions),
8-pin version: FEEDBACK tied to V_{TAP} , OUTPUT tied to SENSE, $V_{SHUTDOWN} \leq 0.7 \text{ V}$

| PARAMETER | TEST CONDITIONS | T_J | MIN | TYP | MAX | UNIT |
|--|---|----------------|-----|------|-----|---------------|
| FEEDBACK bias current | | 25°C | | 20 | 40 | nA |
| | | –40°C to 125°C | | | 60 | |
| FEEDBACK bias current temperature coefficient | | 25°C | | 0.1 | | nA/°C |
| ERROR COMPARATOR | | | | | | |
| Output leakage current | $V_{OUT} = 30 \text{ V}$ | 25°C | | 0.01 | 1 | μA |
| | | –40°C to 125°C | | | 2 | |
| Output low voltage | $V_{IN} = V_{OUT(NOM)} - 0.5 \text{ V}$, $I_{OL} = 400 \mu\text{A}$ | 25°C | | 150 | 250 | mV |
| | | –40°C to 125°C | | | 400 | |
| Upper threshold voltage (ERROR output high) ⁽⁵⁾ | | 25°C | 40 | 60 | | mV |
| | | –40°C to 125°C | 25 | | | |
| Lower threshold voltage (ERROR output low) ⁽⁵⁾ | | 25°C | | 75 | 95 | mV |
| | | –40°C to 125°C | | | 140 | |
| Hysteresis ⁽⁶⁾ | | 25°C | | 15 | | mV |
| SHUTDOWN INPUT | | | | | | |
| Input logic voltage | Low (regulator ON) | –40°C to 125°C | | | 0.7 | V |
| | High (regulator OFF) | | | 2 | | |
| SHUTDOWN input current | $V_{TAP} = 2.4 \text{ V}$ | 25°C | | 30 | 50 | μA |
| | | –40°C to 125°C | | | 100 | |
| | $V_{TAP} = 30 \text{ V}$ | 25°C | | 450 | 600 | |
| | | –40°C to 125°C | | | 750 | |
| Regulator output current in shutdown | $V_{SHUTDOWN} \geq 2 \text{ V}$, $V_{IN} \leq 30 \text{ V}$, $V_{OUT} = 0$, FEEDBACK tied to V_{TAP} | 25°C | | 3 | 10 | μA |
| | | –40°C to 125°C | | | 20 | |

- (5) Comparator thresholds are expressed in terms of a voltage differential equal to the nominal reference voltage (measured at $V_{IN} - V_{OUT} = 1 \text{ V}$) minus FEEDBACK terminal voltage. To express these thresholds in terms of output voltage change, multiply by the error amplifier gain = $V_{OUT}/V_{REF} = (R1 + R2)/R2$. For example, at a programmed output voltage of 5 V, the ERROR output is specified to go low when the output drops by $95 \text{ mV} \times 5 \text{ V}/1.235 \text{ V} = 384 \text{ mV}$. Thresholds remain constant as a percentage of V_{OUT} (as V_{OUT} is varied), with the low-output warning occurring at 6% below nominal (typ) and 7.7% (max).
- (6) Comparator thresholds are expressed in terms of a voltage differential equal to the nominal reference voltage (measured at $V_{IN} - V_{OUT} = 1 \text{ V}$) minus FEEDBACK terminal voltage. To express these thresholds in terms of output voltage change, multiply by the error amplifier gain = $V_{OUT}/V_{REF} = (R1 + R2)/R2$. For example, at a programmed output voltage of 5 V, the ERROR output is specified to go low when the output drops by $95 \text{ mV} \times 5 \text{ V}/1.235 \text{ V} = 384 \text{ mV}$. Thresholds remain constant as a percentage of V_{OUT} (as V_{OUT} is varied), with the low-output warning occurring at 6% below nominal (typ) and 7.7% (max).

TYPICAL CHARACTERISTICS

**QUIESCENT CURRENT
VS
LOAD CURRENT**

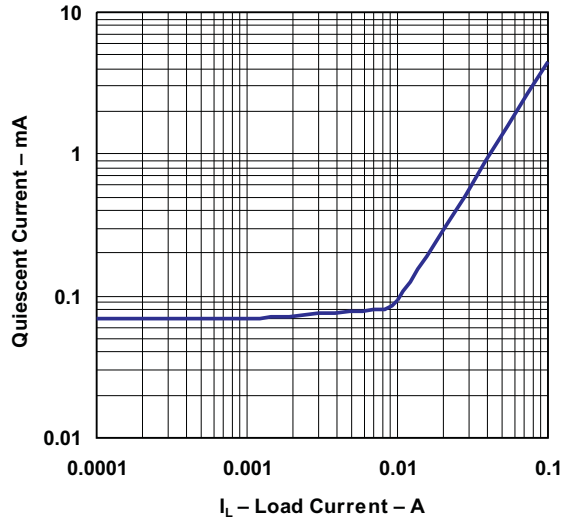

**INPUT CURRENT
VS
INPUT VOLTAGE**

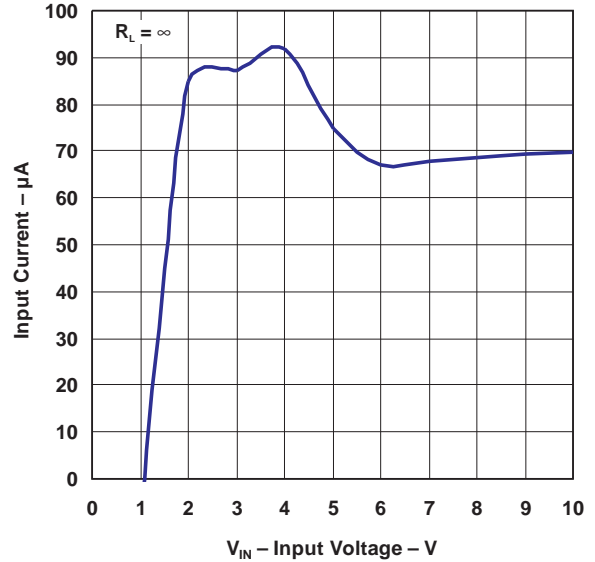

**INPUT CURRENT
VS
INPUT VOLTAGE**

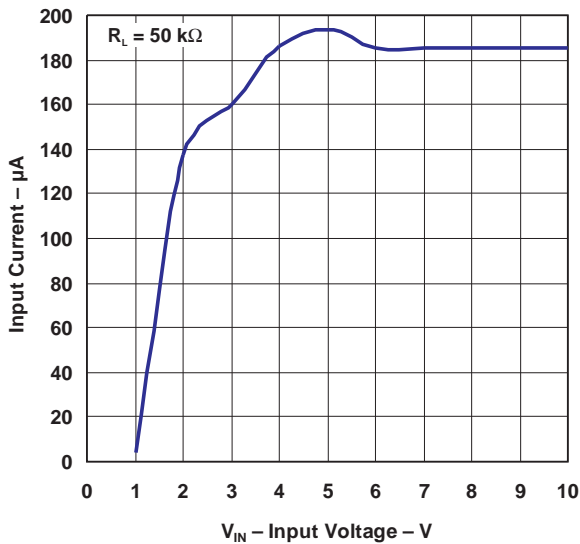

**INPUT CURRENT
VS
INPUT VOLTAGE**

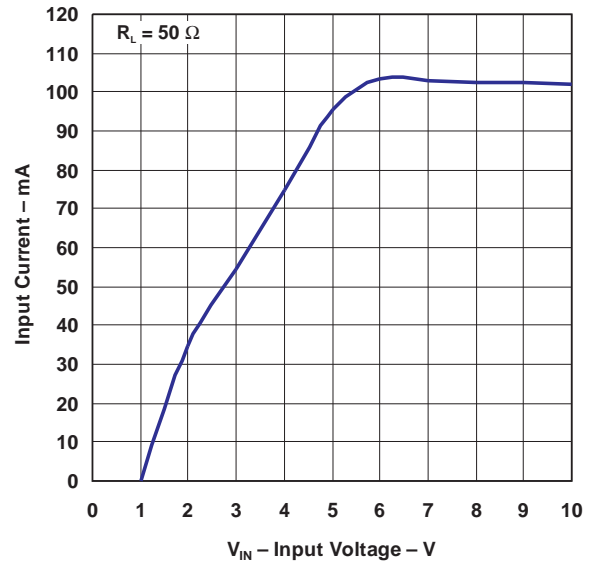

TYPICAL CHARACTERISTICS (continued)

OUTPUT VOLTAGE
 VS
 TEMPERATURE

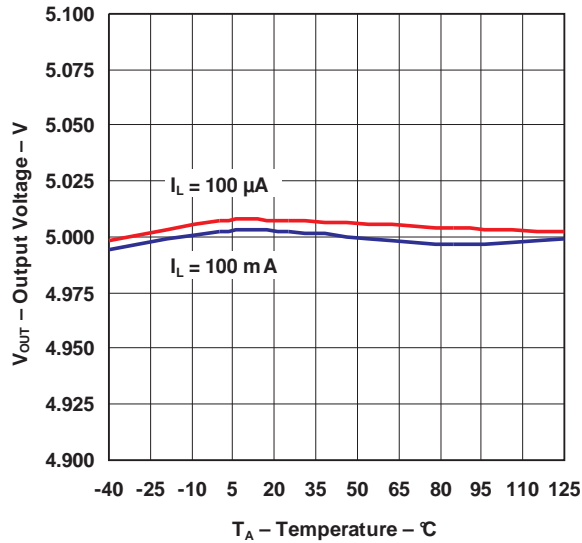

QUIESCENT CURRENT
 VS
 INPUT VOLTAGE

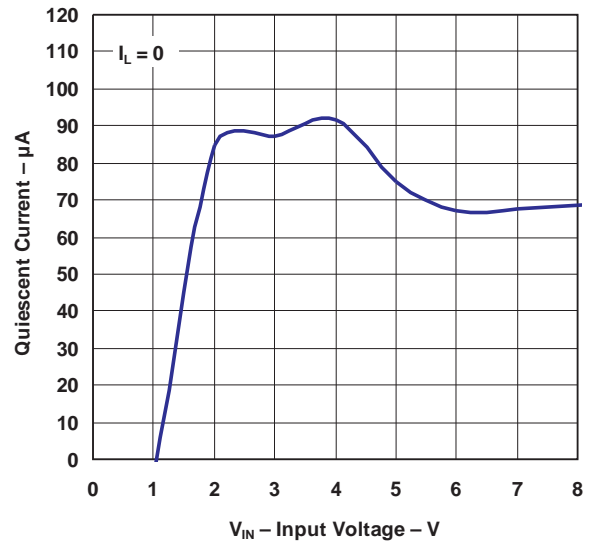

QUIESCENT CURRENT
 VS
 INPUT VOLTAGE

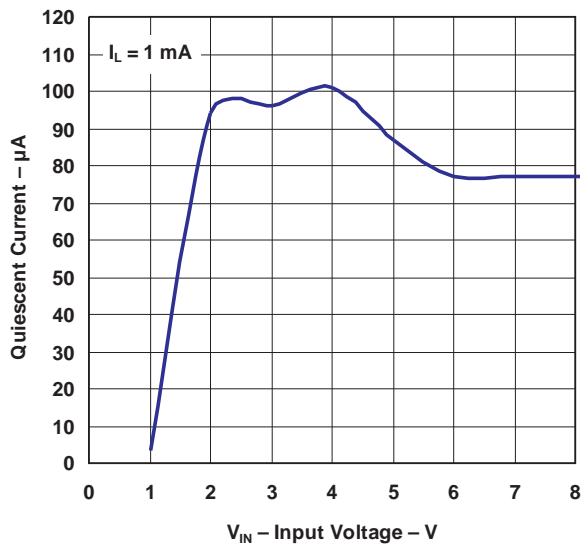

QUIESCENT CURRENT
 VS
 INPUT VOLTAGE

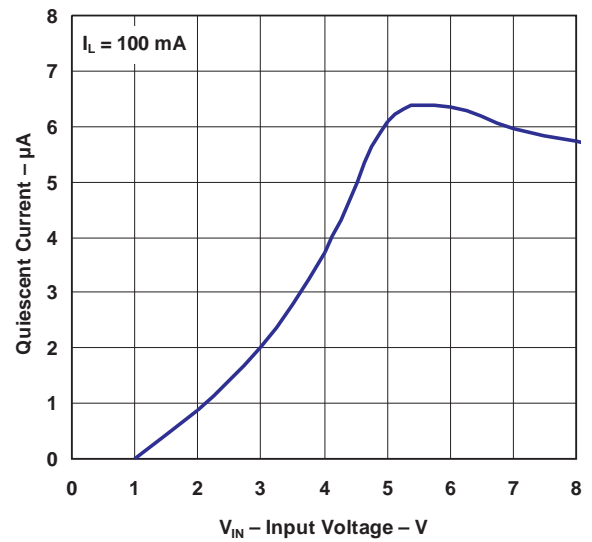

TYPICAL CHARACTERISTICS (continued)

**QUIESCENT CURRENT
VS
TEMPERATURE**

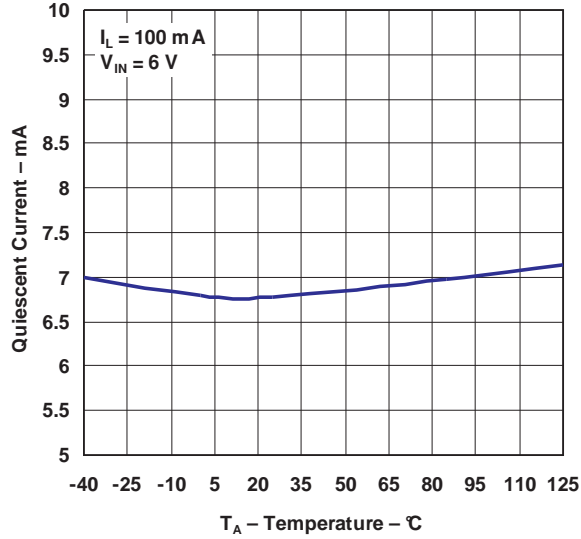

**QUIESCENT CURRENT
VS
TEMPERATURE**

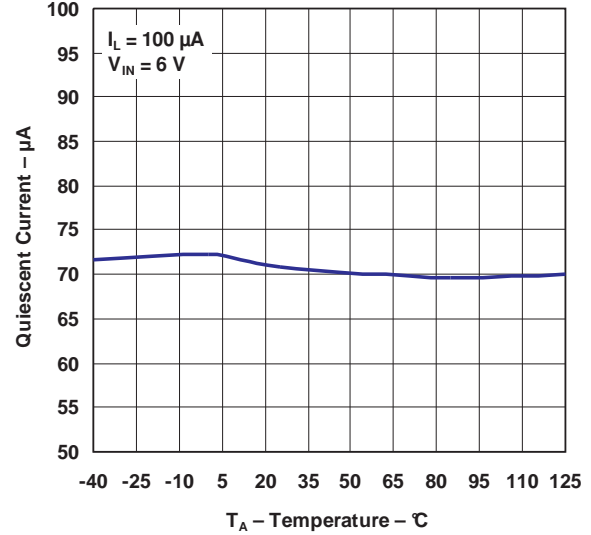

**SHORT-CIRCUIT CURRENT
VS
TEMPERATURE**

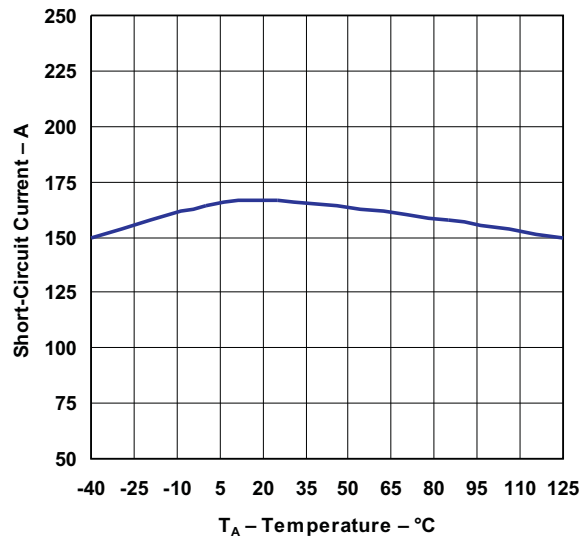

**DROPOUT VOLTAGE
VS
TEMPERATURE**

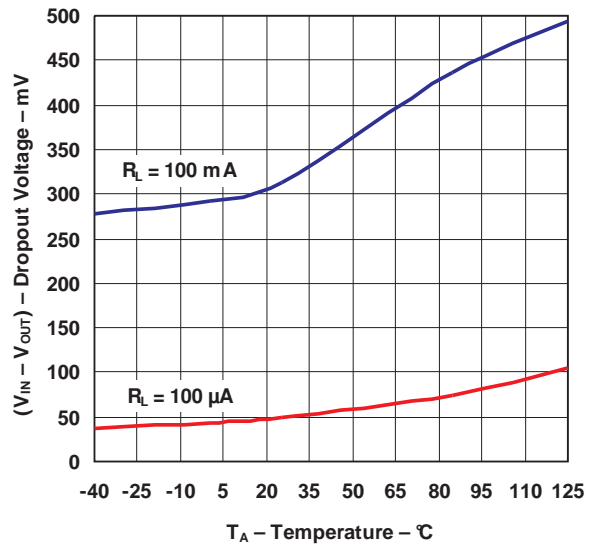

TYPICAL CHARACTERISTICS (continued)

DROPOUT VOLTAGE
 VS
 OUTPUT CURRENT

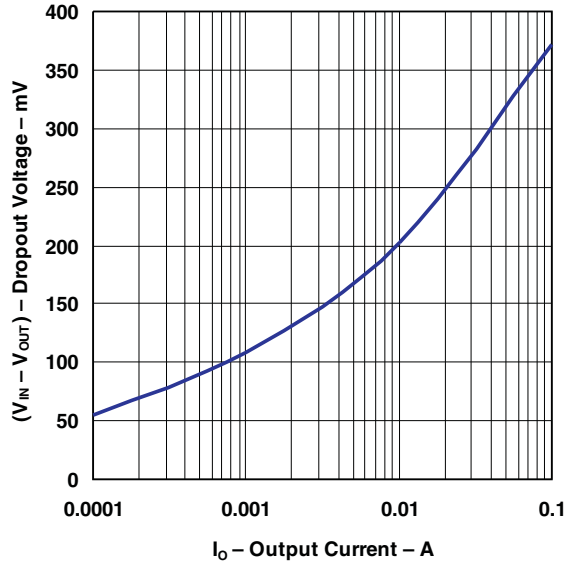

LP2951 MINIMUM OPERATING VOLTAGE
 VS
 TEMPERATURE

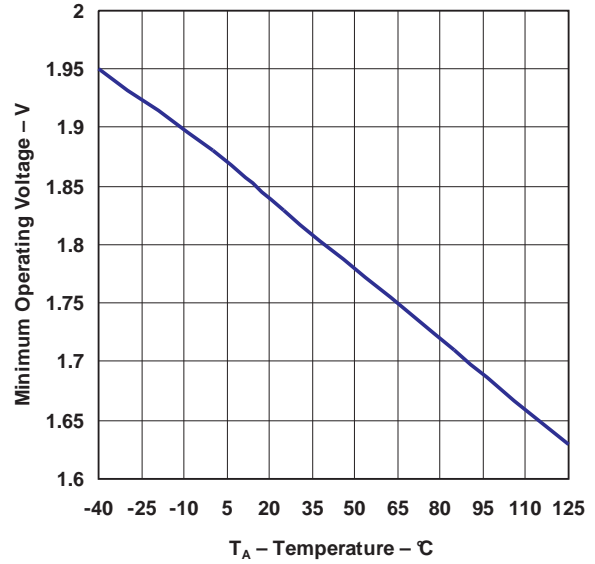

LP2951 FEEDBACK BIAS CURRENT
 VS
 TEMPERATURE

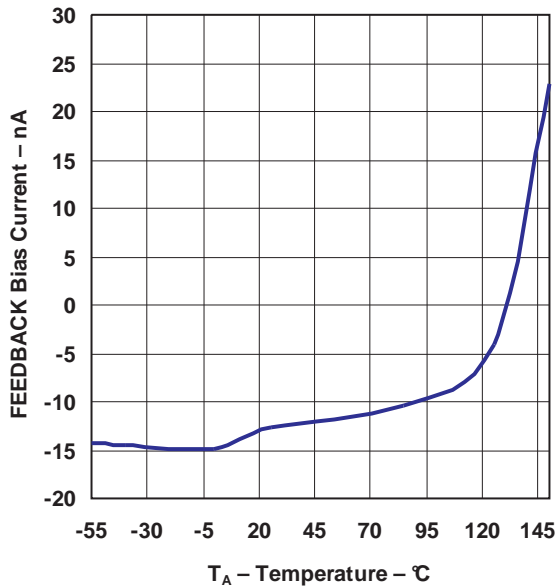

LP2951 ERROR COMPARATOR OUTPUT
 VS
 INPUT VOLTAGE

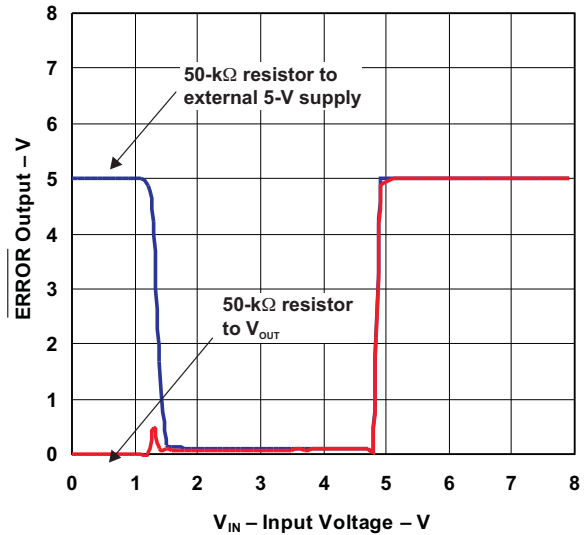

TYPICAL CHARACTERISTICS (continued)

LP2951 ERROR COMPARATOR SINK CURRENT
VS
OUTPUT LOW VOLTAGE

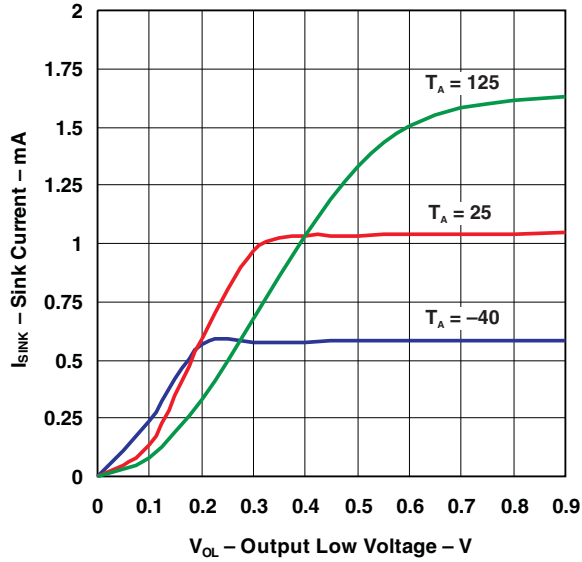

LINE TRANSIENT RESPONSE
VS
TIME

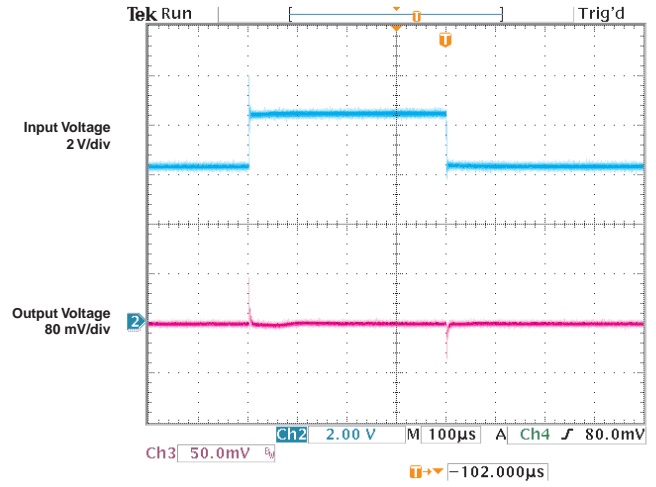

LOAD TRANSIENT RESPONSE
VS
TIME
($V_{OUT} = 5$ V, $C_L = 1$ μ F)

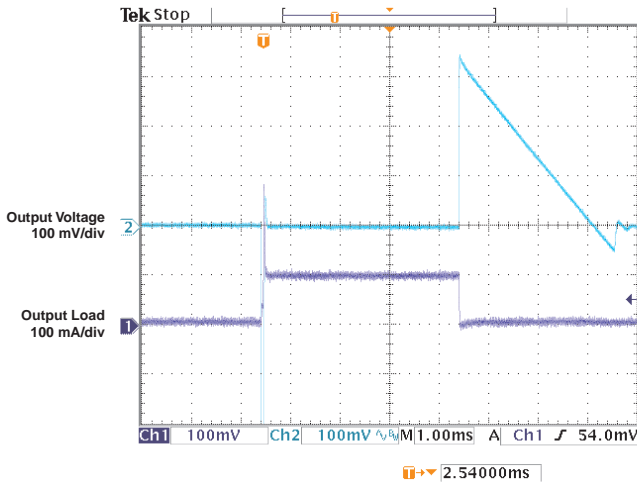

LOAD TRANSIENT RESPONSE
VS
TIME
($V_{OUT} = 5$ V, $C_L = 10$ μ F)

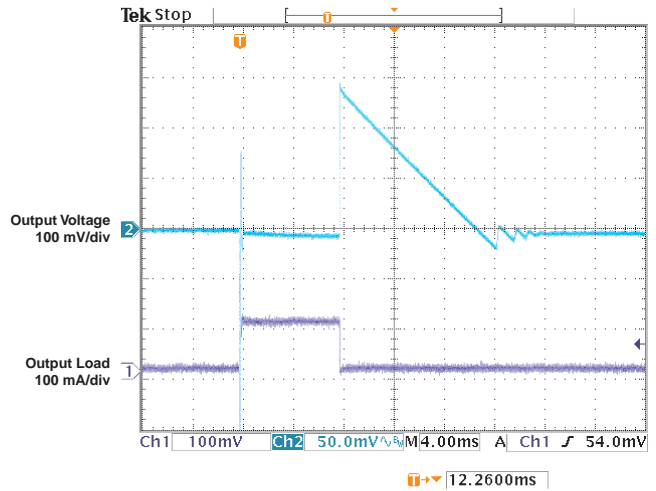

TYPICAL CHARACTERISTICS (continued)

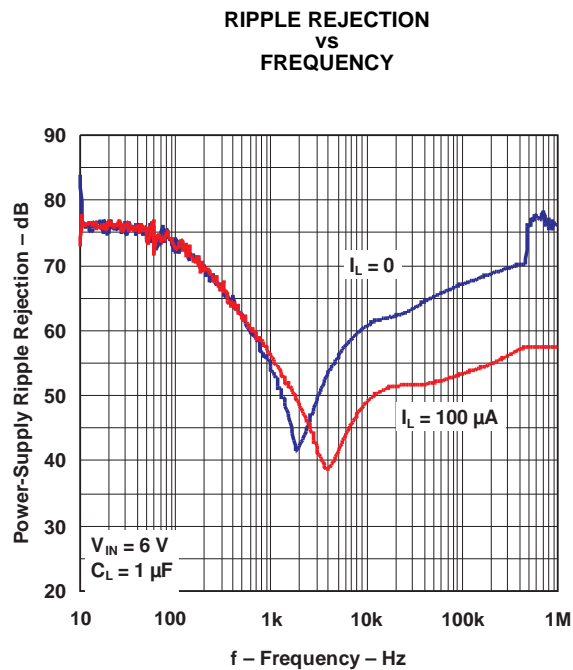
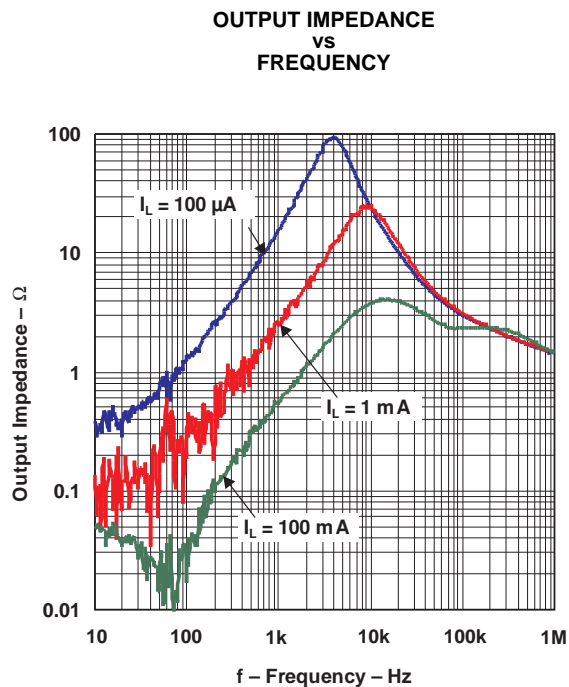
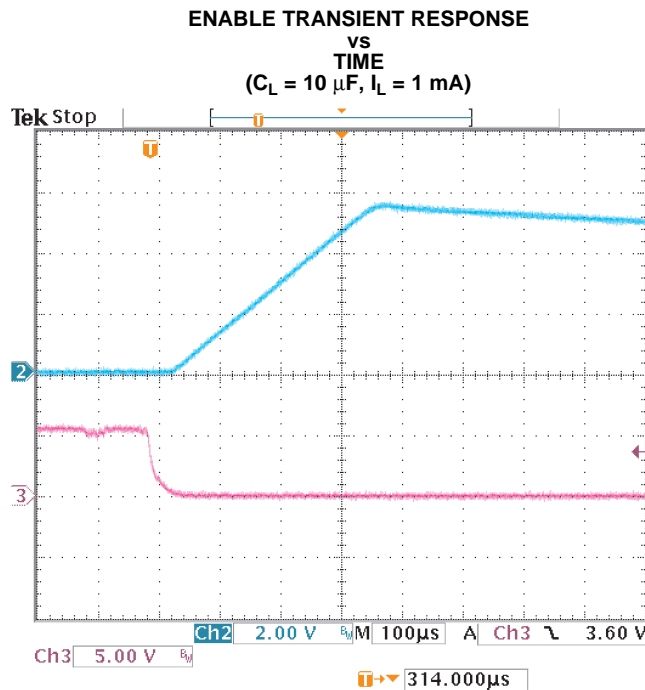
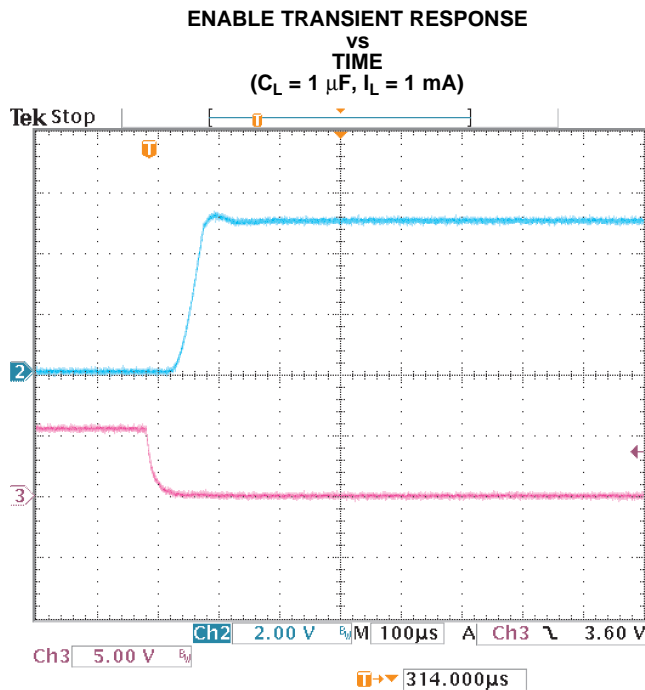

TYPICAL CHARACTERISTICS (continued)

RIPPLE REJECTION
VS
FREQUENCY

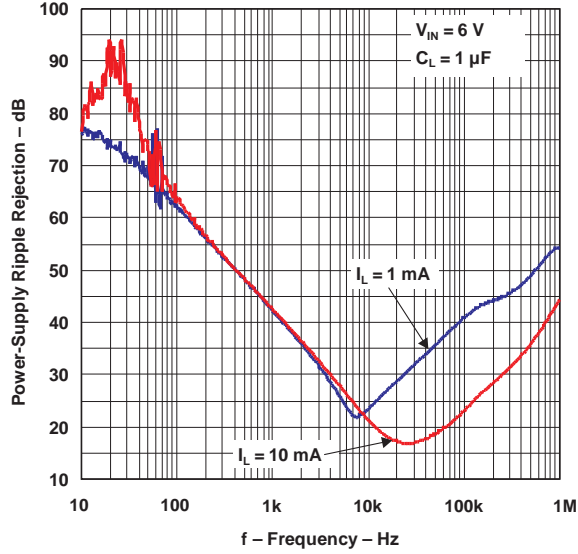

RIPPLE REJECTION
VS
FREQUENCY

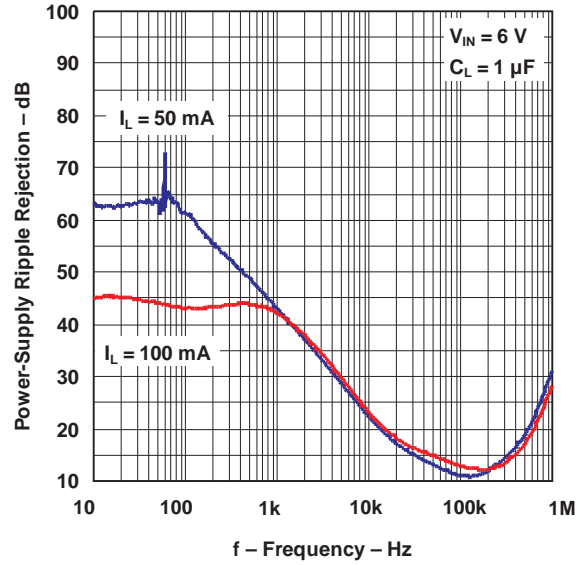

LP2951 OUTPUT NOISE
VS
FREQUENCY

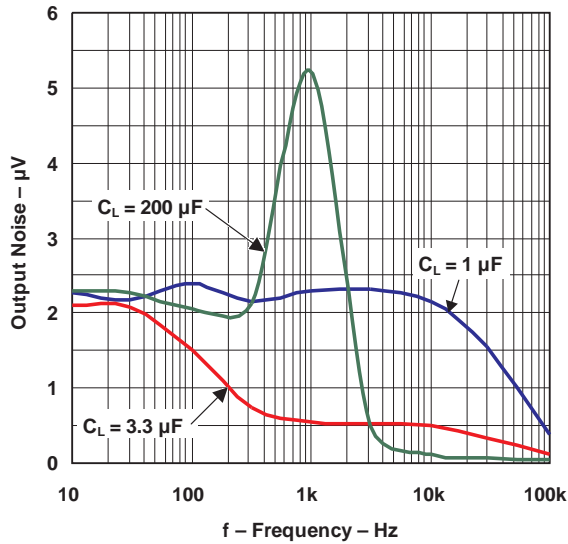

LP2951 DIVIDER RESISTANCE
VS
TEMPERATURE

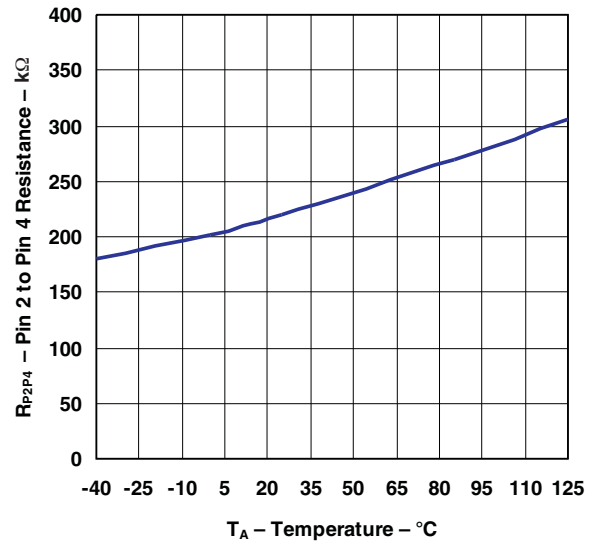

TYPICAL CHARACTERISTICS (continued)

SHUTDOWN THRESHOLD VOLTAGE (OFF TO ON)
 VS
 TEMPERATURE

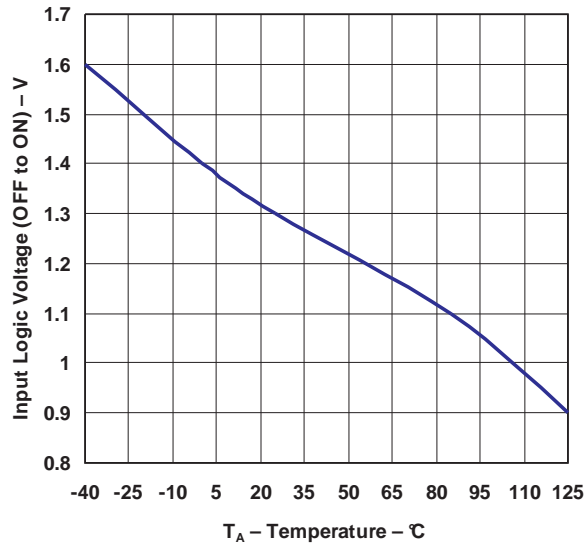

SHUTDOWN THRESHOLD VOLTAGE (ON TO OFF)
 VS
 TEMPERATURE

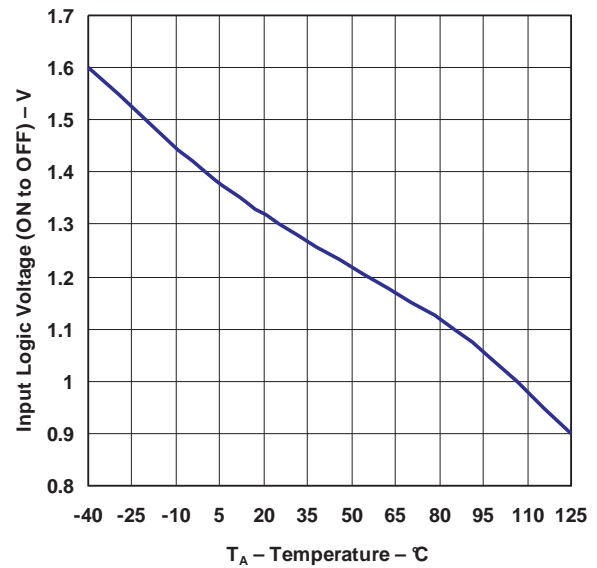

LINE REGULATION
 VS
 INPUT VOLTAGE

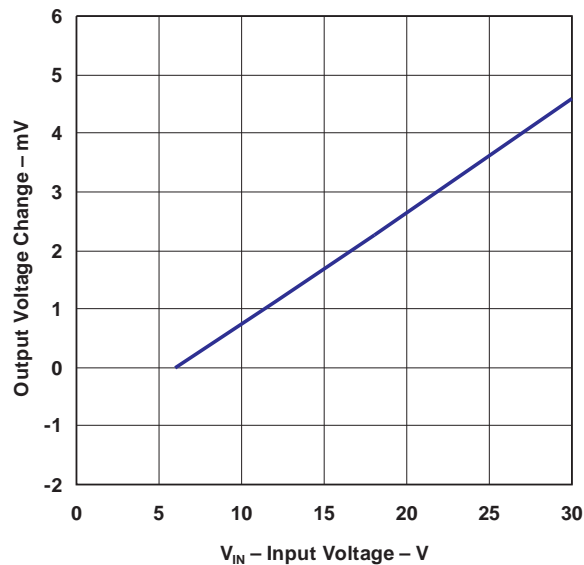

APPLICATION INFORMATION

Input Capacitor (C_{IN})

A 1- μ F (tantalum, ceramic, or aluminum) electrolytic capacitor should be placed locally at the input of the LP2950 or LP2951 if there is, or will be, significant impedance between the ac filter capacitor and the input; for example, if a battery is used as the input or if the ac filter capacitor is located more than 10 in away. There are no ESR requirements for this capacitor, and the capacitance can be increased without limit.

Output Capacitor (C_{OUT})

As with most PNP LDOs, stability conditions require the output capacitor to have a minimum capacitance and an ESR that falls within a certain range.

Capacitance Value

For $V_{OUT} \geq 5$ V, a minimum of 1 μ F is required. For lower V_{OUT} , the regulator's loop gain is running closer to unity gain and, thus, has lower phase margins. Consequently, a larger capacitance is needed for stability. For $V_{OUT} = 3$ V or 3.3 V, a minimum of 2.2 μ F is recommended. For worst case, $V_{OUT} = 1.23$ V (using the ADJ version), a minimum of 3.3 μ F is recommended. C_{OUT} can be increased without limit and only improves the regulator stability and transient response. Regardless of its value, the output capacitor should have a resonant frequency less than 500 kHz.

The minimum capacitance values given above are for maximum load current of 100 mA. If the maximum expected load current is less than 100 mA, then lower values of C_{OUT} can be used. For instance, if $I_{OUT} < 10$ mA, then only 0.33 μ F is required for C_{OUT} . For $I_{OUT} < 1$ mA, 0.1 μ F is sufficient for stability requirements. Thus, for a worst-case condition of 100-mA load and $V_{OUT} = V_{REF} = 1.235$ V (representing the highest load current and lowest loop gain), a minimum C_{OUT} of 3.3 μ F is recommended.

For the LP2950, no load stability is inherent in the design — a desirable feature in CMOS circuits that are put in standby (such as RAM keep-alive applications). If the LP2951 is used with external resistors to set the output voltage, a minimum load current of 1 μ A is recommended through the resistor divider.

ESR Range

The regulator control loop relies on the ESR of the output capacitor to provide a zero to add sufficient phase margin to ensure unconditional regulator stability; this requires the closed-loop gain to intersect the open-loop response in a region where the open-loop gain rolls off at 20 dB/decade. This ensures that the phase always is less than 180° (phase margin greater than 0°) at unity gain. Thus, a minimum-maximum range for the ESR must be observed.

The upper limit of this ESR range is established by the fact that too high an ESR could result in the zero occurring too soon, causing the gain to roll off too slowly, which, in turn allows a third pole to appear before unity gain and introduce enough phase shift to cause instability. This typically limits the max ESR to approximately 5 Ω .

Conversely, the lower limit of the ESR is tied to the fact that too low an ESR shifts the zero too far out (past unity gain) and, thus, allows the gain to roll off at 40 dB/decade at unity gain, with a resulting phase shift of greater than 180°. Typically, this limits the minimum ESR to approximately 20 m Ω to 30 m Ω .

For specific ESR requirements, see *Typical Characteristics*.

APPLICATION INFORMATION (continued)

Capacitor Types

Most tantalum or aluminum electrolytics are suitable for use at the input. Film-type capacitors also work, but at higher cost. When operating at low temperature, care should be taken with aluminum electrolytics, as their electrolytes often freeze at -30°C . For this reason, solid tantalum capacitors should be used at temperatures below -25°C .

Ceramic capacitors can be used, but due to their low ESR (as low as $5\text{ m}\Omega$ to $10\text{ m}\Omega$), they may not meet the minimum ESR requirement previously discussed. If a ceramic capacitor is used, a series resistor between $0.1\ \Omega$ to $2\ \Omega$ must be added to meet the minimum ESR requirement. In addition, ceramic capacitors have one glaring disadvantage that must be taken into account — a poor temperature coefficient, where the capacitance can vary significantly with temperature. For instance, a large-value ceramic capacitor ($\geq 2.2\ \mu\text{F}$) can lose more than half of its capacitance as temperature rises from 25°C to 85°C . Thus, a $2.2\text{-}\mu\text{F}$ capacitor at 25°C drops well below the minimum C_{OUT} required for stability as ambient temperature rises. For this reason, select an output capacitor that maintains the minimum $2.2\text{-}\mu\text{F}$ required for stability for the entire operating temperature range.

C_{BYPASS} : Noise and Stability Improvement

In the LP2951, an external FEEDBACK pin directly connected to the error amplifier noninverting input can allow stray capacitance to cause instability by shunting the error amplifier feedback to GND, especially at high frequencies. This is worsened if high-value external resistors are used to set the output voltage, because a high resistance allows the stray capacitance to play a more significant role; i.e., a larger RC time delay is introduced between the output of the error amplifier and its FEEDBACK input, leading to more phase shift and lower phase margin. A solution is to add a 100-pF bypass capacitor (C_{BYPASS}) between OUTPUT and FEEDBACK; because C_{BYPASS} is in parallel with $R1$, it lowers the impedance seen at FEEDBACK at high frequencies, in effect offsetting the effect of the parasitic capacitance by providing more feedback at higher frequencies. More feedback forces the error amplifier to work at a lower loop gain, so C_{OUT} should be increased to a minimum of $3.3\ \mu\text{F}$ to improve the regulator's phase margin.

C_{BYPASS} can be also used to reduce output noise in the LP2951. This bypass capacitor reduces the closed loop gain of the error amplifier at the high frequency, so noise no longer scales with the output voltage. This improvement is more noticeable with higher output voltages, because loop gain reduction is greatest. A suitable C_{BYPASS} is calculated as shown in Equation 1:

$$f_{(\text{CBYPASS})} \approx 200\text{ Hz} \rightarrow C_{\text{BYPASS}} = \frac{1}{2\pi \times R1 \times 200\text{ Hz}} \quad (1)$$

On the 3-pin LP2950, noise reduction can be achieved by increasing the output capacitor, which causes the regulator bandwidth to be reduced, therefore, eliminating high-frequency noise. However, this method is relatively inefficient, as increasing C_{OUT} from $1\ \mu\text{F}$ to $220\ \mu\text{F}$ only reduces the regulator's output noise from $430\ \mu\text{V}$ to $160\ \mu\text{V}$ (over a 100-kHz bandwidth).

$\overline{\text{ERROR}}$ Function (LP2951 Only)

The LP2951 has a low-voltage detection comparator that outputs a logic low when the output voltage drops by $\approx 6\%$ from its nominal value, and outputs a logic high when V_{OUT} has reached $\approx 95\%$ of its nominal value. This 95% of nominal figure is obtained by dividing the built-in offset of $\approx 60\text{ mV}$ by the 1.235-V bandgap reference, and remains independent of the programmed output voltage. For example, the trip-point threshold ($\overline{\text{ERROR}}$ output goes high) typically is 4.75 V for a 5-V output and 11.4 V for a 12-V output. Typically, there is a hysteresis of 15 mV between the thresholds for high and low $\overline{\text{ERROR}}$ output.

A timing diagram is shown in Figure 1 for $\overline{\text{ERROR}}$ vs V_{OUT} (5 V), as V_{IN} is ramped up and down. $\overline{\text{ERROR}}$ becomes valid (low) when $V_{\text{IN}} \approx 1.3\text{ V}$. When $V_{\text{IN}} \approx 5\text{ V}$, $V_{\text{OUT}} = 4.75\text{ V}$, causing $\overline{\text{ERROR}}$ to go high. Because the dropout voltage is load dependent, the output trip-point threshold is reached at different values of V_{IN} , depending on the load current. For instance, at higher load current, $\overline{\text{ERROR}}$ goes high at a slightly higher value of V_{IN} , and vice versa for lower load current. The output-voltage trip point remains at $\approx 4.75\text{ V}$, regardless of the load. Note that when $V_{\text{IN}} \leq 1.3\text{ V}$, the $\overline{\text{ERROR}}$ comparator output is turned off and pulled high to its pullup voltage. If V_{OUT} is used as the pullup voltage, rather than an external 5-V source, $\overline{\text{ERROR}}$ typically is $\approx 1.2\text{ V}$. In this condition, an equal resistor divider ($10\text{ k}\Omega$ is suitable) can be tied to $\overline{\text{ERROR}}$ to divide down the voltage to a valid logic low during any fault condition, while still enabling a logic high during normal operation.

APPLICATION INFORMATION (continued)

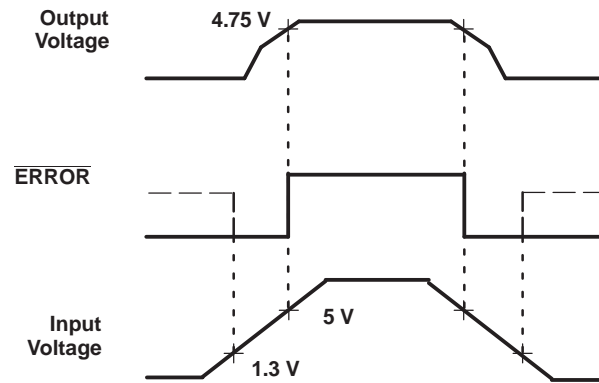

Figure 1. $\overline{\text{ERROR}}$ Output Timing

Because the $\overline{\text{ERROR}}$ comparator has an open-collector output, an external pullup resistor is required to pull the output up to V_{OUT} or another supply voltage (up to 30 V). The output of the comparator is rated to sink up to 400 μA . A suitable range of values for the pullup resistor is from 100 k Ω to 1 M Ω . If $\overline{\text{ERROR}}$ is not used, it can be left open.

Programming Output Voltage (LP2951 Only)

A unique feature of the LP2951 is its ability to output either a fixed voltage or an adjustable voltage, depending on the external pin connections. To output the internally programmed fixed voltage, tie the SENSE pin to the OUTPUT pin and the FEEDBACK pin to the V_{TAP} pin. Alternatively, a user-programmable voltage ranging from the internal 1.235-V reference to a 30-V max can be set by using an external resistor divider pair. The resistor divider is tied to V_{OUT} , and the divided-down voltage is tied directly to FEEDBACK for comparison against the internal 1.235-V reference. To satisfy the steady-state condition in which its two inputs are equal, the error amplifier drives the output to equal [Equation 2](#):

$$V_{\text{OUT}} = V_{\text{REF}} \times \left(1 + \frac{R_1}{R_2} \right) - I_{\text{FB}} R_1 \quad (2)$$

Where:

$V_{\text{REF}} = 1.235 \text{ V}$ applied across R2

$I_{\text{FB}} = \text{FEEDBACK bias current, typically } 20 \text{ nA}$

A minimum regulator output current of 1 μA must be maintained. Thus, in an application where a no-load condition is expected (for example, CMOS circuits in standby), this 1- μA minimum current must be provided by the resistor pair, effectively imposing a maximum value of $R_2 = 1.2 \text{ M}\Omega$ ($1.235 \text{ V}/1.2 \text{ M}\Omega \approx 1 \mu\text{A}$).

$I_{\text{FB}} = 20 \text{ nA}$ introduces an error of $\approx 0.02\%$ in V_{OUT} . This can be offset by trimming R1. Alternatively, increasing the divider current makes I_{FB} less significant, thus, reducing its error contribution. For instance, using $R_2 = 100 \text{ k}\Omega$ reduces the error contribution of I_{FB} to 0.17% by increasing the divider current to $\approx 12 \mu\text{A}$. This increase in the divider current still is small compared to the 600- μA typical quiescent current of the LP2951 under no load.

PACKAGING INFORMATION

| Orderable Device | Status ⁽¹⁾ | Package Type | Package Drawing | Pins | Package Qty | Eco Plan ⁽²⁾ | Lead/Ball Finish | MSL Peak Temp ⁽³⁾ |
|------------------|-----------------------|--------------|-----------------|------|-------------|-------------------------|------------------|------------------------------|
| LP2950-30LP | ACTIVE | TO-92 | LP | 3 | 1000 | Pb-Free (RoHS) | CU SN | N / A for Pkg Type |
| LP2950-30LPR | ACTIVE | TO-92 | LP | 3 | 2000 | Pb-Free (RoHS) | CU SN | N / A for Pkg Type |
| LP2950-33LPE3 | ACTIVE | TO-92 | LP | 3 | 1000 | Pb-Free (RoHS) | CU SN | N / A for Pkg Type |
| LP2950-33LPRE3 | ACTIVE | TO-92 | LP | 3 | 2000 | Pb-Free (RoHS) | CU SN | N / A for Pkg Type |
| LP2950-50LPRE3 | ACTIVE | TO-92 | LP | 3 | 2000 | Pb-Free (RoHS) | CU SN | N / A for Pkg Type |
| LP2951-30D | ACTIVE | SOIC | D | 8 | 75 | Green (RoHS & no Sb/Br) | CU NIPDAU | Level-1-260C-UNLIM |
| LP2951-30DG4 | ACTIVE | SOIC | D | 8 | 75 | Green (RoHS & no Sb/Br) | CU NIPDAU | Level-1-260C-UNLIM |
| LP2951-30DR | ACTIVE | SOIC | D | 8 | 2500 | Green (RoHS & no Sb/Br) | CU NIPDAU | Level-1-260C-UNLIM |
| LP2951-30DRG4 | ACTIVE | SOIC | D | 8 | 2500 | Green (RoHS & no Sb/Br) | CU NIPDAU | Level-1-260C-UNLIM |
| LP2951-33D | ACTIVE | SOIC | D | 8 | 75 | Green (RoHS & no Sb/Br) | CU NIPDAU | Level-1-260C-UNLIM |
| LP2951-33DG4 | ACTIVE | SOIC | D | 8 | 75 | Green (RoHS & no Sb/Br) | CU NIPDAU | Level-1-260C-UNLIM |
| LP2951-33DR | ACTIVE | SOIC | D | 8 | 2500 | Green (RoHS & no Sb/Br) | CU NIPDAU | Level-1-260C-UNLIM |
| LP2951-33DRG4 | ACTIVE | SOIC | D | 8 | 2500 | Green (RoHS & no Sb/Br) | CU NIPDAU | Level-1-260C-UNLIM |
| LP2951-50D | ACTIVE | SOIC | D | 8 | 75 | Green (RoHS & no Sb/Br) | CU NIPDAU | Level-1-260C-UNLIM |
| LP2951-50DG4 | ACTIVE | SOIC | D | 8 | 75 | Green (RoHS & no Sb/Br) | CU NIPDAU | Level-1-260C-UNLIM |
| LP2951-50DR | ACTIVE | SOIC | D | 8 | 2500 | Green (RoHS & no Sb/Br) | CU NIPDAU | Level-1-260C-UNLIM |
| LP2951-50DRG4 | ACTIVE | SOIC | D | 8 | 2500 | Green (RoHS & no Sb/Br) | CU NIPDAU | Level-1-260C-UNLIM |
| LP2951D | ACTIVE | SOIC | D | 8 | 75 | Green (RoHS & no Sb/Br) | CU NIPDAU | Level-1-260C-UNLIM |
| LP2951DR | ACTIVE | SOIC | D | 8 | 2500 | Green (RoHS & no Sb/Br) | CU NIPDAU | Level-1-260C-UNLIM |

⁽¹⁾ The marketing status values are defined as follows:

ACTIVE: Product device recommended for new designs.

LIFEBUY: TI has announced that the device will be discontinued, and a lifetime-buy period is in effect.

NRND: Not recommended for new designs. Device is in production to support existing customers, but TI does not recommend using this part in a new design.

PREVIEW: Device has been announced but is not in production. Samples may or may not be available.

OBSOLETE: TI has discontinued the production of the device.

⁽²⁾ Eco Plan - The planned eco-friendly classification: Pb-Free (RoHS), Pb-Free (RoHS Exempt), or Green (RoHS & no Sb/Br) - please check <http://www.ti.com/productcontent> for the latest availability information and additional product content details.

TBD: The Pb-Free/Green conversion plan has not been defined.

Pb-Free (RoHS): TI's terms "Lead-Free" or "Pb-Free" mean semiconductor products that are compatible with the current RoHS requirements for all 6 substances, including the requirement that lead not exceed 0.1% by weight in homogeneous materials. Where designed to be soldered

at high temperatures, TI Pb-Free products are suitable for use in specified lead-free processes.

Pb-Free (RoHS Exempt): This component has a RoHS exemption for either 1) lead-based flip-chip solder bumps used between the die and package, or 2) lead-based die adhesive used between the die and leadframe. The component is otherwise considered Pb-Free (RoHS compatible) as defined above.

Green (RoHS & no Sb/Br): TI defines "Green" to mean Pb-Free (RoHS compatible), and free of Bromine (Br) and Antimony (Sb) based flame retardants (Br or Sb do not exceed 0.1% by weight in homogeneous material)

⁽³⁾ MSL, Peak Temp. -- The Moisture Sensitivity Level rating according to the JEDEC industry standard classifications, and peak solder temperature.

Important Information and Disclaimer:The information provided on this page represents TI's knowledge and belief as of the date that it is provided. TI bases its knowledge and belief on information provided by third parties, and makes no representation or warranty as to the accuracy of such information. Efforts are underway to better integrate information from third parties. TI has taken and continues to take reasonable steps to provide representative and accurate information but may not have conducted destructive testing or chemical analysis on incoming materials and chemicals. TI and TI suppliers consider certain information to be proprietary, and thus CAS numbers and other limited information may not be available for release.

In no event shall TI's liability arising out of such information exceed the total purchase price of the TI part(s) at issue in this document sold by TI to Customer on an annual basis.



Carrier tape design is defined largely by the component length, width, and thickness.

| |
|--|
| A_o = Dimension designed to accommodate the component width. |
| B_o = Dimension designed to accommodate the component length. |
| K_o = Dimension designed to accommodate the component thickness. |
| W = Overall width of the carrier tape. |
| P = Pitch between successive cavity centers. |

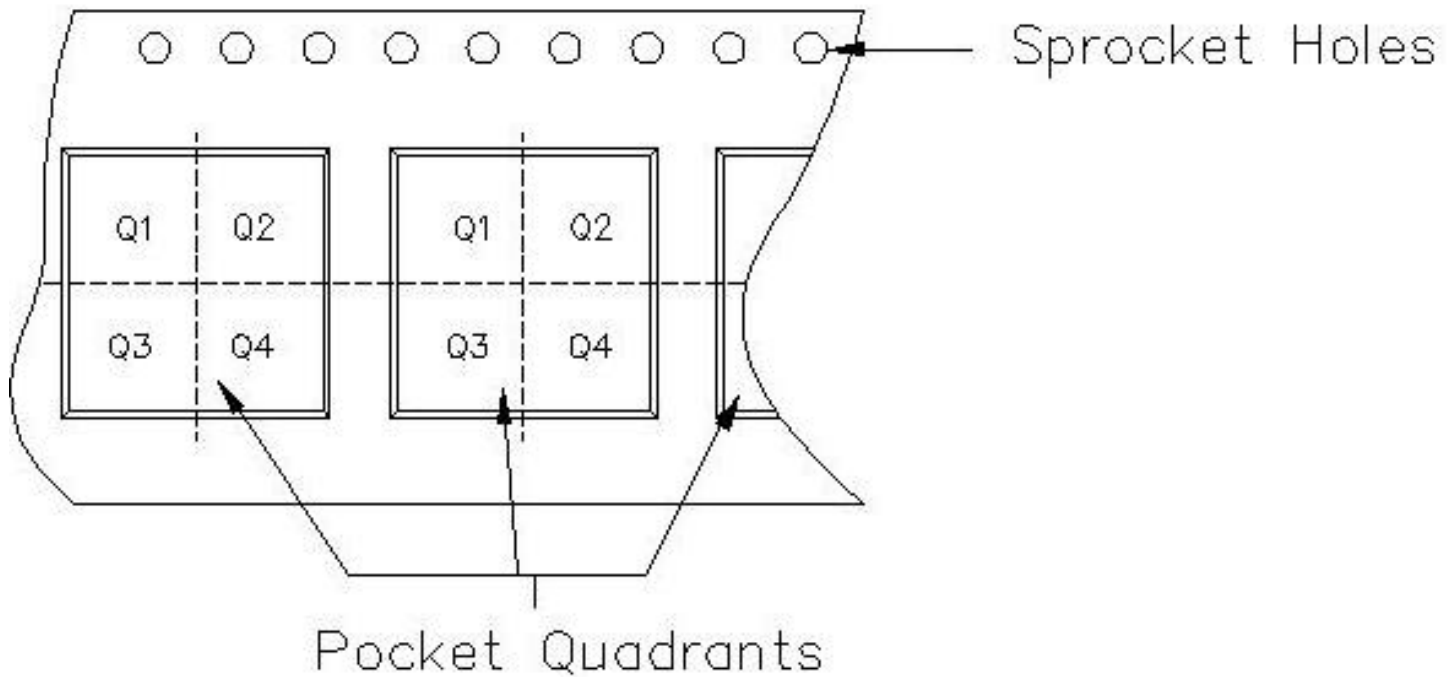

TAPE AND REEL INFORMATION

| Device | Package | Pins | Site | Reel Diameter (mm) | Reel Width (mm) | A0 (mm) | B0 (mm) | K0 (mm) | P1 (mm) | W (mm) | Pin1 Quadrant |
|-------------|---------|------|------|--------------------|-----------------|---------|---------|---------|---------|--------|---------------|
| LP2951-30DR | D | 8 | FMX | 330 | 12 | 6.4 | 5.2 | 2.1 | 8 | 12 | Q1 |
| LP2951-33DR | D | 8 | FMX | 330 | 12 | 6.4 | 5.2 | 2.1 | 8 | 12 | Q1 |
| LP2951-50DR | D | 8 | FMX | 330 | 12 | 6.4 | 5.2 | 2.1 | 8 | 12 | Q1 |
| LP2951DR | D | 8 | FMX | 330 | 12 | 6.4 | 5.2 | 2.1 | 8 | 12 | Q1 |

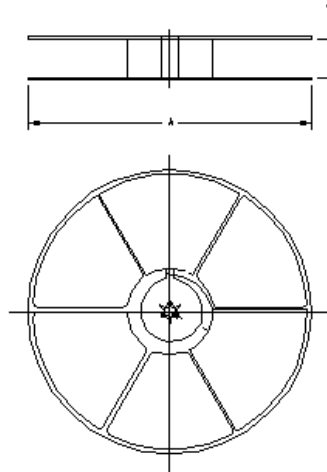

TAPE AND REEL BOX INFORMATION

| Device | Package | Pins | Site | Length (mm) | Width (mm) | Height (mm) |
|-------------|---------|------|------|-------------|------------|-------------|
| LP2951-30DR | D | 8 | FMX | 342.9 | 336.6 | 20.64 |
| LP2951-33DR | D | 8 | FMX | 342.9 | 336.6 | 20.64 |
| LP2951-50DR | D | 8 | FMX | 342.9 | 336.6 | 20.64 |
| LP2951DR | D | 8 | FMX | 342.9 | 336.6 | 20.64 |

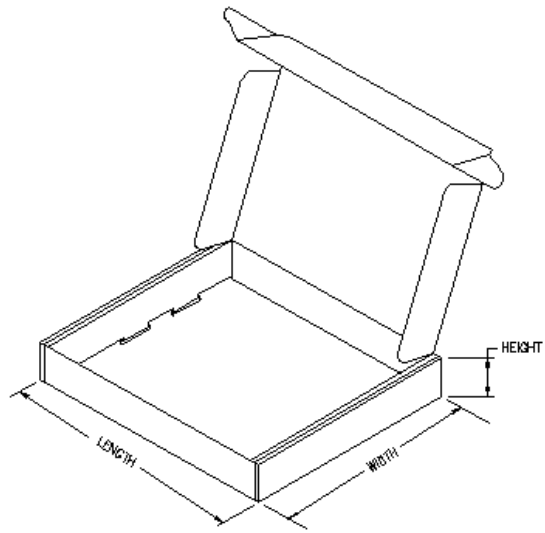

D (R-PDSO-G8)

PLASTIC SMALL-OUTLINE PACKAGE



- NOTES:
- A. All linear dimensions are in inches (millimeters).
 - B. This drawing is subject to change without notice.
 - C. Body length does not include mold flash, protrusions, or gate burrs. Mold flash, protrusions, or gate burrs shall not exceed .006 (0,15) per end.
 - D. Body width does not include interlead flash. Interlead flash shall not exceed .017 (0,43) per side.
 - E. Reference JEDEC MS-012 variation AA.

LP (O-PBCY-W3)

PLASTIC CYLINDRICAL PACKAGE



- NOTES: A. All linear dimensions are in inches (millimeters).
 B. This drawing is subject to change without notice.
 C. Lead dimensions are not controlled within this area
 D. Falls within JEDEC TO -226 Variation AA (TO-226 replaces TO-92)
 E. Shipping Method:
 Straight lead option available in bulk pack only.
 Formed lead option available in tape & reel or ammo pack.

MECHANICAL DATA

MSOT002A – OCTOBER 1994 – REVISED NOVEMBER 2001

LP (O-PBCY-W3)

PLASTIC CYLINDRICAL PACKAGE

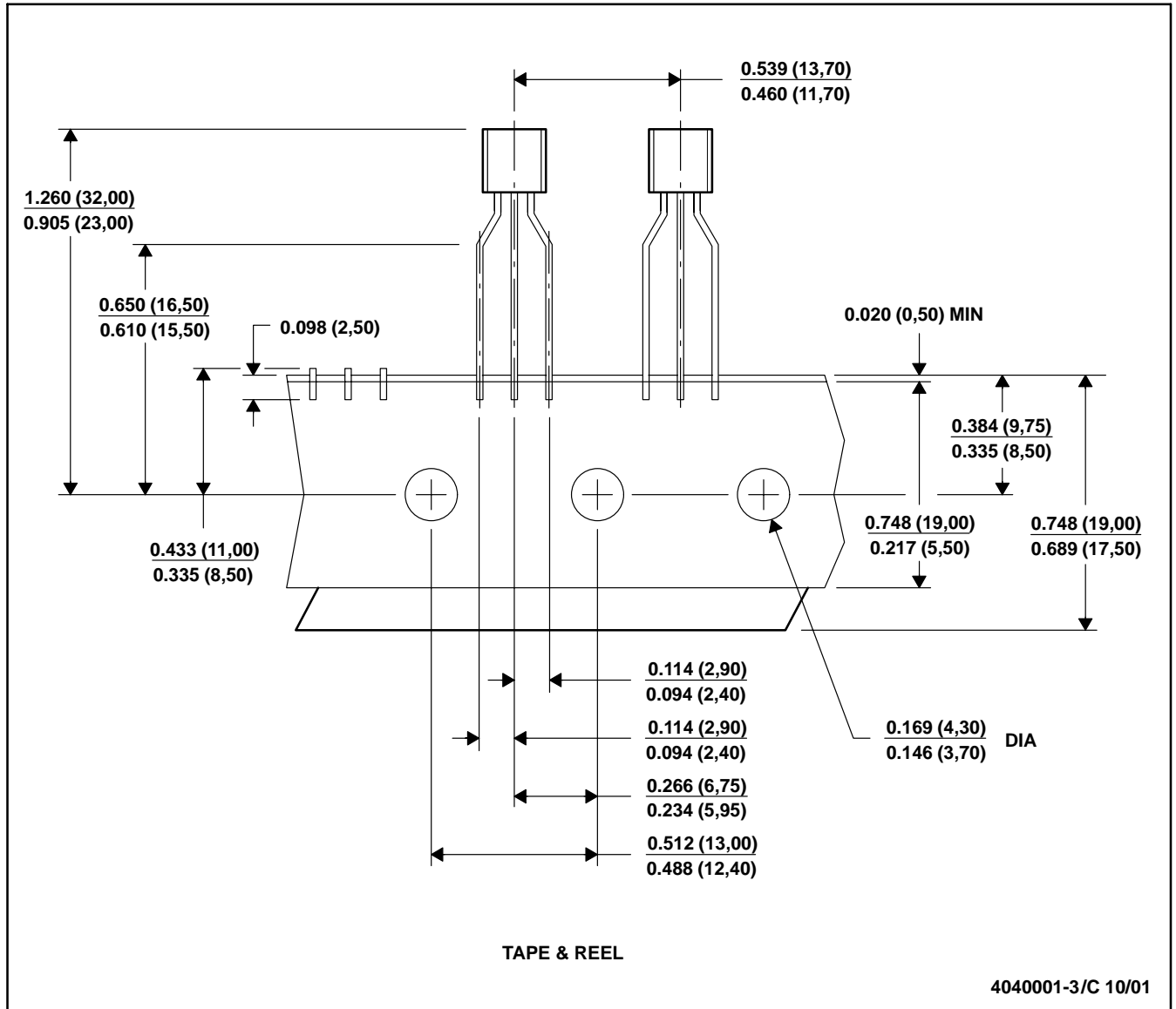

- NOTES: A. All linear dimensions are in inches (millimeters).
 B. This drawing is subject to change without notice.
 C. Tape and Reel information for the Format Lead Option package.

IMPORTANT NOTICE

Texas Instruments Incorporated and its subsidiaries (TI) reserve the right to make corrections, modifications, enhancements, improvements, and other changes to its products and services at any time and to discontinue any product or service without notice. Customers should obtain the latest relevant information before placing orders and should verify that such information is current and complete. All products are sold subject to TI's terms and conditions of sale supplied at the time of order acknowledgment.

TI warrants performance of its hardware products to the specifications applicable at the time of sale in accordance with TI's standard warranty. Testing and other quality control techniques are used to the extent TI deems necessary to support this warranty. Except where mandated by government requirements, testing of all parameters of each product is not necessarily performed.

TI assumes no liability for applications assistance or customer product design. Customers are responsible for their products and applications using TI components. To minimize the risks associated with customer products and applications, customers should provide adequate design and operating safeguards.

TI does not warrant or represent that any license, either express or implied, is granted under any TI patent right, copyright, mask work right, or other TI intellectual property right relating to any combination, machine, or process in which TI products or services are used. Information published by TI regarding third-party products or services does not constitute a license from TI to use such products or services or a warranty or endorsement thereof. Use of such information may require a license from a third party under the patents or other intellectual property of the third party, or a license from TI under the patents or other intellectual property of TI.

Reproduction of TI information in TI data books or data sheets is permissible only if reproduction is without alteration and is accompanied by all associated warranties, conditions, limitations, and notices. Reproduction of this information with alteration is an unfair and deceptive business practice. TI is not responsible or liable for such altered documentation. Information of third parties may be subject to additional restrictions.

Resale of TI products or services with statements different from or beyond the parameters stated by TI for that product or service voids all express and any implied warranties for the associated TI product or service and is an unfair and deceptive business practice. TI is not responsible or liable for any such statements.

TI products are not authorized for use in safety-critical applications (such as life support) where a failure of the TI product would reasonably be expected to cause severe personal injury or death, unless officers of the parties have executed an agreement specifically governing such use. Buyers represent that they have all necessary expertise in the safety and regulatory ramifications of their applications, and acknowledge and agree that they are solely responsible for all legal, regulatory and safety-related requirements concerning their products and any use of TI products in such safety-critical applications, notwithstanding any applications-related information or support that may be provided by TI. Further, Buyers must fully indemnify TI and its representatives against any damages arising out of the use of TI products in such safety-critical applications.

TI products are neither designed nor intended for use in military/aerospace applications or environments unless the TI products are specifically designated by TI as military-grade or "enhanced plastic." Only products designated by TI as military-grade meet military specifications. Buyers acknowledge and agree that any such use of TI products which TI has not designated as military-grade is solely at the Buyer's risk, and that they are solely responsible for compliance with all legal and regulatory requirements in connection with such use.

TI products are neither designed nor intended for use in automotive applications or environments unless the specific TI products are designated by TI as compliant with ISO/TS 16949 requirements. Buyers acknowledge and agree that, if they use any non-designated products in automotive applications, TI will not be responsible for any failure to meet such requirements.

Following are URLs where you can obtain information on other Texas Instruments products and application solutions:

| Products | | Applications | |
|-----------------------|--|---------------------|--|
| Amplifiers | amplifier.ti.com | Audio | www.ti.com/audio |
| Data Converters | dataconverter.ti.com | Automotive | www.ti.com/automotive |
| DSP | dsp.ti.com | Broadband | www.ti.com/broadband |
| Interface | interface.ti.com | Digital Control | www.ti.com/digitalcontrol |
| Logic | logic.ti.com | Military | www.ti.com/military |
| Power Mgmt | power.ti.com | Optical Networking | www.ti.com/opticalnetwork |
| Microcontrollers | microcontroller.ti.com | Security | www.ti.com/security |
| RFID | www.ti-rfid.com | Telephony | www.ti.com/telephony |
| Low Power Wireless | www.ti.com/lpw | Video & Imaging | www.ti.com/video |
| | | Wireless | www.ti.com/wireless |

Mailing Address: Texas Instruments, Post Office Box 655303, Dallas, Texas 75265
Copyright © 2007, Texas Instruments Incorporated