

PLEASE CHECK WWW.MOLEX.COM FOR LATEST PART INFORMATION

Part Number: [0879858050](#)
Status: **Active**
Description: 2.00mm (.079") Pitch Milli-Grid™ IDT Receptacle, Dual Row, with Center Polarization Key and Embossed Metal Latch, 50 Circuits, 0.38µm (15µ") Gold(Au) Plating on contact area, 1.88µm (74µ") Tin(Sn) Plating on IDT area, Lead free

Documents:

[3D Model](#) [Product Specification PS-87985-026 \(PDF\)](#)
[Drawing \(PDF\)](#) [RoHS Certificate of Compliance \(PDF\)](#)

General

Product Family	IDT and Solder Connectors
Series	87985
Crimp Quality Equipment	Yes
Product Name	Milli-Grid™
Use With	Stranded Flat Ribbon Cables

Physical

Circuits (Loaded)	50
Circuits (maximum)	50
Durability (mating cycles max)	500
Gender	Receptacle
Glow-Wire Compliant	No
Lock to Mating Part	Yes
Material - Metal	Beryllium Copper, Stainless Steel
Number of Rows	2
Packaging Type	Tray
Panel Mount	No
Pitch - Mating Interface (in)	0.079 In
Pitch - Mating Interface (mm)	2.00 mm
Pitch - Term. Interface (in)	0.079 In
Pitch - Term. Interface (mm)	2.00 mm
Polarized to Mating Part	Yes
Temperature Range - Operating	-40°C to +85°C
Wire Size AWG	26, 28

Electrical

Current - Maximum per Contact	1A
Voltage - Maximum	125V AC (RMS)/DC

Material Info

Reference - Drawing Numbers

Product Specification	PS-87985-026
Sales Drawing	SD-87985-015

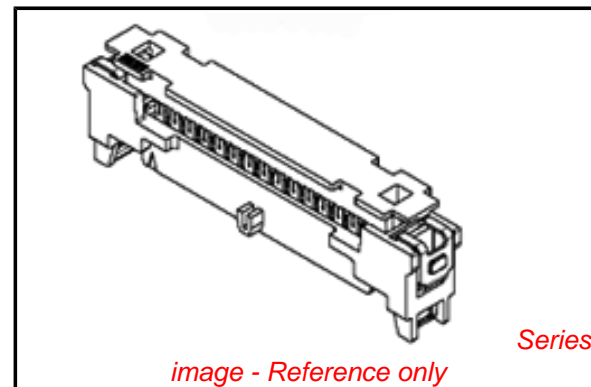

image - Reference only

EU RoHS

ELV and RoHS Compliant
REACH SVHC
 Not Reviewed
Halogen-Free
Status
Not Reviewed

China RoHS



Need more information on product environmental compliance?

Email productcompliance@molex.com
 For a multiple part number RoHS Certificate of Compliance, [click here](#)

Please visit the [Contact Us](#) section for any non-product compliance questions.

Search Parts in this Series

[87985Series](#)

Mates With

Milli-Grid(TM) Headers [87981](#) , [87982](#) , [87983](#) , [87984](#)

10 9 8 7 6 5 4 3 2 1

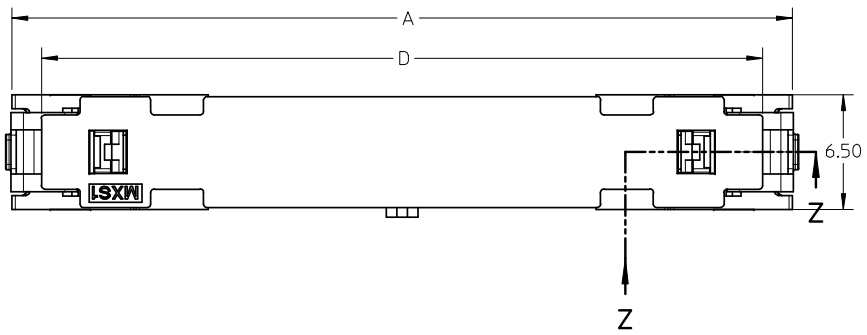

ASSEMBLY P/N	CKT SIZE	DIMENSION						
		A	B	C	D	E	F	G
87985-8030	30	44.25	28.00	42.65	40.90	30.55	28.70	22.00
87985-8040	40	54.25	38.00	52.65	50.90	40.55	38.70	32.00
87985-8044	44	58.25	42.00	56.65	54.90	44.55	42.70	36.00
87985-8050	50	64.25	48.00	62.65	60.90	50.55	48.70	42.00

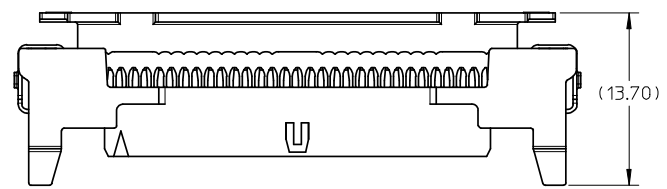

UPPER HOUSING IN OPEN POSITION

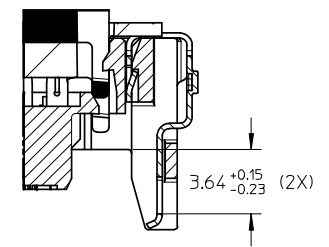
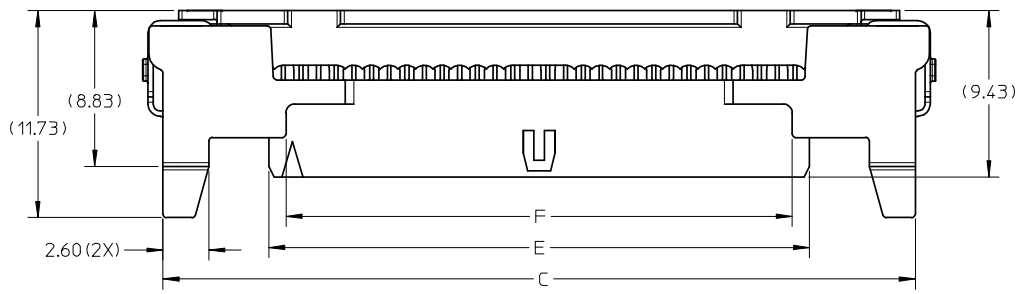

SECTION Z-Z

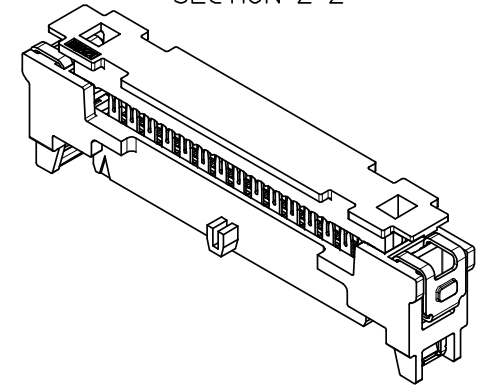
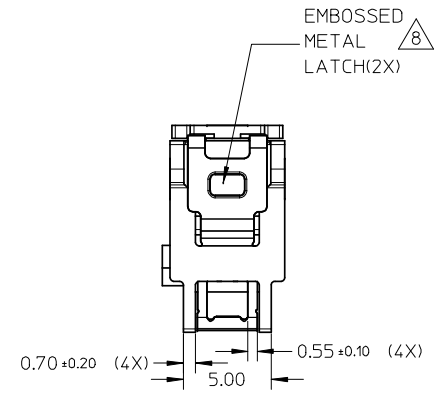
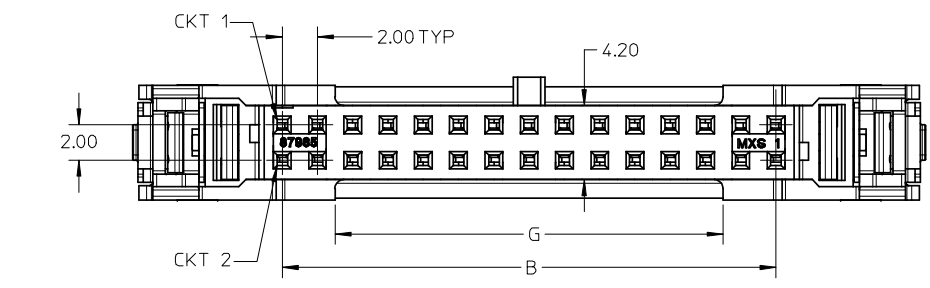

- NOTES:
- MATERIAL :
HOUSING : PBT, GLASS FILLED, UL94V-0, COLOR: GRAY,
UPPER HOUSING: PA66, GLASS FILLED, UL94V-0, COLOR: GRAY,
TERMINAL : COPPER ALLOY.
 - PLATING:
0.38µM GOLD IN CONTACT AREA AND 1.88µM TIN IN IDT
AREA OVER 1.25µM NICKEL OVERALL
 - FOR ILLUSTRATION PURPOSES, 30 CIRCUIT SIZE WAFER IS SHOWN.
 - THIS IS A LEAD FREE PRODUCT.
 - PRODUCT SPECIFICATION : PS-87985-026
 - PRODUCTS ARE PACKED IN TRAY.
 - PRODUCTS ARE MATED WITH 87981, 87982, 87983, 87984 SERIES.
 - LATCHES ARE NOT TO BE DEPRESSED DURING MATING.

REMOVE SERIES NO. EC NO: S2008-0476 DRWN: JTAN02 CHKD: BOKOK APPR: KCLING	2007/12/11 2007/12/11 2007/12/13	QUALITY SYMBOLS ▽=0 ◻=0	GENERAL TOLERANCES (UNLESS SPECIFIED)		DIMENSION STYLE MM ONLY		SCALE NTS	DESIGN UNITS METRIC	THIRD ANGLE PROJECTION		
				mm	INCH	DRAWN BY JTAN02	DATE 2006/11/21	TITLE MGRID, 2.00 IDT RECEPT. W/EMBOSSED METAL LATCH (W/O TRIANGLE PRINT)			
			4 PLACES	± ---	± ---	CHECKED BY BOKOK	DATE 2006/11/23	MOLEX INCORPORATED			
			3 PLACES	± ---	± ---	APPROVED BY PTLIM	DATE 2006/11/23	DOCUMENT NO. SD-87985-015			
			2 PLACES	± 0.2	± ---	MATERIAL NO. SEE TABLE		SHEET NO. 1 OF 1			
			1 PLACE	± ---	± ---	THIS DRAWING CONTAINS INFORMATION THAT IS PROPRIETARY TO MOLEX INCORPORATED AND SHOULD NOT BE USED WITHOUT WRITTEN PERMISSION					
DRAFT WHERE APPLICABLE MUST REMAIN WITHIN DIMENSIONS			ANGULAR ± 3 °								

9 8 7 6 5 4 3 2 1