



MCP1630/MCP1630V

High-Speed, Microcontroller-Adaptable, Pulse Width Modulator

Features

- High-Speed PWM Operation (12 ns Current Sense to Output Delay)
- Operating Temperature Range:
 - -40°C to +125°C
- Precise Peak Current Limit ($\pm 5\%$) (**MCP1630**)
- Voltage Mode and Average Current Mode Control (**MCP1630V**)
- CMOS Output Driver (drives MOSFET driver or low-side N-channel MOSFET directly)
- External Oscillator Input (from PICmicro[®] Microcontroller (MCU))
- External Voltage Reference Input (for adjustable voltage or current output application)
- Peak Current Mode Operation > 1 MHz
- Low Operating Current: 2.8 mA (typ.)
- Fast Output Rise and Fall Times: 5.9 ns and 6.2 ns
- Undervoltage Lockout (UVLO) Protection
- Output Short Circuit Protection
- Overtemperature Protection

Applications

- Intelligent Power Systems
- Smart Battery Charger Applications
- Multiple Output/Multiple Phase Converters
- Output Voltage Calibration
- AC Power Factor Correction
- VID Capability (programmed and calibrated by PICmicro[®] microcontroller)
- Buck/Boost/Buck-Boost/SEPIC/Flyback/Isolated Converters
- Parallel Power Supplies

Related Literature

- "MCP1630 NiMH Demo Board User's Guide", Microchip Technology Inc., DS51505, 2004
- "MCP1630 Low-Cost Li-Ion Battery Charger User's Guide", Microchip Technology Inc., DS51555, 2005
- "MCP1630 Li-Ion Multi-Bay Battery Charger User's Guide", Microchip Technology Inc., DS51515, 2005
- "MCP1630 Dual Buck Demo Board User's Guide", Microchip Technology Inc., DS51531, 2005

Description

The MCP1630/V is a high-speed Pulse Width Modulator (PWM) used to develop intelligent power systems. When used with a microcontroller unit (MCU), the MCP1630/V will control the power system duty cycle to provide output voltage or current regulation. The MCU can be used to adjust output voltage or current, switching frequency, maximum duty cycle and other features that make the power system more intelligent.

Typical applications include smart battery chargers, intelligent power systems, brick dc/dc converters, ac power-factor correction, multiple output power supplies, multi-phase power supplies and more.

The MCP1630/V inputs were developed to be easily attached to the I/O of a MCU. The MCU supplies the oscillator and reference to the MCP1630/V to provide the most flexible and adaptable power system. The power system switching frequency and maximum duty cycle are set using the I/O of the MCU. The reference input can be external, a D/A Converter (DAC) output or as simple as an I/O output from the MCU. This enables the power system to adapt to many external signals and variables in order to optimize performance and facilitate calibration.

When operating in Current mode, a precise limit is set on the peak current. With the fast comparator speed (typically 12 ns), the MCP1630 is capable of providing a tight limit on the maximum switch current over a wide input voltage range when compared to other high-speed PWM controllers.

For Voltage mode or Average Current mode applications, the MCP1630V provides a larger range for the external ramp voltage.

Additional protection features include: UVLO, overtemperature and overcurrent.

Package Type

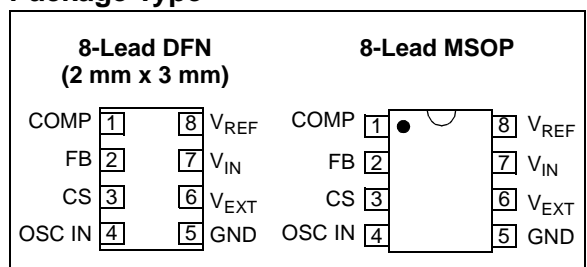

MCP1630/MCP1630V

Functional Block Diagram – MCP1630

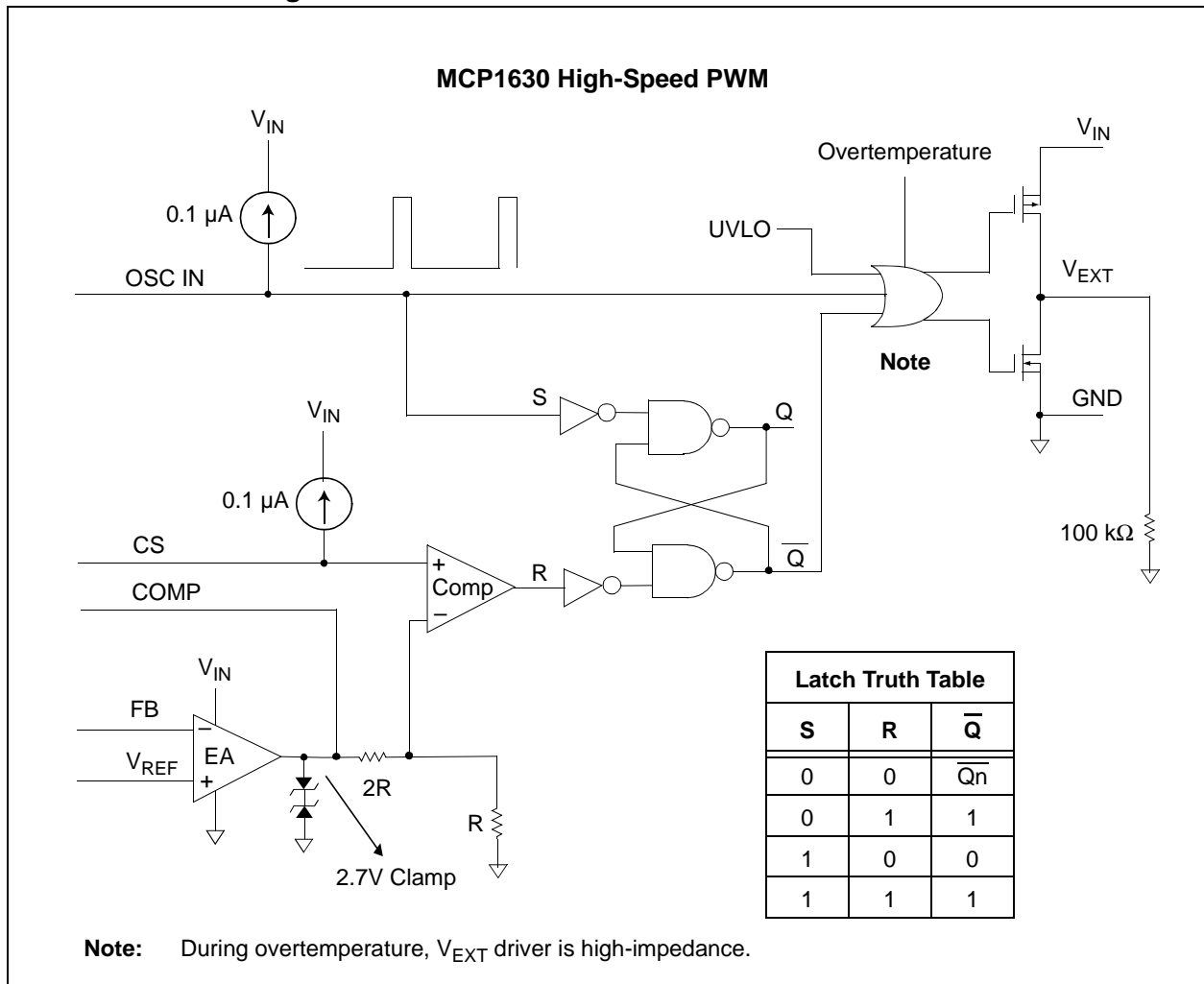

MCP1630/MCP1630V

Functional Block Diagram – MCP1630V

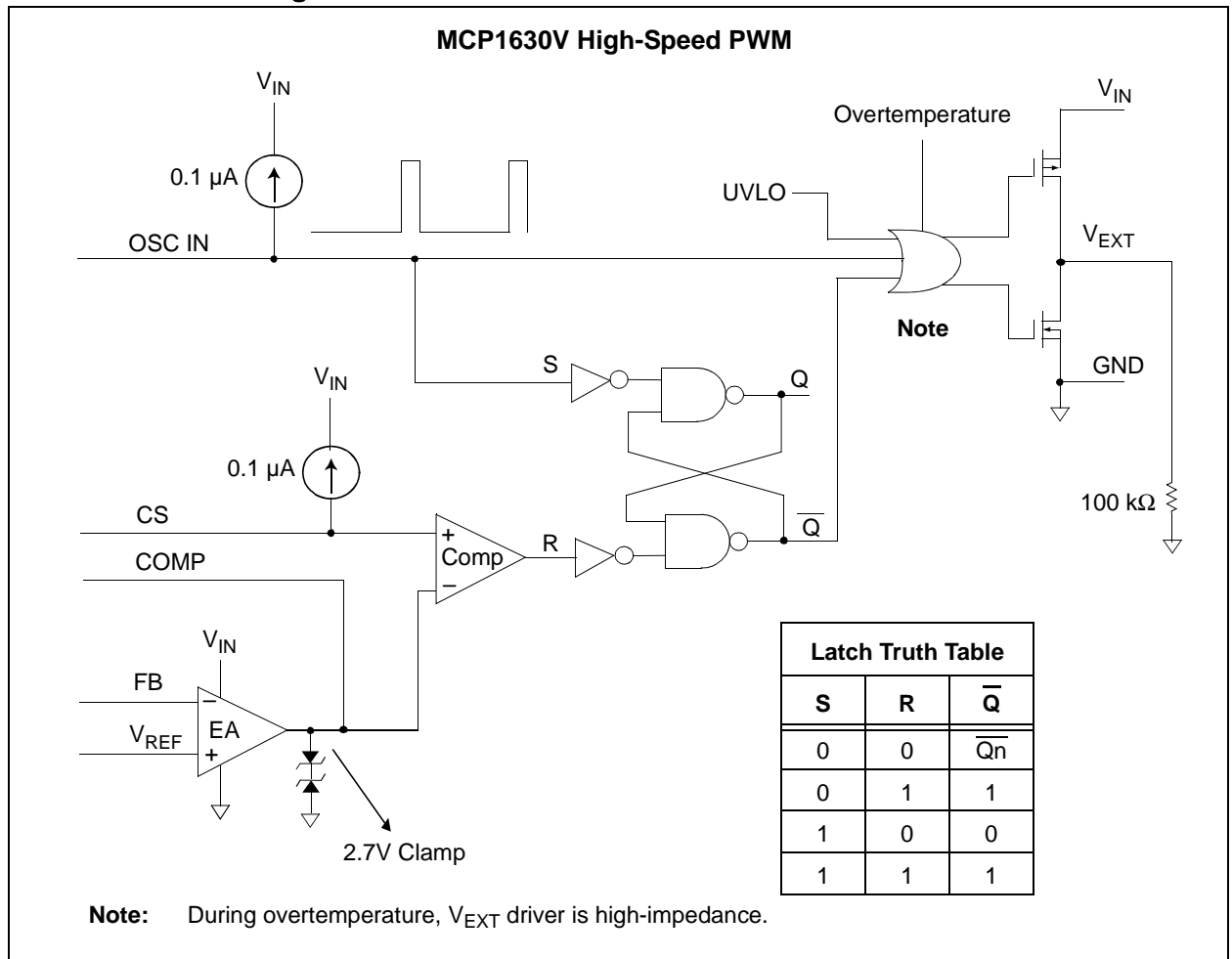

MCP1630/MCP1630V

Typical Application Circuit - MCP1630V

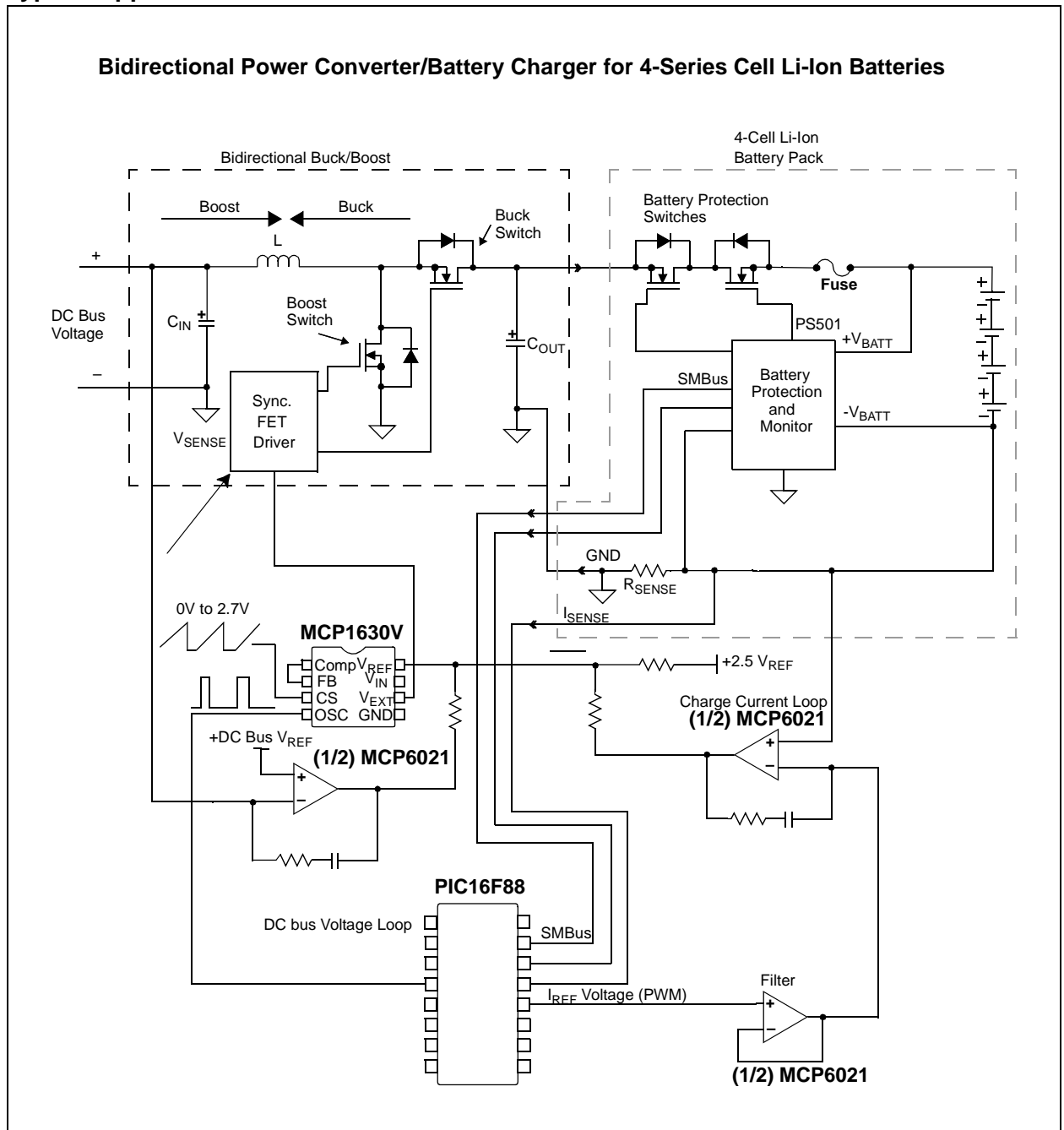

MCP1630/MCP1630V

1.0 ELECTRICAL CHARACTERISTICS

Absolute Maximum Ratings †

V _{DD}	6.0V
Maximum Voltage on Any Pin ..(V _{GND} - 0.3)V to (V _{IN} + 0.3)V	
V _{EXT} Short Circuit Current	Internally Limited
Storage temperature	-65°C to +150°C
Maximum Junction Temperature, T _J	+150°C
Continuous Operating Temperature Range ..-	-40°C to +125°C
ESD protection on all pins, HBM.....	3 kV

† **Notice:** Stresses above those listed under "Maximum Ratings" may cause permanent damage to the device. This is a stress rating only and functional operation of the device at those or any other conditions above those indicated in the operational listings of this specification is not implied. Exposure to maximum rating conditions for extended periods may affect device reliability.

AC/DC CHARACTERISTICS

Electrical Specifications: Unless otherwise noted, V _{IN} = 3.0V to 5.5V, F _{OSC} = 1 MHz with 10% Duty Cycle, C _{IN} = 0.1 μF, V _{IN} for typical values = 5.0V, T _A = -40°C to +125°C.						
Parameters	Sym	Min	Typ	Max	Units	Conditions
Input Voltage						
Input Operating Voltage	V _{IN}	3.0	—	5.5	V	
Input Quiescent Current	I(V _{IN})	—	2.8	4.5	mA	I _{EXT} = 0 mA, F _{OSC IN} = 0 Hz
Oscillator Input						
External Oscillator Range	F _{OSC}	—	—	1	MHz	Note 1
Min. Oscillator High Time	T _{OH_MIN}	—	10		ns	
Min. Oscillator Low Time	T _{OL_MIN}	—	10		ns	
Oscillator Rise Time	T _{RISE}	0.01	—	10	μs	Note 2
Oscillator Fall Time	T _{FALL}	0.01	—	10	μs	Note 2
Oscillator Input Voltage Low	V _L	—	—	0.8	V	
Oscillator Input Voltage High	V _H	2.0	—	—	V	
Oscillator Input Capacitance	C _{OSC}		5		pf	
External Reference Input						
Reference Voltage Input	V _{REF}	0	—	V _{IN}	V	Note 2, Note 3
Error Amplifier						
Input Offset Voltage	V _{OS}	-4	0.1	+4	mV	
Error Amplifier PSRR	PSRR	80	99	—	dB	V _{IN} = 3.0V to 5.0V, V _{CM} = 1.2V
Common Mode Input Range	V _{CM}	GND - 0.3	—	V _{IN}	V	Note 2, Note 3
Common Mode Rejection Ratio		—	80	—	dB	V _{IN} = 5V, V _{CM} = 0V to 2.5V
Open-loop Voltage Gain	A _{VOL}	85	95	—	dB	R _L = 5 kΩ to V _{IN} /2, 100 mV < V _{EAOUT} < V _{IN} - 100 mV, V _{CM} = 1.2V
Low-level Output	V _{OL}	—	25	GND + 50	mV	R _L = 5 kΩ to V _{IN} /2
Gain Bandwidth Product	GBWP	—	3.5	—	MHz	V _{IN} = 5V
Error Amplifier Sink Current	I _{SINK}	5	11	—	mA	V _{IN} = 5V, V _{REF} = 1.2V, V _{FB} = 1.4V, V _{COMP} = 2.0V
Error Amplifier Source Current	I _{SOURCE}	-2	-9	—	mA	V _{IN} = 5V, V _{REF} = 1.2V, V _{FB} = 1.0V, V _{COMP} = 2.0V, Absolute Value

- Note 1:** Capable of higher frequency operation depending on minimum and maximum duty cycles needed.
- Note 2:** External oscillator input (OSC IN) rise and fall times between 10 ns and 10 μs used for characterization testing. Signal levels between 0.8V and 2.0V with rise and fall times measured between 10% and 90% of maximum and minimum values. Not production tested.
- Note 3:** The reference input of the internal amplifier is capable of rail-to-rail operation.

MCP1630/MCP1630V

AC/DC CHARACTERISTICS (CONTINUED)

Electrical Specifications: Unless otherwise noted, $V_{IN} = 3.0V$ to $5.5V$, $F_{OSC} = 1$ MHz with 10% Duty Cycle, $C_{IN} = 0.1 \mu F$, V_{IN} for typical values = $5.0V$, $T_A = -40^\circ C$ to $+125^\circ C$.						
Parameters	Sym	Min	Typ	Max	Units	Conditions
Current Sense Input						
Maximum Current Sense Signal MCP1630	V_{CS_MAX}	0.85	0.9	0.95	V	Set by maximum error amplifier clamp voltage, divided by 3.
Delay From CS to V_{EXT} MCP1630	T_{CS_VEXT}	—	12	25	ns	
Maximum Current Sense Signal MCP1630V	V_{CS_MAX}	2.55	2.7	2.85	V	$V_{IN} > 4.25V$ Maximum CS input range limited by comparator input common mode range. $V_{CS_MAX} = V_{IN} - 1.4V$
Delay From CS to V_{EXT} MCP1630V	T_{CS_VEXT}	—	17.5	35	ns	
Minimum Duty Cycle	DC_{MIN}	—	—	0	%	$V_{FB} = V_{REF} + 0.1V$, $V_{CS} = GND$
Current Sense Input Bias Current	I_{CS_B}	—	-0.1	—	μA	$V_{IN} = 5V$
Internal Driver						
R_{DSon} P-channel	R_{DSon_P}	—	10	30	Ω	
R_{DSon} N-channel	R_{DSon_N}	—	7	30	Ω	
V_{EXT} Rise Time	T_{RISE}	—	5.9	18	ns	$C_L = 100$ pF Typical for $V_{IN} = 3V$
V_{EXT} Fall Time	T_{FALL}	—	6.2	18	ns	$C_L = 100$ pF Typical for $V_{IN} = 3V$
Protection Features						
Under Voltage Lockout	UVLO	2.7	—	3.0	V	V_{IN} falling, V_{EXT} low state when in UVLO
Under Voltage Lockout Hysteresis	$UVLO_{HYS}$	50	75	150	mV	
Thermal Shutdown	T_{SHD}	—	150	—	$^\circ C$	
Thermal Shutdown Hysteresis	T_{SHD_HYS}	—	18	—	$^\circ C$	

- Note 1:** Capable of higher frequency operation depending on minimum and maximum duty cycles needed.
- Note 2:** External oscillator input (OSC IN) rise and fall times between 10 ns and 10 μs used for characterization testing. Signal levels between 0.8V and 2.0V with rise and fall times measured between 10% and 90% of maximum and minimum values. Not production tested.
- Note 3:** The reference input of the internal amplifier is capable of rail-to-rail operation.

TEMPERATURE SPECIFICATIONS

Electrical Specifications: $V_{IN} = 3.0V$ to $5.5V$, $F_{OSC} = 1$ MHz with 10% Duty Cycle, $C_{IN} = 0.1 \mu F$, $T_A = -40^\circ C$ to $+125^\circ C$.						
Parameters	Sym	Min	Typ	Max	Units	Conditions
Temperature Ranges						
Operating Junction Temperature Range	T_A	-40	—	+125	$^\circ C$	Steady state
Storage Temperature Range	T_A	-65	—	+150	$^\circ C$	
Maximum Junction Temperature	T_J	—	—	+150	$^\circ C$	Transient
Thermal Package Resistances						
Thermal Resistance, 8L-DFN (2 mm x 3 mm)	θ_{JA}	—	50.8	—	$^\circ C/W$	Typical 4-layer board with two interconnecting vias
Thermal Resistance, 8L-MSOP	θ_{JA}	—	208	—	$^\circ C/W$	Typical 4-layer board

MCP1630/MCP1630V

2.0 TYPICAL PERFORMANCE CURVES

Note: The graphs and tables provided following this note are a statistical summary based on a limited number of samples and are provided for informational purposes only. The performance characteristics listed herein are not tested or guaranteed. In some graphs or tables, the data presented may be outside the specified operating range (e.g., outside specified power supply range) and therefore outside the warranted range.

Note: Unless otherwise noted, $V_{IN} = 3.0V$ to $5.5V$, $F_{OSC} = 1\text{ MHz}$ with 10% Duty Cycle, $C_{IN} = 0.1\ \mu F$, V_{IN} for typical values = $5.0V$, $T_A = -40^\circ C$ to $+125^\circ C$.

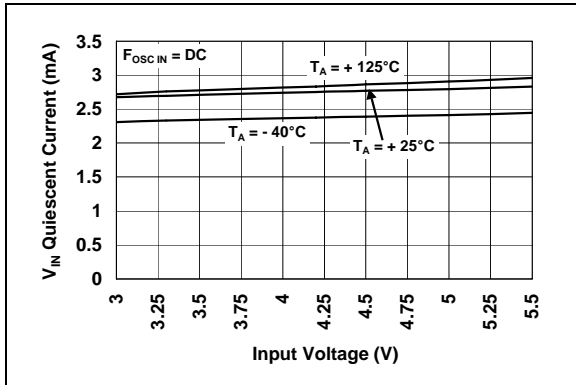

FIGURE 2-1: Input Quiescent Current vs. Input Voltage.

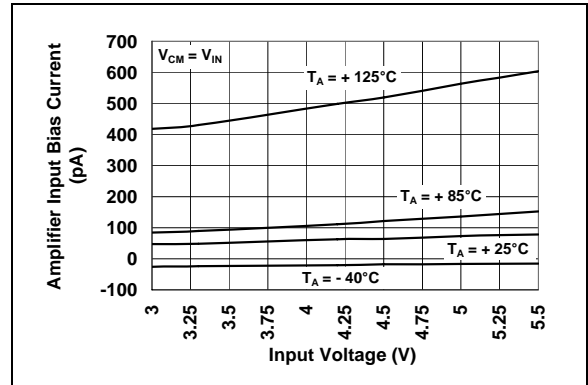

FIGURE 2-4: Error Amplifier Input Bias Current vs. Input Voltage.

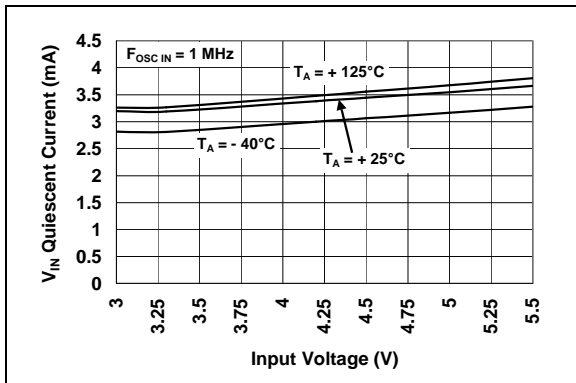

FIGURE 2-2: Input Quiescent Current vs. Input Voltage.

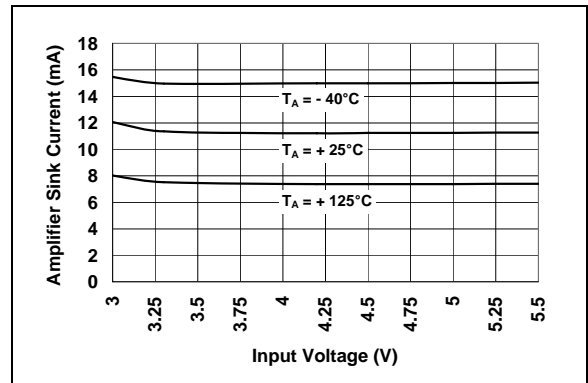

FIGURE 2-5: Error Amplifier Sink Current vs. Input Voltage.

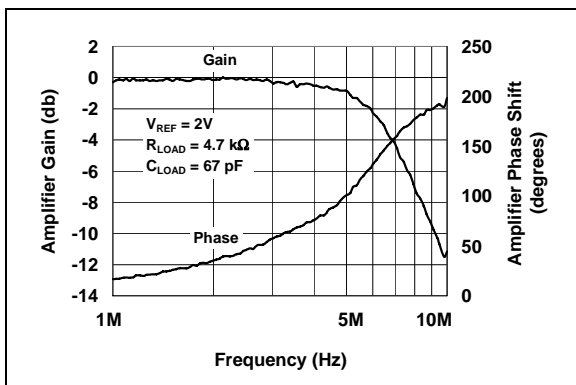

FIGURE 2-3: Error Amplifier Frequency Response.

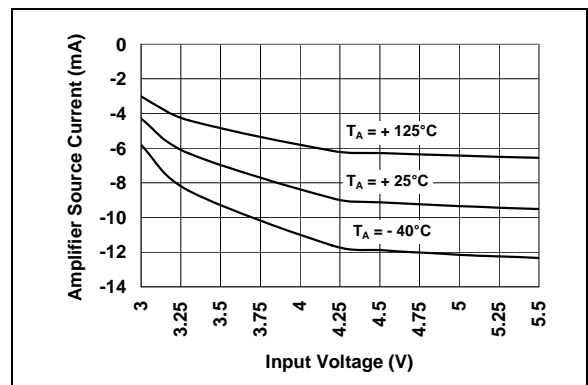

FIGURE 2-6: Error Amplifier Source Current vs. Input Voltage.

MCP1630/MCP1630V

Note: Unless otherwise noted, $V_{IN} = 3.0V$ to $5.5V$, $F_{OSC} = 1$ MHz with 10% Duty Cycle, $C_{IN} = 0.1 \mu F$, V_{IN} for typical values = $5.0V$, $T_A = -40^\circ C$ to $+125^\circ C$.

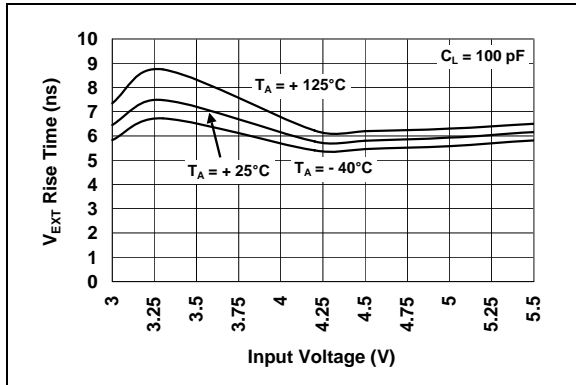

FIGURE 2-7: V_{EXT} Rise Time vs. Input Voltage.

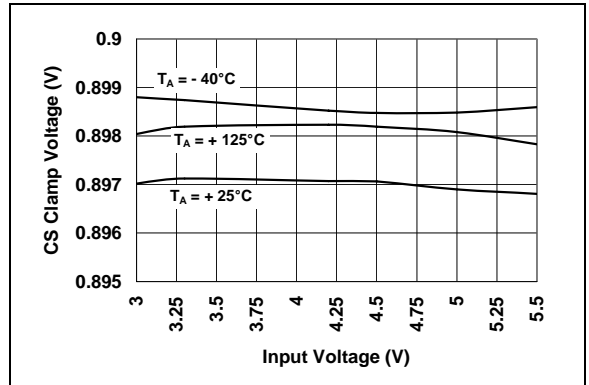

FIGURE 2-10: Current Sense Clamp Voltage vs. Input Voltage (MCP1630).

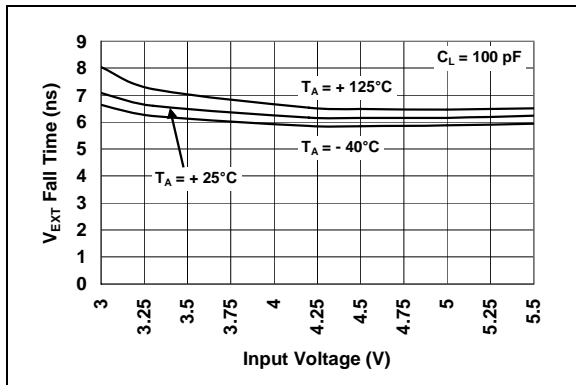

FIGURE 2-8: V_{EXT} Fall Time vs. Input Voltage.

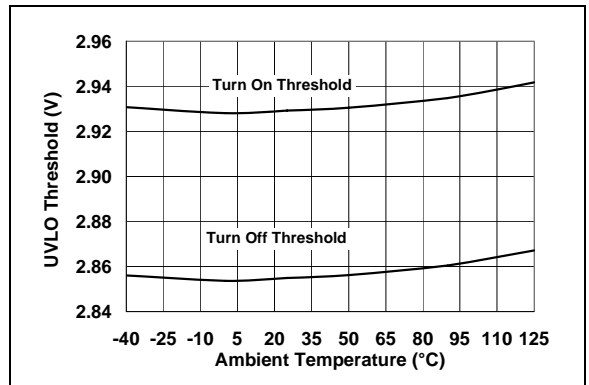

FIGURE 2-11: Undervoltage Lockout vs. Temperature.

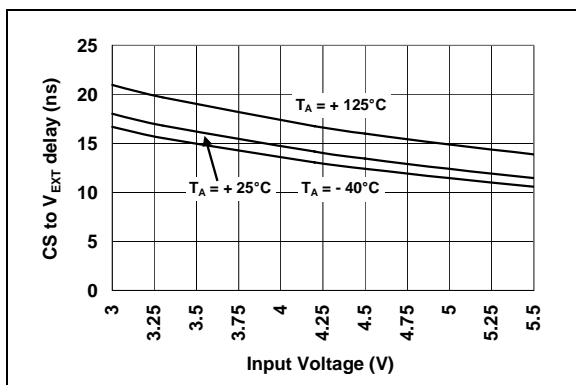

FIGURE 2-9: Current Sense to V_{EXT} Delay vs. Input Voltage (MCP1630).

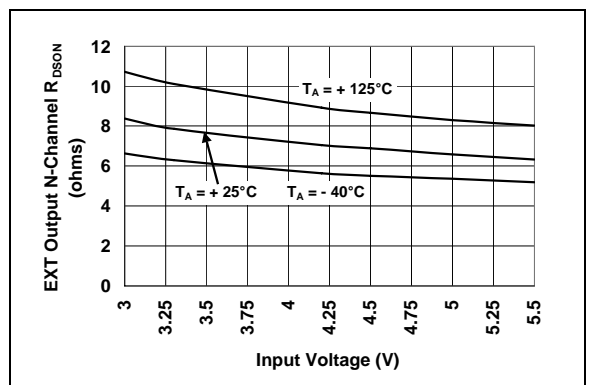

FIGURE 2-12: EXT Output N-channel $R_{DS(on)}$ vs. Input Voltage.

MCP1630/MCP1630V

Note: Unless otherwise noted, $V_{IN} = 3.0V$ to $5.5V$, $F_{OSC} = 1$ MHz with 10% Duty Cycle, $C_{IN} = 0.1$ μF , V_{IN} for typical values = $5.0V$, $T_A = -40^\circ C$ to $+125^\circ C$.

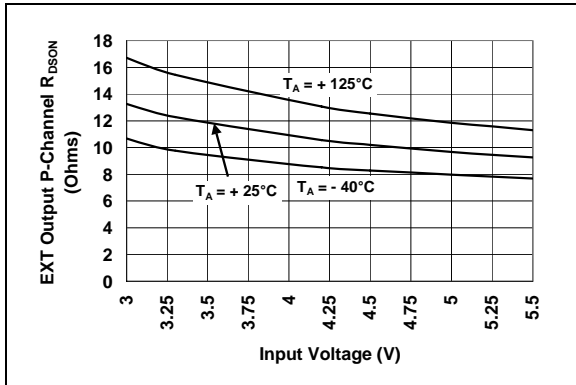

FIGURE 2-13: EXT Output P-channel R_{DSON} vs. Input Voltage.

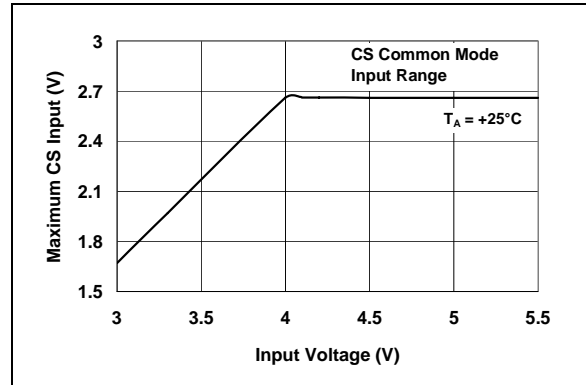

FIGURE 2-16: Current Sense Common Mode Input Voltage Range vs. Input Voltage (MCP1630V).

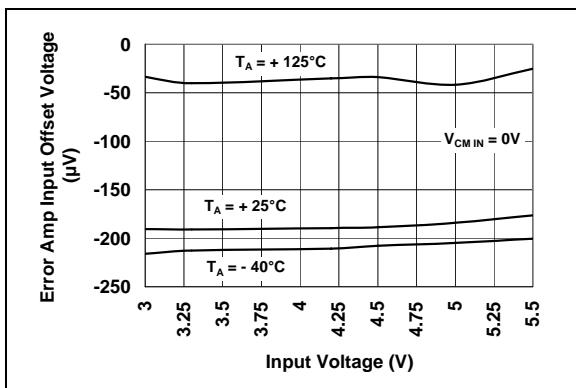

FIGURE 2-14: Error Amplifier Input Offset Voltage vs. Input Voltage.

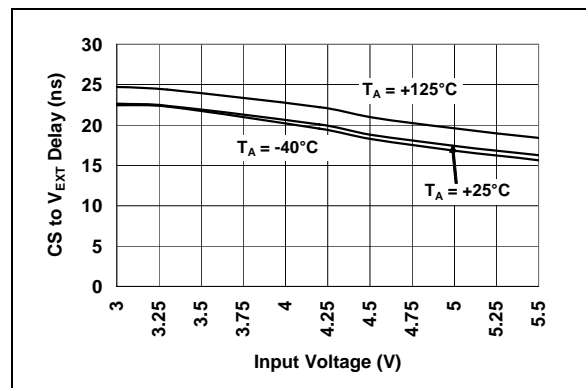

FIGURE 2-17: Current Sense to V_{EXT} Delay vs. Input Voltage (MCP1630V).

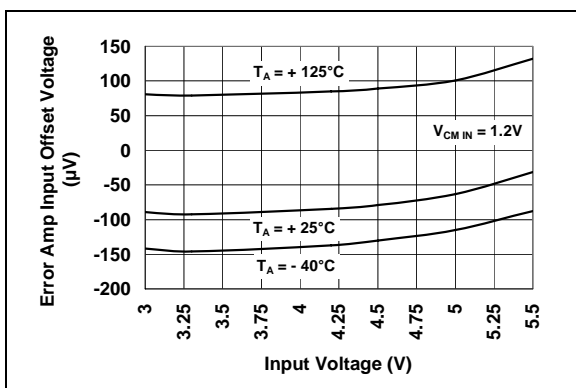

FIGURE 2-15: Error Amplifier Input Offset Voltage vs. Input Voltage.

MCP1630/MCP1630V

3.0 MCP1630 PIN DESCRIPTIONS

The descriptions of the pins are listed in Table 3-1.

TABLE 3-1: PIN FUNCTION TABLE

DFN/MSOP	Name	Function
1	COMP	Error Amplifier Output pin
2	FB	Error Amplifier Inverting Input
3	CS	Current Sense Input pin (MCP1630) or Voltage Ramp Input pin (MCP1630V)
4	OSC IN	Oscillator Input pin
5	GND	Circuit Ground pin
6	V _{EXT}	External Driver Output pin
7	V _{IN}	Input Bias pin
8	V _{REF}	Reference Voltage Input pin

3.1 Error Amplifier Output Pin (COMP)

COMP is an internal error amplifier output pin. External compensation is connected from the FB pin to the COMP pin for control-loop stabilization. An internal voltage clamp is used to limit the maximum COMP pin voltage to 2.7V (typ.). This clamp is used to set the maximum peak current in the power system switch by setting a maximum limit on the CS input for Peak Current mode control systems.

3.2 Error Amplifier Inverting Input (FB)

FB is an internal error amplifier inverting input pin. The output (voltage or current) is sensed and fed back to the FB pin for regulation. Inverting or negative feedback is used.

3.3 Current Sensing Input (CS)

CS is the current sense input pin used for cycle-by-cycle control for Peak Current mode converters. The MCP1630 is typically used for sensed current applications to reduce the current sense signal, thus reducing power dissipation.

For Voltage mode or Average Current mode applications, a ramp is used to compare the error amplifier output voltage with producing the PWM duty cycle. For applications that require higher signal levels, the MCP1630V is used to increase the level from a maximum of 0.9V (MCP1630) to 2.7V (MCP1630V). The common mode voltage range for the MCP1630V CS input is V_{IN}-1.4V. For normal PWM operation, the CS input should be less than or equal to V_{IN} - 1.4V at all times.

3.4 Oscillator Input (OSC)

OSC is an external oscillator input pin. Typically, a microcontroller I/O pin is used to generate the OSC input. When high, the output driver pin (V_{EXT}) is driven

low. The high-to-low transition initiates the start of a new cycle. The duty cycle of the OSC input pin determines the maximum duty cycle of the power converter. For example, if the OSC input is low for 75% of the time and high for 25% of the time, the duty cycle range for the power converter is 0% to 75% maximum.

3.5 Ground (GND)

Connect the circuit ground to the GND pin. For most applications, this should be connected to the analog or quiet ground plane. Noise on this ground can affect the sensitive cycle-by-cycle comparison between the CS input and the error amplifier output.

3.6 External Driver Output Pin (V_{EXT})

V_{EXT} is an external driver output pin, used to determine the power system duty cycle. For high-power or high-side drives, this output should be connected to the logic-level input of the MOSFET driver. For low-power, low-side applications, the V_{EXT} pin can be used to directly drive the gate of an N-channel MOSFET.

3.7 Input Bias Pin (V_{IN})

V_{IN} is an input voltage pin. Connect the input voltage source to the V_{IN} pin. For normal operation, the voltage on the V_{IN} pin should be between +3.0V and +5.5V. A 0.1 μF bypass capacitor should be connected between the V_{IN} pin and the GND pin.

3.8 Reference Voltage Input (V_{REF})

V_{REF} is an external reference input pin used to regulate the output of the power system. By changing the V_{REF} input, the output (voltage or current) of the power system can be changed. The reference voltage can range from 0V to V_{IN} (rail-to-rail).

MCP1630/MCP1630V

4.0 DETAILED DESCRIPTION

4.1 Device Overview

The MCP1630 is comprised of a high-speed comparator, high-bandwidth amplifier and logic gates that can be combined with a PICmicro MCU to develop an advanced programmable power supply. The oscillator and reference voltage inputs are generated by the PICmicro MCU so that switching frequency, maximum duty cycle and output voltage are programmable. Refer to Figure 4-1.

4.2 PWM

The V_{EXT} output of the MCP1630/V is determined by the output level of the internal high-speed comparator and the level of the external oscillator. When the oscillator level is high, the PWM output (V_{EXT}) is forced low. When the external oscillator is low, the PWM output is determined by the output level of the internal high-speed comparator. During UVLO, the V_{EXT} pin is held in the low state. During overtemperature operation, the V_{EXT} pin is high-impedance (100 k Ω to ground).

4.3 Normal Cycle by Cycle Control

The beginning of a cycle is defined when OSC IN transitions from a high state to a low state. For normal operation, the state of the high-speed comparator output (R) is low and the \bar{Q} output of the latch is low. On the OSC IN high-to-low transition, the S and R inputs to the high-speed latch are both low and the \bar{Q} output will remain unchanged (low). The output of the OR gate (V_{DRIVE}) will transition from a high state to a low state, turning on the internal P-channel drive transistor in the output stage of the PWM. This will change the PWM output (V_{EXT}) from a low state to a high state, turning on the power-train external switch and ramping current in the power-train magnetic device.

The sensed current in the magnetic device is fed into the CS input (shown as a ramp) and increases linearly. Once the sensed current ramp (MCP1630) reaches the same voltage level as 1/3 of the EA output, the comparator output (R) changes states (low-to-high) and resets the PWM latch. The \bar{Q} output transitions from a low state to a high state, turning on the N-channel MOSFET in the output stage, which turns off the V_{EXT} drive to the external MOSFET driver terminating the duty cycle. The OSC IN will transition from a low state to a high state while the V_{EXT} pin remains unchanged. If the CS input ramp had never reached the same level as 1/3 of the error amplifier output, the low-to-high transition on OSC IN would terminate the duty cycle and this would be considered maximum duty cycle. In either case, while OSC IN is high, the V_{EXT} drive pin is low, turning off the external power-train switch. The next cycle will start on the transition of the OSC IN pin from a high state to a low state.

For Voltage mode or Average Current mode applications that utilize a large signal ramp at the CS input, the MCP1630V is used to provide more signal (2.7V typ.). The operation of the PWM does not change.

4.4 Error Amp/Comparator Current Limit Function

The internal amplifier is used to create an error output signal that is determined by the external V_{REF} input and the power supply output fed back into the FB pin. The error amplifier output is rail-to-rail and clamped by a precision 2.7V. The output of the error amplifier is then divided down 3:1 (MCP1630) and connected to the inverting input of the high-speed comparator. Since the maximum output of the error amplifier is 2.7V, the maximum input to the inverting pin of the high-speed comparator is 0.9V. This sets the peak current limit for the switching power supply.

For the MCP1630V, the maximum error amplifier output is still 2.7V. However, the resistor divider is removed, raising the maximum input signal level at the high-speed comparator inverting input (CS) to 2.7V.

As the output load current demand increases, the error amplifier output increases, causing the inverting input pin of the high-speed comparator to increase. Eventually, the output of the error amplifier will hit the 2.7V clamp, limiting the input of the high-speed comparator to 0.9V max (MCP1630). Even if the FB input continues to decrease (calling for more current), the inverting input is limited to 0.9V. By limiting the inverting input to 0.9V, the current-sense input (CS) is limited to 0.9V, thus limiting the output current of the power supply.

For Voltage mode control, the error amplifier output will increase as input voltage decreases. A voltage ramp is used instead of sensed inductor current at the CS input of the MCP1630V. The 3:1 internal error amplifier output resistor divider is removed in the MCP1630V option to increase the maximum signal level input to 2.7V (typ.).

4.5 0% Duty Cycle Operation

The duty cycle of the V_{EXT} output is capable of reaching 0% when the FB pin is held higher than the V_{REF} pin (inverting error amplifier). This is accomplished by the rail-to-rail output capability of the error amplifier and the offset voltage of the high-speed comparator. The minimum error amplifier output voltage, divided by three, is less than the offset voltage of the high-speed comparator. In the case where the output voltage of the converter is above the desired regulation point, the FB input will be above the V_{REF} input and the error amplifier will be pulled to the bottom rail (GND). This low voltage is divided down 3:1 by the 2R and 1R resistor (MCP1630) and connected to the input of the high-speed comparator. This voltage will be low enough so that there is no triggering of the comparator, allowing narrow pulse widths at V_{EXT} .

4.6 Undervoltage Lockout (UVLO)

When the input voltage (V_{IN}) is less than the UVLO threshold, the V_{EXT} is held in the low state. This will ensure that, if the voltage is not adequate to operate the MCP1630/V, the main power supply switch will be held in the off state. When the UVLO threshold is exceeded, there is some hysteresis in the input voltage prior to the UVLO off threshold being reached. The typical hysteresis is 75 mV. Typically, the MCP1630 will not start operating until the input voltage at V_{IN} is between 3.0V and 3.1V.

4.7 Overtemperature Protection

To protect the V_{EXT} output if shorted to V_{IN} or GND, the MCP1630/V V_{EXT} output will be high-impedance if the junction temperature is above the thermal shutdown threshold. There is an internal 100 k Ω pull-down resistor connected from V_{EXT} to ground to provide some pull-down during overtemperature conditions. The protection is set to 150°C (typ.), with a hysteresis of 18°C.

MCP1630/MCP1630V

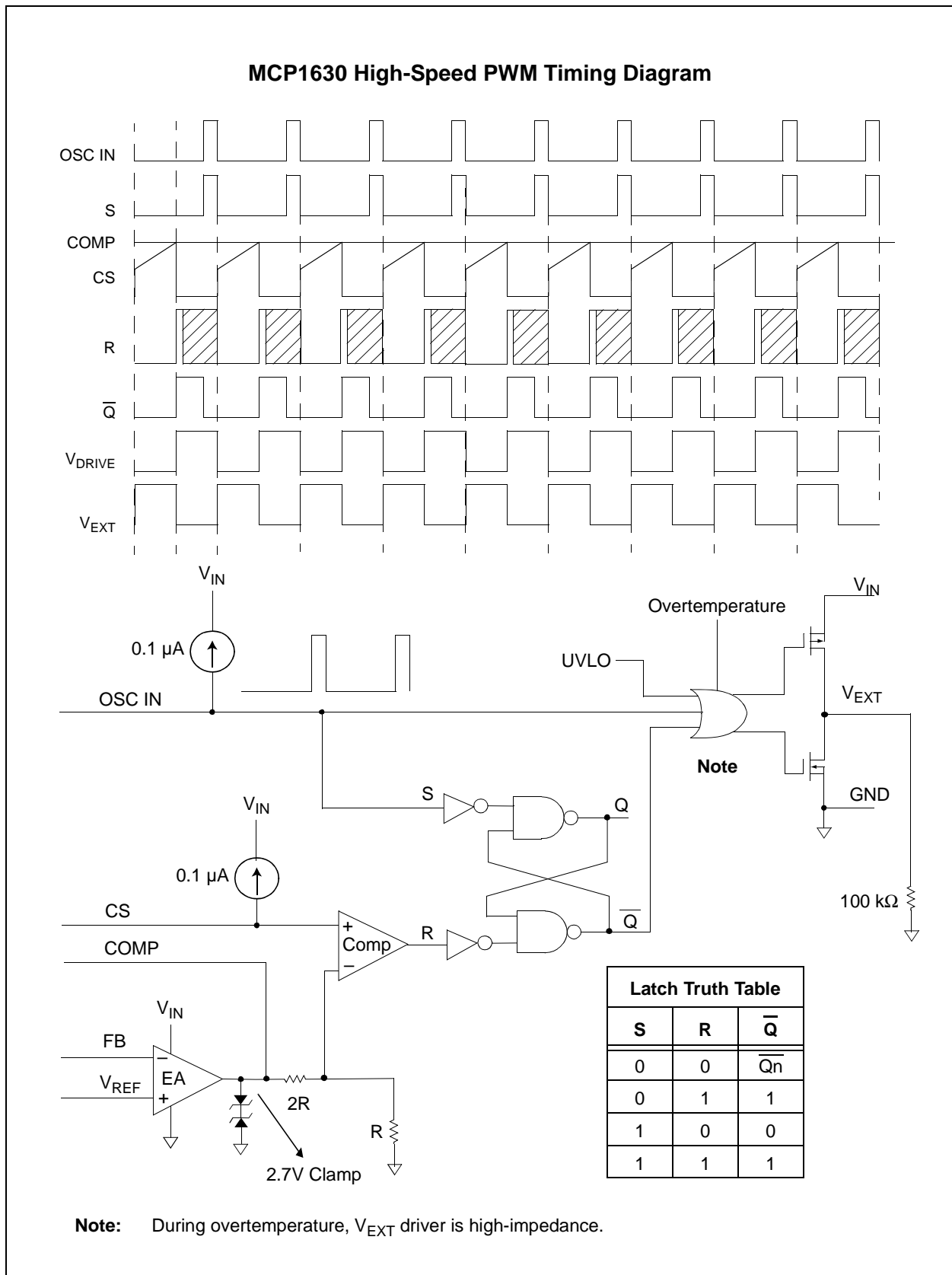

FIGURE 4-1: Cycle-by-Cycle Timing Diagram (MCP1630).

MCP1630/MCP1630V

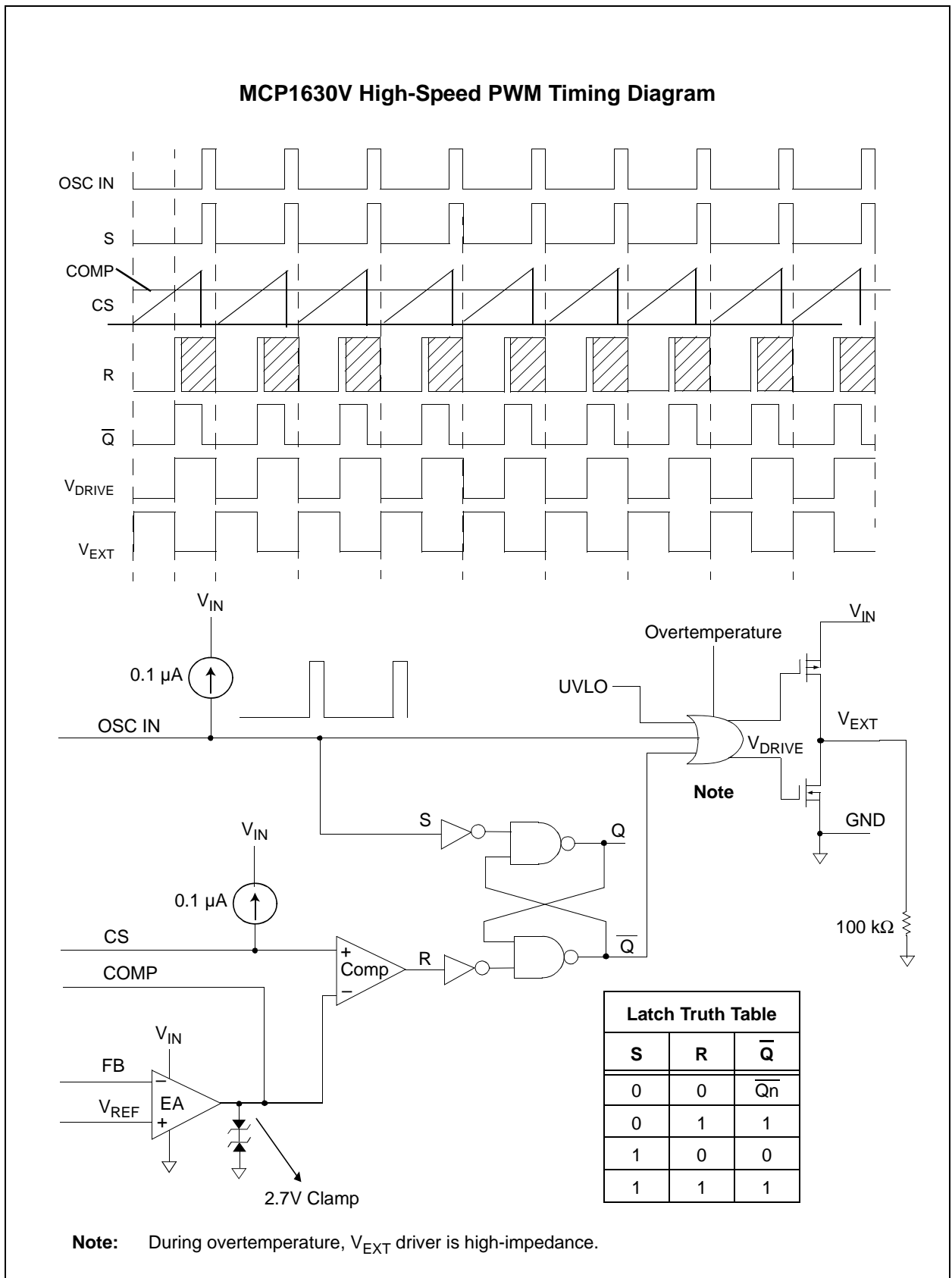

FIGURE 4-2: Cycle-by-Cycle Timing Diagram (MCP1630V).

MCP1630/MCP1630V

5.0 APPLICATION CIRCUITS/ISSUES

5.1 Typical Applications

The MCP1630/V high-speed PWM can be used for any circuit topology and power-train application when combined with a microcontroller. Intelligent, cost-effective power systems can be developed for applications that require multiple outputs, multiple phases, adjustable outputs, temperature monitoring and calibration.

5.2 NiMH Battery Charger Application

A typical NiMH battery charger application is shown in the “**Typical Application Circuit – MCP1630**” of this data sheet. In that example, a Single-Ended Primary Inductive Converter (SEPIC) is used to provide a constant charge current to the series-connected batteries. The MCP1630 is used to regulate the charge current by monitoring the current through the battery sense resistor and providing the proper pulse width.

The PIC16F818 monitors the battery voltage to provide a termination to the charge current. Additional features (trickle charge, fast charge, overvoltage protection, etc.) can be added to the system using the programmability of the microcontroller and the flexibility of the MCP1630.

5.3 Bidirectional Power Converter

A bidirectional Li-Ion charger/buck regulator is shown in the “**Typical Application Circuit**” of the this data sheet. In this example, a synchronous, bidirectional power converter example is shown using the MCP1630V. In this application, when the ac-dc input power is present, the bidirectional power converter is used to charge 4-series Li-Ion batteries by boosting the input voltage. When ac-dc power is removed, the bidirectional power converter bucks the battery voltage down to provide a dc bus for system power. By using this method, a single power train is capable of charging 4-series cell Li-Ion batteries and efficiently converting the battery voltage down to a low, usable voltage.

5.4 Multiple Output Converters

By using additional MCP1630 devices, multiple output converters can be developed using a single MCU. If a two-output converter is desired, the MCU can provide two PWM outputs that are phased 180° apart. This will reduce the input ripple current to the source and eliminate beat frequencies.

MCP1630/MCP1630V

6.0 PACKAGING INFORMATION

6.1 Package Marking Information

8-Lead MSOP

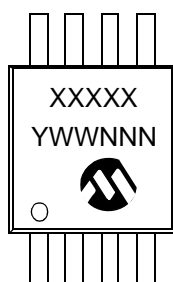

Example:

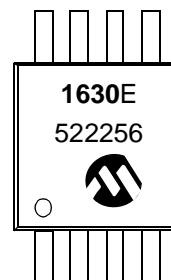

Example:

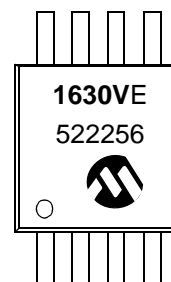

8-Lead DFN (2 mm x 3 mm)

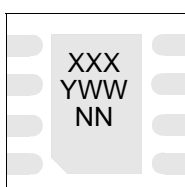

Example:

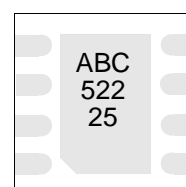

For DFN samples, contact your Microchip Sales Office for availability..

Legend:	XX...X	Customer-specific information
	Y	Year code (last digit of calendar year)
	YY	Year code (last 2 digits of calendar year)
	WW	Week code (week of January 1 is week '01')
	NNN	Alphanumeric traceability code
	(e3)	Pb-free JEDEC designator for Matte Tin (Sn)
	*	This package is Pb-free. The Pb-free JEDEC designator (e3) can be found on the outer packaging for this package.
Note:	In the event the full Microchip part number cannot be marked on one line, it will be carried over to the next line, thus limiting the number of available characters for customer-specific information.	

MCP1630/MCP1630V

8-Lead Plastic Micro Small Outline Package (MS) (MSOP)

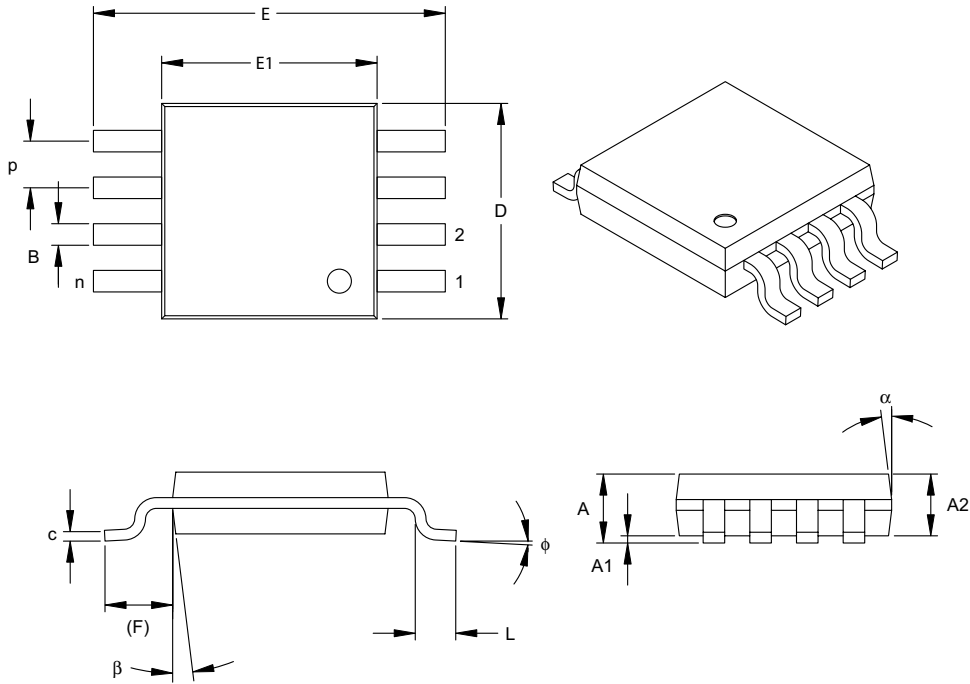

Units		INCHES			MILLIMETERS*		
Dimension Limits		MIN	NOM	MAX	MIN	NOM	MAX
Number of Pins	n	8			8		
Pitch	P	.026 BSC			0.65 BSC		
Overall Height	A	-	-	.043	-	-	1.10
Molded Package Thickness	A2	.030	.033	.037	0.75	0.85	0.95
Standoff	A1	.000	-	.006	0.00	-	0.15
Overall Width	E	.193 TYP.			4.90 BSC		
Molded Package Width	E1	.118 BSC			3.00 BSC		
Overall Length	D	.118 BSC			3.00 BSC		
Foot Length	L	.016	.024	.031	0.40	0.60	0.80
Footprint (Reference)	F	.037 REF			0.95 REF		
Foot Angle	phi	0°	-	8°	0°	-	8°
Lead Thickness	c	.003	.006	.009	0.08	-	0.23
Lead Width	B	.009	.012	.016	0.22	-	0.40
Mold Draft Angle Top	alpha	5°	-	15°	5°	-	15°
Mold Draft Angle Bottom	beta	5°	-	15°	5°	-	15°

*Controlling Parameter

Notes:

Dimensions D and E1 do not include mold flash or protrusions. Mold flash or protrusions shall not exceed .010" (0.254mm) per side.

JEDEC Equivalent: MO-187

Drawing No. C04-111

MCP1630/MCP1630V

8-Lead Plastic Dual Flat No Lead Package (MC) 2x3x0.9 mm Body (DFN) – Saw Singulated

For DFN samples, contact your Microchip Sales Office for availability..

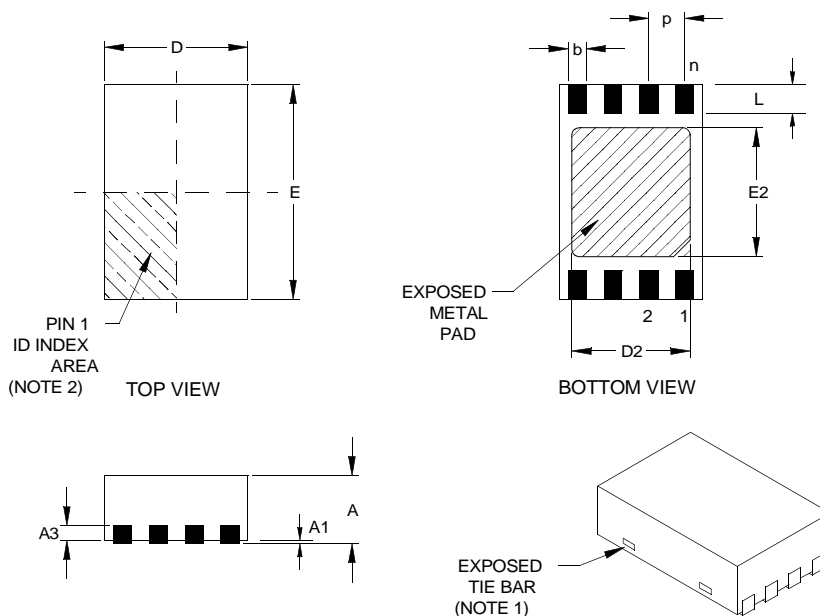

Units		INCHES			MILLIMETERS*		
Dimension Limits		MIN	NOM	MAX	MIN	NOM	MAX
Number of Pins	n		8			8	
Pitch	p	.020 BSC			0.50 BSC		
Overall Height	A	.031	.035	.039	0.80	0.90	1.00
Standoff	A1	.000	.001	.002	0.00	0.02	0.05
Contact Thickness	A3	.008 REF.			0.20 REF.		
Overall Length	D	.079 BSC			2.00 BSC		
Exposed Pad Length	(Note 3) D2	.055	.065	.067	1.39	1.65	1.70
Overall Width	E	.118 BSC			3.00 BSC		
Exposed Pad Width	(Note 3) E2	.047	.059	.061	1.20	1.50	1.55
Contact Width	b	.008	.010	.012	0.20	0.25	0.30
Contact Length	L	.012	.016	.020	0.30	0.40	0.50

*Controlling Parameter

Notes:

1. BSC: Basic Dimension. Theoretically exact value shown without tolerances.
See ASME Y14.5M
2. REF: Reference Dimension, usually without tolerance, for information purposes only.
See ASME Y14.5M

Exposed pad varies according to die attach paddle size.

Package may have one or more exposed tie bars at ends.

Pin 1 visual index feature may vary, but must be located within the hatched area.

JEDEC equivalent: M0-229

Drawing No. C04-123, Revised 05-05-05

MCP1630/MCP1630V

NOTES:

APPENDIX A: REVISION HISTORY

Revision B (June 2005)

The following is the list of modifications:

1. Added MCP1630V device information throughout data sheet
2. Added DFN package information throughout data sheet.
3. Added Appendix A: Revision History.

Revision A (June 2004)

- Original Release of this Document.

MCP1630/MCP1630V

NOTES:

MCP1630/MCP1630V

PRODUCT IDENTIFICATION SYSTEM

To order or obtain information, e.g., on pricing or delivery, refer to the factory or the listed sales office.

<u>PART NO.</u>	X	XX
Device	Temperature Range	Package
Device:	MCP1630: High-Speed, Microcontroller-Adaptable, PWM MCP1630T: High-Speed, Microcontroller-Adaptable, PWM (Tape and Reel)	
Temperature Range:	E = -40°C to +125°C	
Package:	MC * = Dual Flat, No Lead (2x3mm Body), 8-lead MS = Plastic MSOP, 8-lead * For DFN samples, contact your Microchip Sales Office for availability.	

Examples:

- a) MCP1630-E/MS: Extended Temperature, 8LD MSOP package.
- b) MCP1630T-E/MS: Tape and Reel Extended Temperature, 8LD MSOP package.
- c) MCP1630-E/MC: Extended Temperature, 8LD DFN package.

- a) MCP1630V-E/MS: Extended Temperature, 8LD MSOP package.
- b) MCP1630VT-E/MS: Tape and Reel Extended Temperature, 8LD MSOP package.
- c) MCP1630V-E/MC: Extended Temperature, 8LD DFN package.

MCP1630/MCP1630V

NOTES:

Note the following details of the code protection feature on Microchip devices:

- Microchip products meet the specification contained in their particular Microchip Data Sheet.
- Microchip believes that its family of products is one of the most secure families of its kind on the market today, when used in the intended manner and under normal conditions.
- There are dishonest and possibly illegal methods used to breach the code protection feature. All of these methods, to our knowledge, require using the Microchip products in a manner outside the operating specifications contained in Microchip's Data Sheets. Most likely, the person doing so is engaged in theft of intellectual property.
- Microchip is willing to work with the customer who is concerned about the integrity of their code.
- Neither Microchip nor any other semiconductor manufacturer can guarantee the security of their code. Code protection does not mean that we are guaranteeing the product as "unbreakable."

Code protection is constantly evolving. We at Microchip are committed to continuously improving the code protection features of our products. Attempts to break Microchip's code protection feature may be a violation of the Digital Millennium Copyright Act. If such acts allow unauthorized access to your software or other copyrighted work, you may have a right to sue for relief under that Act.

Information contained in this publication regarding device applications and the like is provided only for your convenience and may be superseded by updates. It is your responsibility to ensure that your application meets with your specifications. MICROCHIP MAKES NO REPRESENTATIONS OR WARRANTIES OF ANY KIND WHETHER EXPRESS OR IMPLIED, WRITTEN OR ORAL, STATUTORY OR OTHERWISE, RELATED TO THE INFORMATION, INCLUDING BUT NOT LIMITED TO ITS CONDITION, QUALITY, PERFORMANCE, MERCHANTABILITY OR FITNESS FOR PURPOSE. Microchip disclaims all liability arising from this information and its use. Use of Microchip's products as critical components in life support systems is not authorized except with express written approval by Microchip. No licenses are conveyed, implicitly or otherwise, under any Microchip intellectual property rights.

Trademarks

The Microchip name and logo, the Microchip logo, Accuron, dsPIC, KEELOQ, microID, MPLAB, PIC, PICmicro, PICSTART, PRO MATE, PowerSmart, rfPIC, and SmartShunt are registered trademarks of Microchip Technology Incorporated in the U.S.A. and other countries.

AmpLab, FilterLab, Migratable Memory, MXDEV, MXLAB, PICMASTER, SEEVAL, SmartSensor and The Embedded Control Solutions Company are registered trademarks of Microchip Technology Incorporated in the U.S.A.

Analog-for-the-Digital Age, Application Maestro, dsPICDEM, dsPICDEM.net, dsPICworks, ECAN, ECONOMONITOR, FanSense, FlexROM, fuzzyLAB, In-Circuit Serial Programming, ICSP, ICEPIC, Linear Active Thermistor, MPASM, MPLIB, MPLINK, MPSIM, PICKit, PICDEM, PICDEM.net, PICLAB, PICTail, PowerCal, PowerInfo, PowerMate, PowerTool, rLAB, rfPICDEM, Select Mode, Smart Serial, SmartTel, Total Endurance and WiperLock are trademarks of Microchip Technology Incorporated in the U.S.A. and other countries.

SQTP is a service mark of Microchip Technology Incorporated in the U.S.A.

All other trademarks mentioned herein are property of their respective companies.

© 2005, Microchip Technology Incorporated, Printed in the U.S.A., All Rights Reserved.

 Printed on recycled paper.

QUALITY MANAGEMENT SYSTEM
CERTIFIED BY DNV
== ISO/TS 16949:2002 ==

Microchip received ISO/TS-16949:2002 quality system certification for its worldwide headquarters, design and wafer fabrication facilities in Chandler and Tempe, Arizona and Mountain View, California in October 2003. The Company's quality system processes and procedures are for its PICmicro® 8-bit MCUs, KEELOQ® code hopping devices, Serial EEPROMs, microperipherals, nonvolatile memory and analog products. In addition, Microchip's quality system for the design and manufacture of development systems is ISO 9001:2000 certified.



WORLDWIDE SALES AND SERVICE

AMERICAS

Corporate Office
2355 West Chandler Blvd.
Chandler, AZ 85224-6199
Tel: 480-792-7200
Fax: 480-792-7277
Technical Support:
<http://support.microchip.com>
Web Address:
www.microchip.com

Atlanta

Alpharetta, GA
Tel: 770-640-0034
Fax: 770-640-0307

Boston

Westborough, MA
Tel: 774-760-0087
Fax: 774-760-0088

Chicago

Itasca, IL
Tel: 630-285-0071
Fax: 630-285-0075

Dallas

Addison, TX
Tel: 972-818-7423
Fax: 972-818-2924

Detroit

Farmington Hills, MI
Tel: 248-538-2250
Fax: 248-538-2260

Kokomo

Kokomo, IN
Tel: 765-864-8360
Fax: 765-864-8387

Los Angeles

Mission Viejo, CA
Tel: 949-462-9523
Fax: 949-462-9608

San Jose

Mountain View, CA
Tel: 650-215-1444
Fax: 650-961-0286

Toronto

Mississauga, Ontario,
Canada
Tel: 905-673-0699
Fax: 905-673-6509

ASIA/PACIFIC

Australia - Sydney
Tel: 61-2-9868-6733
Fax: 61-2-9868-6755

China - Beijing
Tel: 86-10-8528-2100
Fax: 86-10-8528-2104

China - Chengdu
Tel: 86-28-8676-6200
Fax: 86-28-8676-6599

China - Fuzhou
Tel: 86-591-8750-3506
Fax: 86-591-8750-3521

China - Hong Kong SAR
Tel: 852-2401-1200
Fax: 852-2401-3431

China - Shanghai
Tel: 86-21-5407-5533
Fax: 86-21-5407-5066

China - Shenyang
Tel: 86-24-2334-2829
Fax: 86-24-2334-2393

China - Shenzhen
Tel: 86-755-8203-2660
Fax: 86-755-8203-1760

China - Shunde
Tel: 86-757-2839-5507
Fax: 86-757-2839-5571

China - Qingdao
Tel: 86-532-502-7355
Fax: 86-532-502-7205

ASIA/PACIFIC

India - Bangalore
Tel: 91-80-2229-0061
Fax: 91-80-2229-0062

India - New Delhi
Tel: 91-11-5160-8631
Fax: 91-11-5160-8632

Japan - Kanagawa
Tel: 81-45-471-6166
Fax: 81-45-471-6122

Korea - Seoul
Tel: 82-2-554-7200
Fax: 82-2-558-5932 or
82-2-558-5934

Malaysia - Penang
Tel: 011-604-646-8870
Fax: 011-604-646-5086

Philippines - Manila
Tel: 011-632-634-9065
Fax: 011-632-634-9069

Singapore
Tel: 65-6334-8870
Fax: 65-6334-8850

Taiwan - Kaohsiung
Tel: 886-7-536-4818
Fax: 886-7-536-4803

Taiwan - Taipei
Tel: 886-2-2500-6610
Fax: 886-2-2508-0102

Taiwan - Hsinchu
Tel: 886-3-572-9526
Fax: 886-3-572-6459

EUROPE

Austria - Weis
Tel: 43-7242-2244-399
Fax: 43-7242-2244-393

Denmark - Ballerup
Tel: 45-4450-2828
Fax: 45-4485-2829

France - Massy
Tel: 33-1-69-53-63-20
Fax: 33-1-69-30-90-79

Germany - Ismaning
Tel: 49-89-627-144-0
Fax: 49-89-627-144-44

Italy - Milan
Tel: 39-0331-742611
Fax: 39-0331-466781

Netherlands - Drunen
Tel: 31-416-690399
Fax: 31-416-690340

England - Berkshire
Tel: 44-118-921-5869
Fax: 44-118-921-5820