

# C&K OS Series Miniature Slide Switches

## Features/Benefits

- Variety of actuators & terminations
- PC and panel mounting
- Gold or silver plating available
- Shorting or non-shorting contacts
- RoHS compliant

## Typical Applications

- Test & measurement equipment
- Computer peripherals & network products
- Consumer products



## Specifications

CONTACT RATING: See individual parts.  
 MECHANICAL & ELECTRICAL LIFE: 10,000 cycles.  
 CONTACT RESISTANCE: 20 m Ω or less.  
 INSULATION RESISTANCE: 100 m Ω min. at 500 VDC.  
 DIELECTRIC STRENGTH: 500 VAC for 1 minute.  
 OPERATING TEMPERATURE: -10°C to +70°C.  
 PACKAGING: Bulk

\* For RoHS compatible switches contact customer service.

## Materials

BASE: Phenolic resin.  
 ACTUATOR: POM, black.  
 HOUSING PLATE: SPCC Sn plated.  
 MOVABLE CONTACT: Copper alloy, silver plated or gold.  
 STATIONARY CONTACTS: Brass, silver plated.  
 TERMINALS: Brass, silver plated (Gold plate - Contact customer service).  
 TERMINAL SEAL: None.

**NOTE:** For the latest information regarding RoHS compliance, please go to: [www.ittcannon.com/rohs](http://www.ittcannon.com/rohs).

**NOTE:** Specifications and materials listed above are for switches with standard options. For information on specific and custom switches, consult Customer Service Center.

## How To Order

Complete part numbers for OS Series Slide Switches are shown on pages J-36 through J-42.

PART NUMBER	SWITCH FUNCTION	
	POS. 1	POS. 2
<b>OS102011MS2QN1</b> (Non-shorting)	ON	ON
<b>OS102011MS2QS1</b> (Shorting)	ON	ON
CONN. TERMINALS	1-2	2-3
SCHEMATIC		
SPDT		
CONTACT RATING: 0.1A @ 12 VDC		

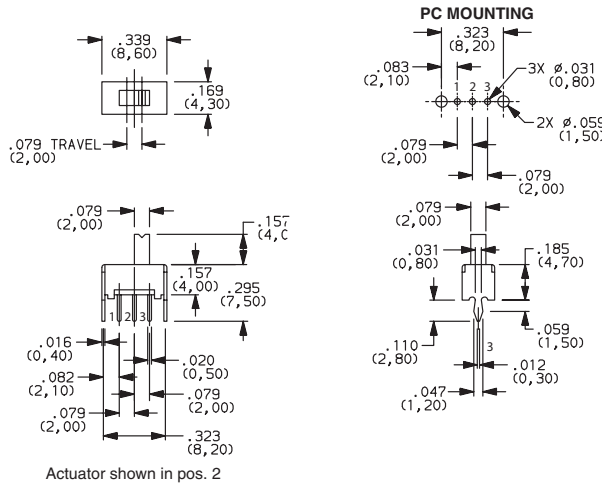

PART NUMBER	SWITCH FUNCTION		
	POS. 1	POS. 2	POS. 3
<b>OS103011MS8QP1</b> (Non-specified)	ON	ON	ON
CONN. TERMINALS	1-2	2-3	2-4
SCHEMATIC			
SP3T			
CONTACT RATING: 0.1A @ 12 VDC			

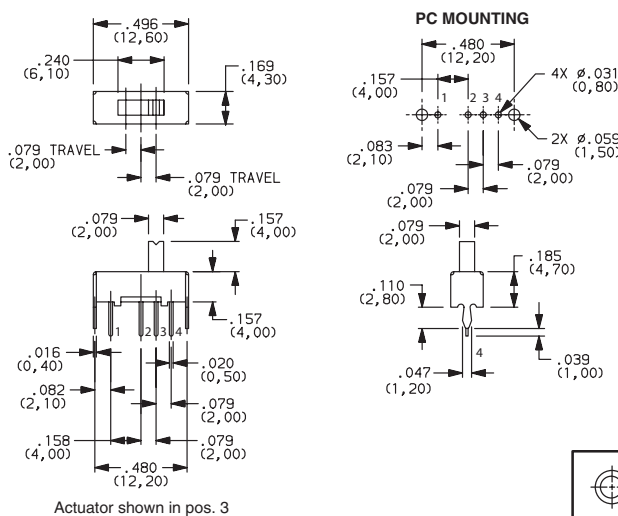

Dimensions are shown: Inch (mm)  
 Specifications and dimensions subject to change

# C&K OS Series Miniature Slide Switches



**OS202011MS2QS1  
DPDT**

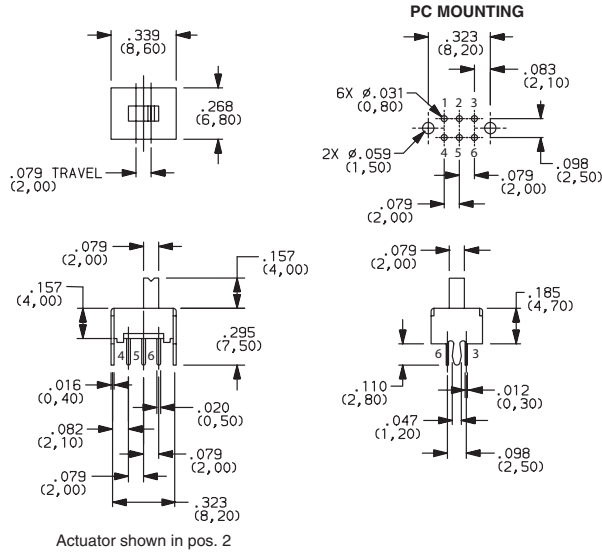

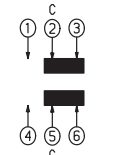
PART NUMBER	SWITCH FUNCTION	
	POS.1	POS. 2
<b>OS202011MS2QS1</b> (Shorting)	ON	ON
<b>OS202011MS2QN1</b> (Non-shorting)	ON	ON
CONN. TERMINALS	1-2,4-5	2-3,5-6
SCHEMATIC		
		
DPDT		
CONTACT RATING: 0.1A @ 12 VDC		



**OS203011MS1QP1  
DP3T**

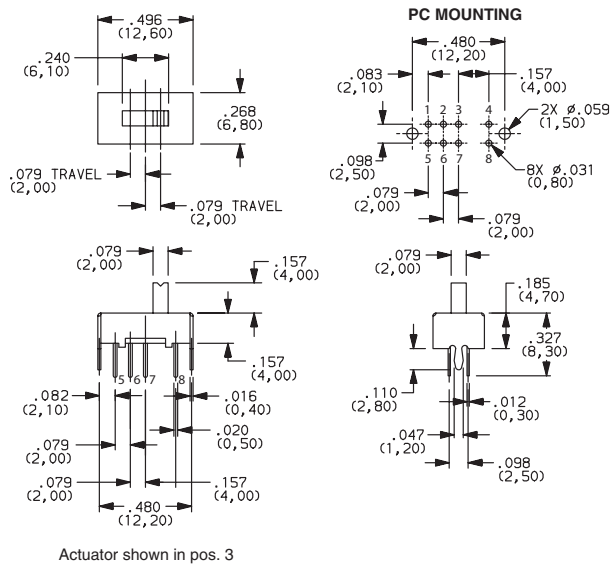

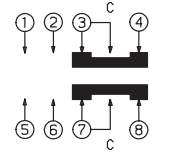
PART NUMBER	SWITCH FUNCTION		
	POS.1	POS. 2	POS. 3
<b>OS203011MS1QP1</b> (Non-specified)	ON	ON	ON
CONN. TERMINALS	1-3,5-7	2-3,6-7	3-4,7-8
SCHEMATIC			
			
DP3T			
CONTACT RATING: 0.3A @ 30 VDC			



**OS202013MT5QN1  
DPDT**

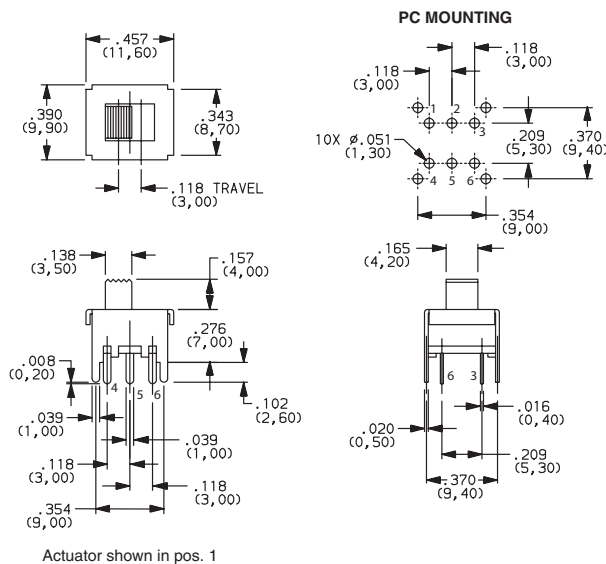

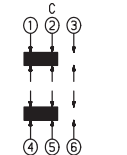
PART NUMBER	SWITCH FUNCTION	
	POS.1	POS. 2
<b>OS202013MT5QN1</b> (Non-shorting)	ON	ON
CONN. TERMINALS	1-2,4-5	2-3,5-6
SCHEMATIC		
		
DPDT		
CONTACT RATING: 0.3A @ 30 VDC		

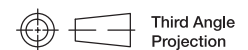

Dimensions are shown: IN (mm)  
Specifications and dimensions subject to change



# C&K OS Series Miniature Slide Switches

Slide

PART NUMBER	SWITCH FUNCTION		
	POS.1	POS. 2	POS. 3
<b>OS203013MT7QN1</b> (Non-shorting)	ON	OFF	ON
CONN. TERMINALS	1-2,4-5		2-3,5-6
SCHEMATIC			
DP3T			
CONTACT RATING: 0.3A @ 30 VDC			

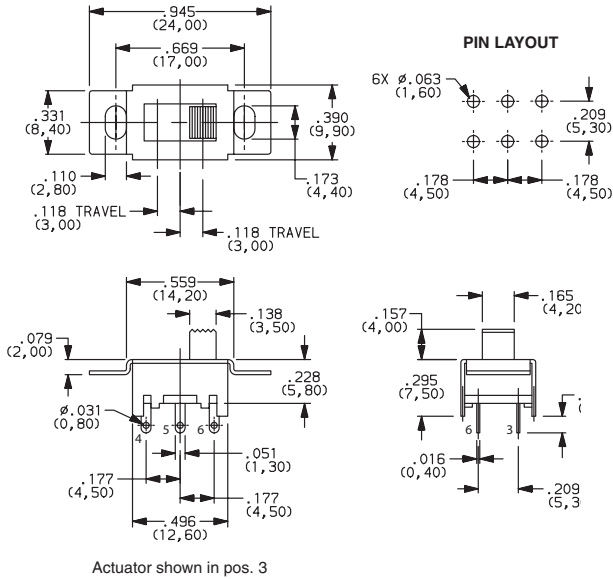

OS203013MT7QN1  
DP3T

PART NUMBER	SWITCH FUNCTION	
	POS.1	POS. 2
<b>OS202013MT8QN1</b> (Non-shorting)	ON	ON
CONN. TERMINALS	1-2,4-5	2-3,5-6
SCHEMATIC		
DPDT		
CONTACT RATING: 0.3A @ 30 VDC		

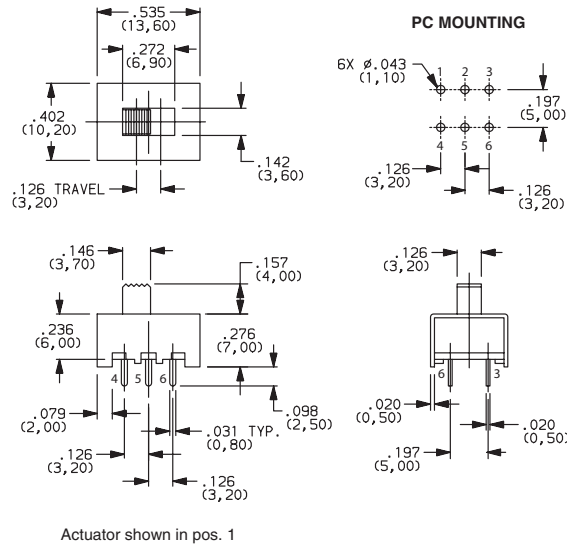

OS202013MT8QN1  
DPDT

PART NUMBER	SWITCH FUNCTION		
	POS.1	POS. 2	POS. 3
<b>OS203013MT8QN1</b> (Non-shorting)	ON	ON	ON
CONN. TERMINALS	1-2,5-6	2-3,6-7	3-4,7-8
SCHEMATIC			
DP3T			
CONTACT RATING: 0.3A @ 30 VDC			

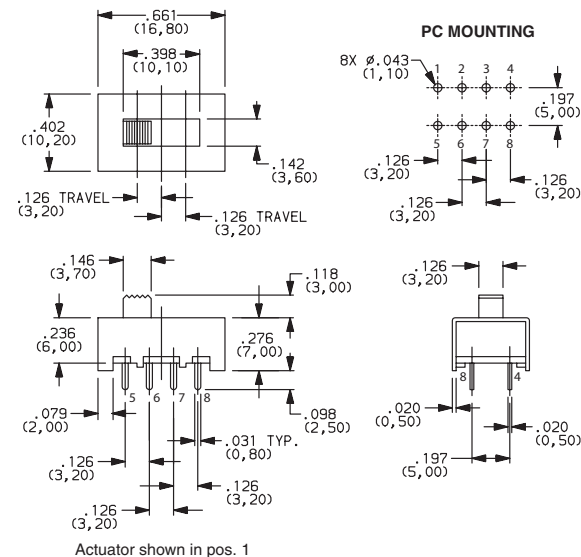

OS203013MT8QN1  
DP3T

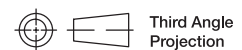

Dimensions are shown: Inch (mm)  
Specifications and dimensions subject to change

# C&K OS Series Miniature Slide Switches



OS203013MT6QN1  
DP3T

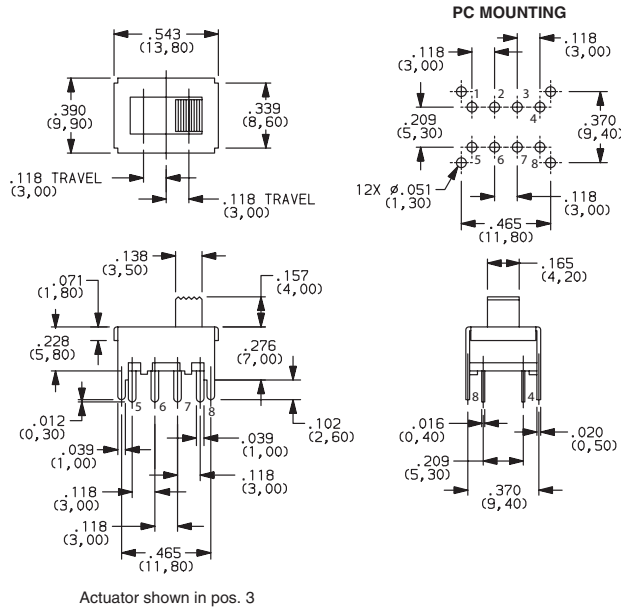

PART NUMBER	SWITCH FUNCTION		
	POS.1	POS. 2	POS. 3
<b>OS203013MT6QN1</b> (Non-shorting)	ON	ON	ON
CONN. TERMINALS	1-2,5-6	2-3,6-7	3-4,7-8
SCHEMATIC			
DP3T			
CONTACT RATING: 0.2A @ 30 VDC			



OS103012MU1QP1  
SP3T

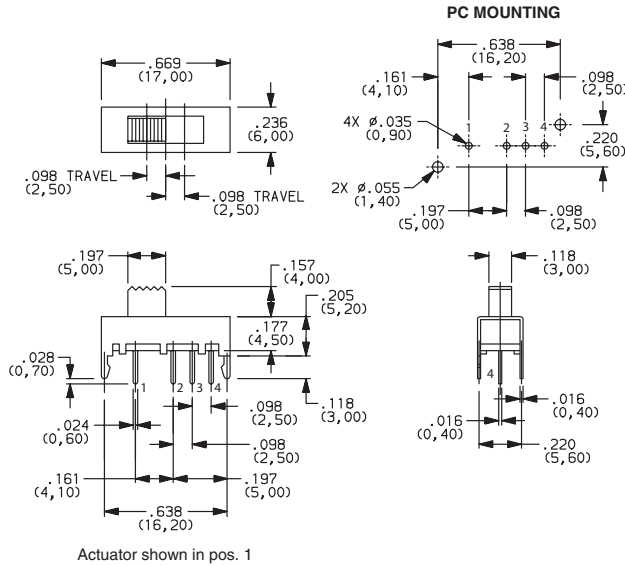

PART NUMBER	SWITCH FUNCTION		
	POS.1	POS. 2	POS. 3
<b>OS103012MU1QP1</b> (Non-shorting)	ON	ON	ON
CONN. TERMINALS	1-2	2-3	2-4
SCHEMATIC			
SP3T			
CONTACT RATING: 0.2A @ 30 VDC			



OS103012MU2QP1  
SP3T

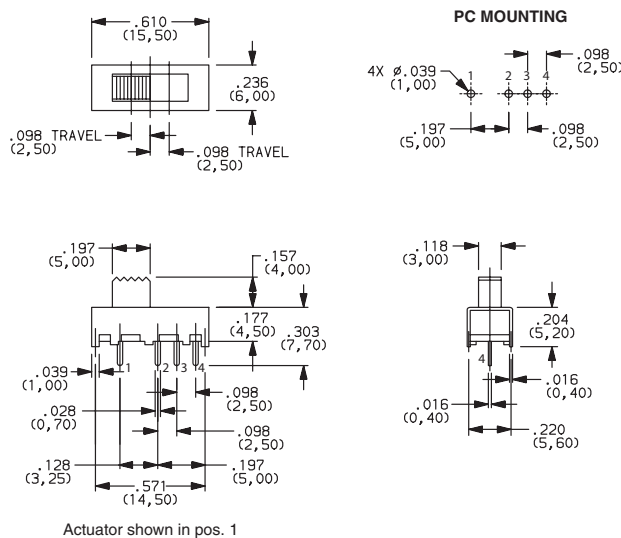

PART NUMBER	SWITCH FUNCTION		
	POS.1	POS. 2	POS. 3
<b>OS103012MU2QP1</b> (Non-shorting)	ON	ON	ON
CONN. TERMINALS	1-2	2-3	2-4
SCHEMATIC			
SP3T			
CONTACT RATING: 0.2A @ 30 VDC			



Dimensions are shown: IN (mm)  
Specifications and dimensions subject to change

# C&K OS Series Miniature Slide Switches

Slide

PART NUMBER	SWITCH FUNCTION		
	POS.1	POS. 2	POS. 3
<b>OS203012MU5QP1</b> (Non-specified)			
CONN. TERMINALS	1-2,5-6	2-3,6-7	2-4,6-8
SCHEMATIC			
DP3T			
CONTACT RATING: 0.1A @ 30 VDC			

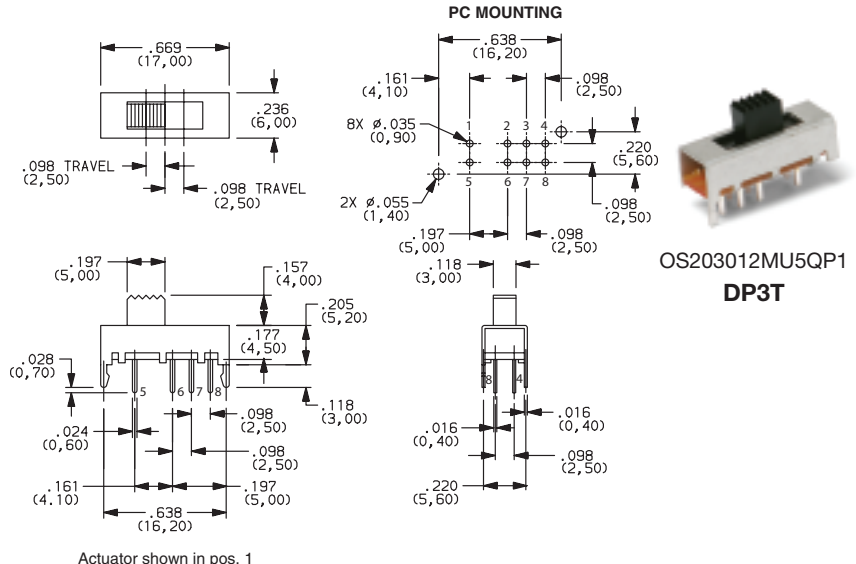

OS203012MU5QP1  
DP3T

PART NUMBER	SWITCH FUNCTION	
	POS.1	POS. 2
<b>OS202011MV4QN1</b> (Non-shorting)		
<b>OS202011MV4QS1</b> (Shorting)		
CONN. TERMINALS	1-2,4-5	2-3,5-6
SCHEMATIC		
DPDT		
CONTACT RATING: 0.1A @ 30 VDC		

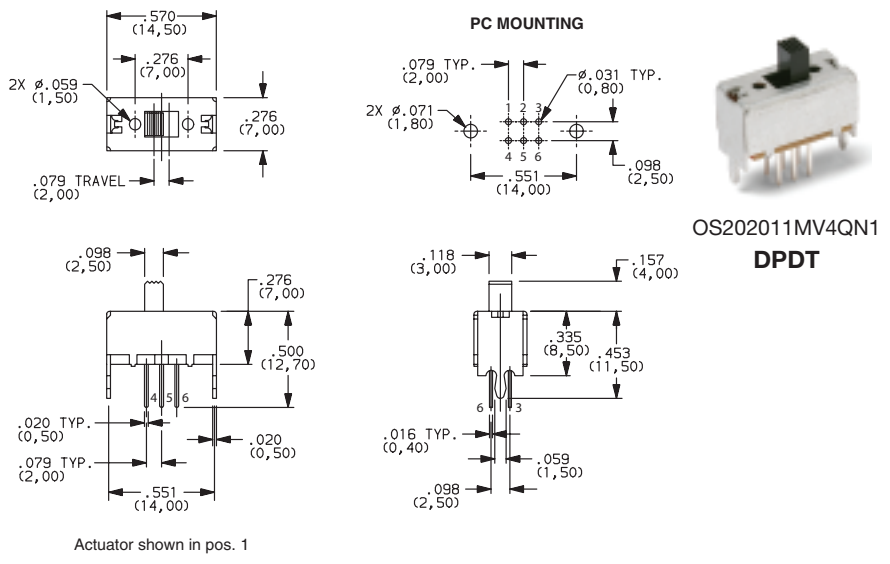

OS202011MV4QN1  
DPDT

PART NUMBER	SWITCH FUNCTION		
	POS.1	POS. 2	POS. 3
<b>OS203011MV9QS1</b> (Shorting)			
<b>OS203011MV9QN1</b> (Non-shorting)			
CONN. TERMINALS	1-2-5, 6-7-10	1-3-5, 6-8-10	1-4-5, 6-9-10
SCHEMATIC			
DP3T			
CONTACT RATING: 0.1A @ 30 VDC			

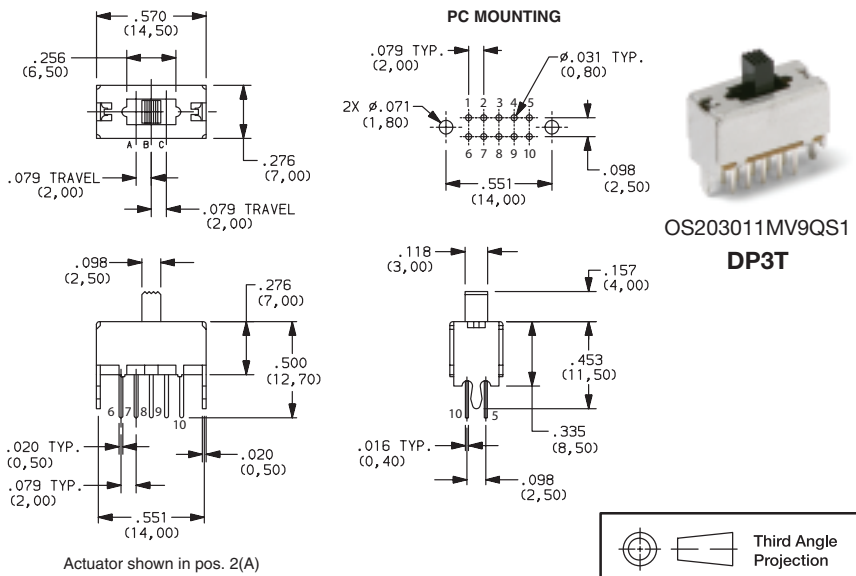

OS203011MV9QS1  
DP3T

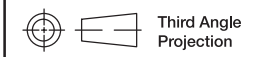

Dimensions are shown: Inch (mm)  
Specifications and dimensions subject to change

# C&K OS Series Miniature Slide Switches



OS102011MA1QN1  
SPDT

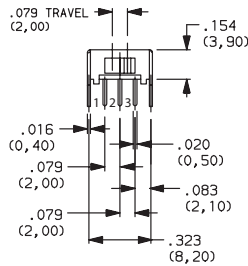
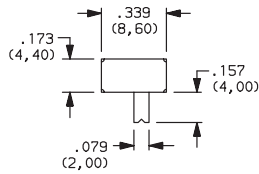

Actuator shown in pos. 2

PC MOUNTING

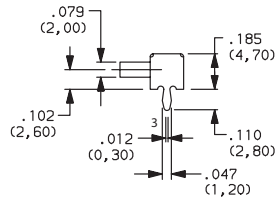
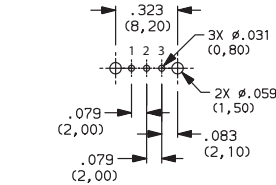

PART NUMBER	SWITCH FUNCTION	
	POS. 1	POS. 2
<b>OS102011MA1QN1</b> (Non-shorting)		
<b>OS102011MA1QS1</b> (Shorting)		
CONN. TERMINALS	1-2	2-3
SCHEMATIC		
SPDT		
CONTACT RATING: 0.1A @ 12 VDC		



OS103011MA7QP1  
SP3T

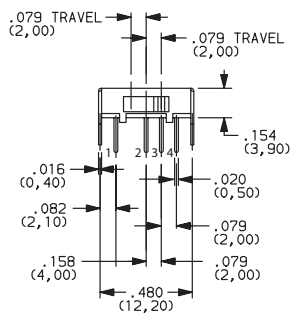
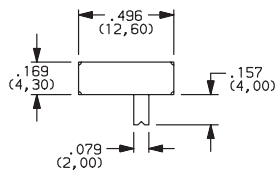

Actuator shown in pos. 3

PC MOUNTING

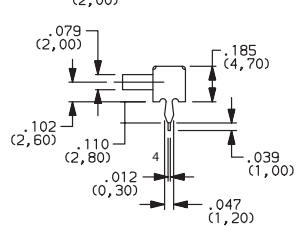
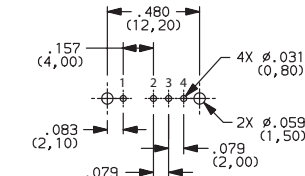

PART NUMBER	SWITCH FUNCTION		
	POS. 1	POS. 2	POS. 3
<b>OS103011MA7QP1</b> (Non-specified)			
CONN. TERMINALS	1-2	2-3	2-4
SCHEMATIC			
SP3T			
CONTACT RATING: 0.1A @ 12 VDC			



OS203011MA2QP1  
DP3T

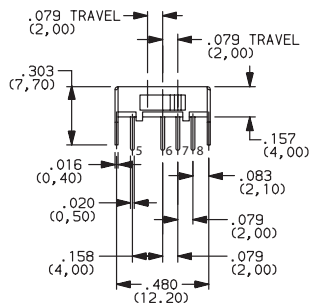
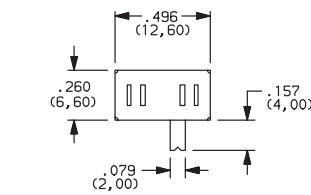

Actuator shown in pos. 3

PC MOUNTING

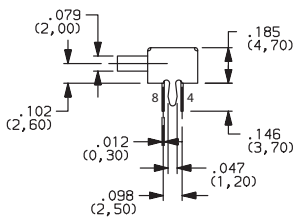
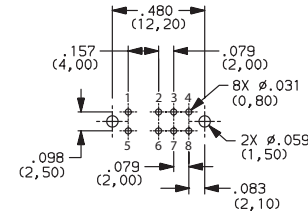

PART NUMBER	SWITCH FUNCTION		
	POS. 1	POS. 2	POS. 3
<b>OS203011MA2QP1</b> (Non-specified)			
CONN. TERMINALS	1-2,5-6	2-3,6-7	2-4,6-8
SCHEMATIC			
DP3T			
CONTACT RATING: 0.1A @ 12 VDC			

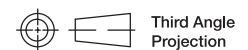

Dimensions are shown: IN (mm)  
Specifications and dimensions subject to change



Slide

# C&K OS Series Miniature Slide Switches

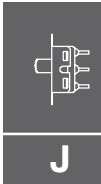

Slide

PART NUMBER	SWITCH FUNCTION	
	POS.1	POS. 2
<b>OS202011MA0QN1</b> (Non-shorting)	ON	ON
<b>OS202011MA0QS1</b> (Shorting)	ON	ON
CONN. TERMINALS	1-2,4-5	2-3,5-6
SCHEMATIC		
DPDT		
CONTACT RATING: 0.1A @ 12 VDC		

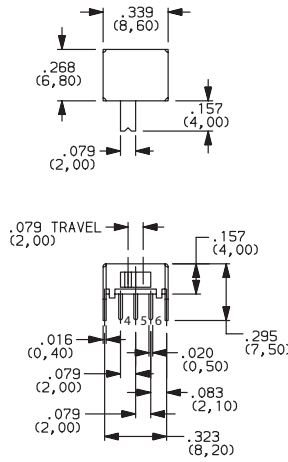

Actuator shown in pos. 1

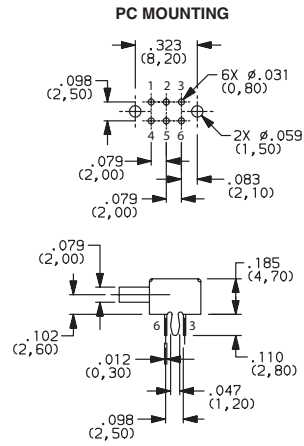

OS202011MA0QN1  
DPDT

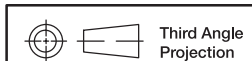

Dimensions are shown: Inch (mm)  
Specifications and dimensions subject to change