

# 0603<1.6×0.8 t=0.36mm> Standard Type

## SML-E12\*8 Series EXCELED™

Emitting Color	Pure Green	Green(Yellowish Green)	Yellow	Orange	Red	
Material	AlGaInP on GaAs					
Package Size(mm)						
	1608(0603) 1.6×0.8(t=0.36)					
Part No.	SML-E12P8W	SML-E12M8W	SML-E12Y8W	SML-E12D8W	SML-E12U8W	SML-E12V8W

### Absolute Maximum Ratings (Ta=25°C)

Part No.	Emitting color	Power dissipation Pd (mW)	Forward current IF (mA)	Peak forward current *IFP (mA)	Reverse voltage VR (V)	Operating temperature Topr (C)	Storage temperature Tstg (C)
SML-E12P8W	Pure Green	54	20	100	5	-40 to +85	-40 to +100
SML-E12M8W	Green (Yellowish Green)						
SML-E12Y8W	Yellow	54	20	100	5	-40 to +85	-40 to +100
SML-E12D8W	Orange						
SML-E12U8W	Red	54	20	100	5	-40 to +85	-40 to +100
SML-E12V8W	Red						

\*:Duty ≤1/10, 1kHz.

### Dimensions (Unit:mm)

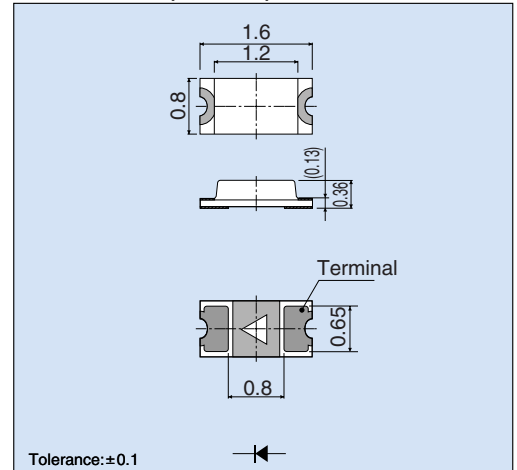

### Electrical Optical Characteristics (Ta=25°C)

Part No.	Resin Color	Forward voltage VF		Reverse current IR		Light wavelength Dominant λD		Brightness Iv		
		Typ. (V)	IF * (mA)	Max. (μA)	VR (V)	Typ. (nm)	IF * (mA)	Min. (mcd)	Typ. (mcd)	IF * (mA)
SML-E12P8W	Diffused	2.2	20	10	4	560	20	2.5	6.3	20
SML-E12M8W						572		10	25	
SML-E12Y8W	Milky White	2.2	20	10	4	590	20	25	63	20
SML-E12D8W						605		40	100	
SML-E12U8W	Milky White	2.2	20	10	4	620	20	25	63	20
SML-E12V8W						630		16	40	

\*Pulse width : 30ms.

### Directivity (Typ.)

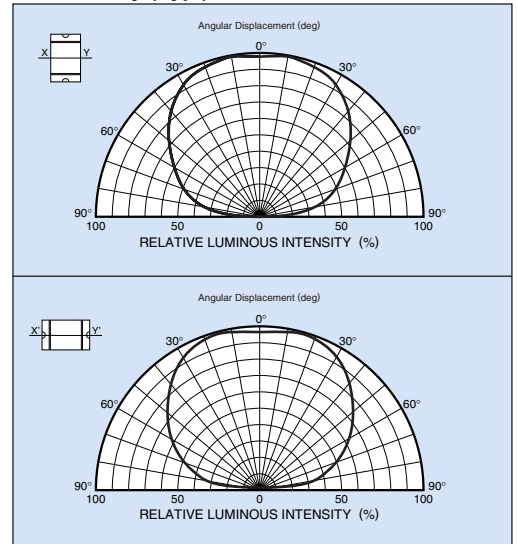

### Recommended Pad Layout

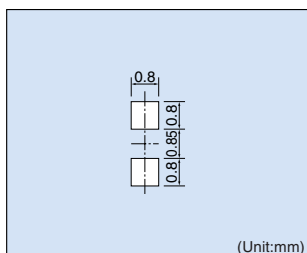

The recommended thickness of the screen mask for soldering is between 100 and 150μm. The hole size of the screen mask should be same as the recommended land pattern or smaller.

### Packaging Specifications (Unit:mm)

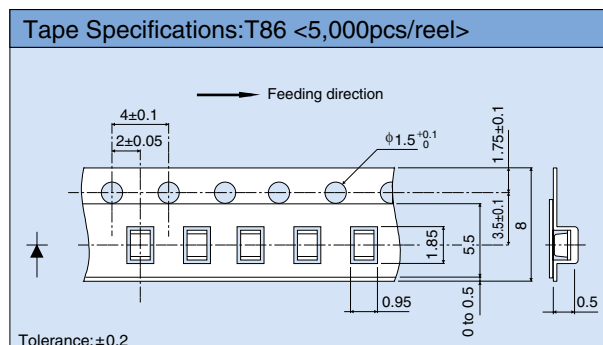

### Reel Specifications

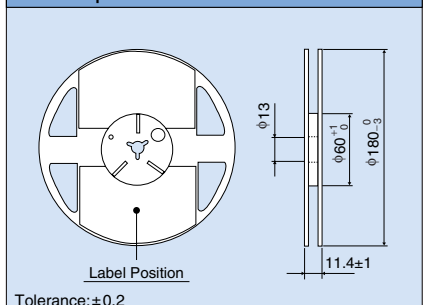

## Electrical Characteristic Curves

### Forward Current - Forward Voltage

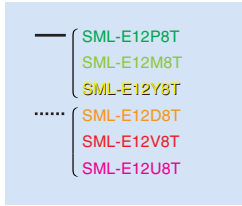
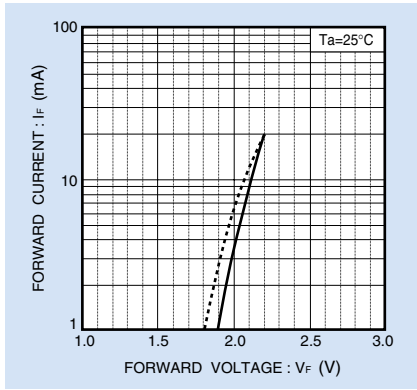

### Relative Luminous Intensity - Case Temperature

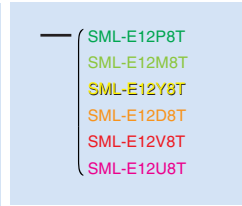
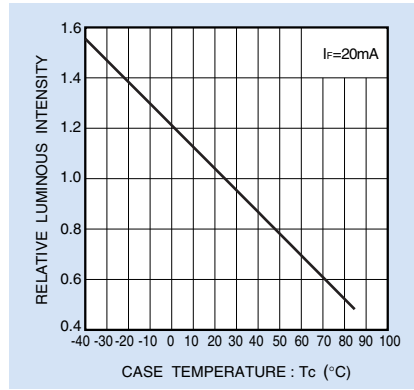

### Relative Luminous Intensity - Forward Current

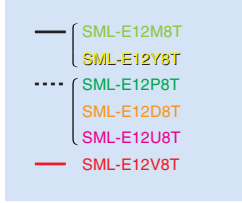
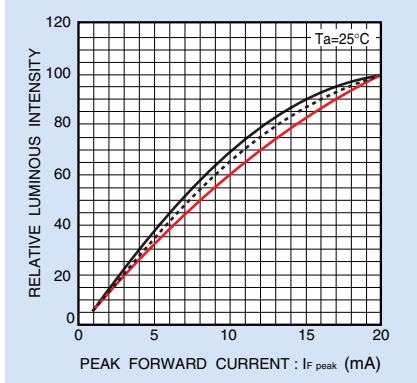

### Ratio of Maximum Tolerable Peak Current - Pulse Duration

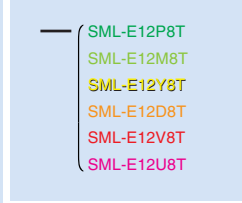
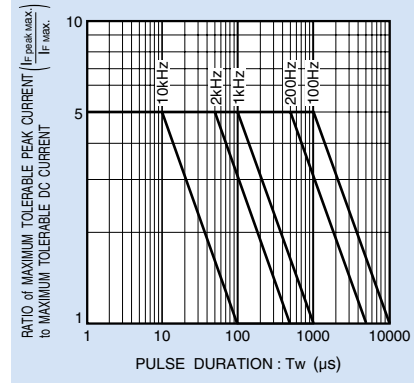

### Derating

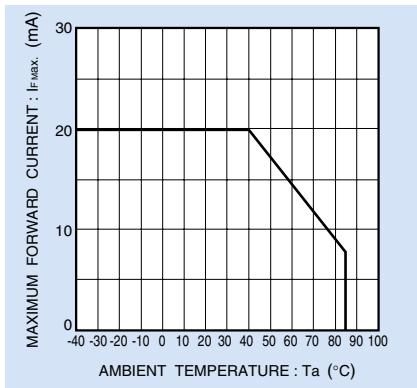

### Notes

- No technical content pages of this document may be reproduced in any form or transmitted by any means without prior permission of ROHM CO.,LTD.
- The contents described herein are subject to change without notice. The specifications for the product described in this document are for reference only. Upon actual use, therefore, please request that specifications to be separately delivered.
- Application circuit diagrams and circuit constants contained herein are shown as examples of standard use and operation. Please pay careful attention to the peripheral conditions when designing circuits and deciding upon circuit constants in the set.
- Any data, including, but not limited to application circuit diagrams information, described herein are intended only as illustrations of such devices and not as the specifications for such devices. ROHM CO.,LTD. disclaims any warranty that any use of such devices shall be free from infringement of any third party's intellectual property rights or other proprietary rights, and further, assumes no liability of whatsoever nature in the event of any such infringement, or arising from or connected with or related to the use of such devices.
- Upon the sale of any such devices, other than for buyer's right to use such devices itself, resell or otherwise dispose of the same, no express or implied right or license to practice or commercially exploit any intellectual property rights or other proprietary rights owned or controlled by
- ROHM CO., LTD. is granted to any such buyer.
- Products listed in this document are no antiradiation design.

The products listed in this document are designed to be used with ordinary electronic equipment or devices (such as audio visual equipment, office-automation equipment, communications devices, electrical appliances and electronic toys).

Should you intend to use these products with equipment or devices which require an extremely high level of reliability and the malfunction of which would directly endanger human life (such as medical instruments, transportation equipment, aerospace machinery, nuclear-reactor controllers, fuel controllers and other safety devices), please be sure to consult with our sales representative in advance.

It is our top priority to supply products with the utmost quality and reliability. However, there is always a chance of failure due to unexpected factors. Therefore, please take into account the derating characteristics and allow for sufficient safety features, such as extra margin, anti-flammability, and fail-safe measures when designing in order to prevent possible accidents that may result in bodily harm or fire caused by component failure. ROHM cannot be held responsible for any damages arising from the use of the products under conditions out of the range of the specifications or due to non-compliance with the NOTES specified in this catalog.

Thank you for your accessing to ROHM product informations.

More detail product informations and catalogs are available, please contact your nearest sales office.

**ROHM** Customer Support System

THE AMERICAS / EUROPE / ASIA / JAPAN

[www.rohm.com](http://www.rohm.com)

Contact us : [webmaster@rohm.co.jp](mailto:webmaster@rohm.co.jp)