

General Description

The AAT1210 is a high power DC/DC boost (step-up) converter with an input voltage range from 2.7 to 5.5V. The output voltage can be set from $V_{IN} + 0.5V$ to 18V. The total solution is less than 1mm in height. High operating efficiency makes the AAT1210 the ideal solution for battery powered and consumer applications.

The step-up converter operates at frequencies up to 2MHz, enabling ultra-small external filtering components. Hysteretic current mode control provides excellent transient response with no external compensation, achieving stability across a wide operating range with minimal design effort.

The AAT1210 true load disconnect feature extends battery life by isolating the load from the power source when the EN/SET pin is pulled low, ensuring zero volts output during the disable state. This feature eliminates the external boost converter leakage path and achieves standby quiescent current $<1\mu A$ without an external switching device.

A fixed output voltage is set using two external resistors. Alternatively, the output may be adjusted dynamically across a 2.0x range. The output can toggle between two preset voltages using the SEL logic pin. Optionally, the output can be dynamically set to any one of 16 programmed levels using AnalogicTech's patented Simple Serial Control™ (S²Cwire™) interface.

The AAT1210 is available in a Pb-free, thermally-enhanced 16-pin 3x4mm TDFN low-profile package and is rated over the $-40^{\circ}C$ to $+85^{\circ}C$ temperature range.

Features

- V_{IN} Range: 2.7V to 5.5V
- Maximum Continuous Output
 - 900mA at 5V
 - 300mA at 12V
 - 150mA at 18V
- Up to 2MHz Switching Frequency
- Ultra-Small Inductor and Capacitors
 - 1mm Height Inductor
 - Small Ceramic Capacitors
- Hysteretic Current Mode Control
 - No External Compensation
 - Excellent Transient Response
 - High Efficiency at Light Load
- Up to 90% Efficiency
- Integrated Low $R_{DS(ON)}$ MOSFET Switches
- Low Inrush with Integrated Soft Start
- Cycle-by-Cycle Current Limit
- Short-Circuit and Over-Temperature Protection
- True Load Disconnect
- Optional Dynamic Voltage Programming
- TDFN34-16 Package
- $-40^{\circ}C$ to $+85^{\circ}C$ Temperature Range

Applications

- GPS Systems
- DVD Blu-Ray
- Handheld PCs
- PDA Phones
- Portable Media Players
- USB OTG

Typical Application

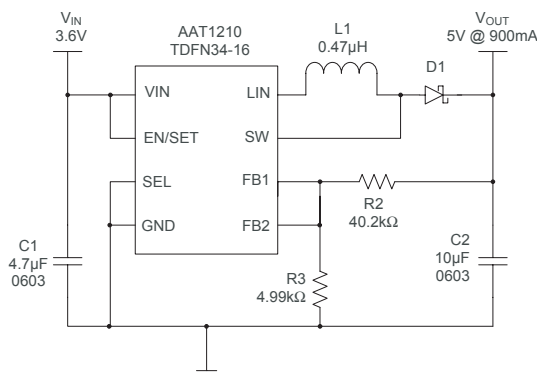

AAT1210 Boost Converter Output Capability
(TDFN34-16; $T_{AMB} = 25^{\circ}C$; $T_{C(RISE)} = +50^{\circ}C$)

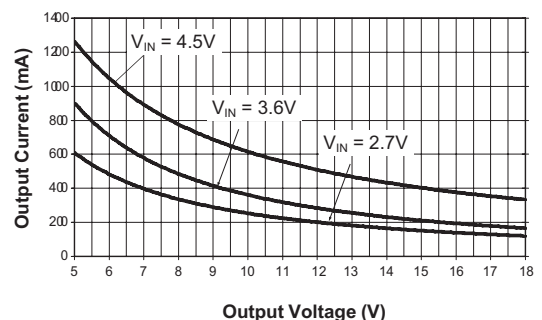

Pin Descriptions

Pin #	Symbol	Function
1, 2	LIN	Switched power input. Connect to the power inductor.
3	FB1	Feedback pin for high output voltage set point. Pin set to 1.2V when SEL is high and disabled when SEL is low. Disabled with S ² Cwire control. Tie directly to FB2 pin for static (fixed) output voltage.
4	FB2	Feedback pin for low output voltage set point. Pin set to 0.6V when SEL is low and disabled when SEL is high. Voltage is set from 0.6V to 1.2V with S ² Cwire control. Tie directly to FB1 pin for static (fixed) output voltage.
5	GND	Ground pin.
6, 7, 8	PGND	Power ground for the boost converter; connected to the source of the N-channel MOSFET. Connect to the input and output capacitor return.
9, 10	SW	Boost converter switching node. Connect the power inductor between this pin and the LIN pin.
11	N/C	No connection.
12	VIN	Input voltage for the converter. Connect this pin directly to the VP pin.
13	SEL	Logic high selects FB1 high output reference. Logic low selects FB2 low output reference. Pull low for S ² Cwire control.
14	EN/SET	Active high enable pin. Alternately, input pin for S ² Cwire control using the FB2 reference.
15, 16	VP	Input power pin; connected internally to the source of the P-channel MOSFET. Connect externally to the input capacitor(s).
EP		Exposed paddle (bottom). Connected internally to the SW pins. Can be tied to bottom side PCB heat sink to optimize thermal performance.

Pin Configuration

**TDFN34-16
(Top View)**

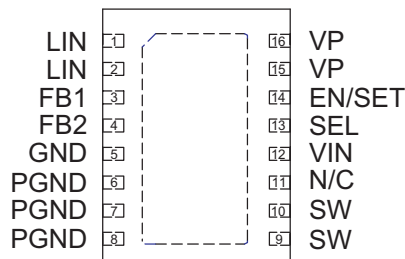

Absolute Maximum Ratings¹

Symbol	Description	Value	Units
V _{IN} , V _P	Input Voltage	-0.3 to 6.0	V
SW	Switching Node	20	V
LIN, EN/SET, SEL, FB1, FB2	Maximum Rating	V _{IN} + 0.3	V
T _J	Operating Temperature Range	-40 to 150	°C
T _S	Storage Temperature Range	-65 to 150	°C
T _{LEAD}	Maximum Soldering Temperature (at leads, 10 sec)	300	°C

Recommended Operating Conditions

Symbol	Description	Value	Units
θ _{JA}	Thermal Resistance	44	°C/W
P _D	Maximum Power Dissipation (T _A = 25°C)	2270	mW

1. Stresses above those listed in Absolute Maximum Ratings may cause permanent damage to the device. Functional operation at conditions other than the operating conditions specified is not implied. Only one Absolute Maximum Rating should be applied at any one time.

Electrical Characteristics¹

$V_{IN} = 3.6V$, $T_A = -40^{\circ}C$ to $+85^{\circ}C$, unless otherwise noted. Typical values are $T_A = 25^{\circ}C$.

Symbol	Description	Conditions	Min	Typ	Max	Units
Power Supply						
V_{IN}	Input Voltage Range		2.7		5.5	V
V_{OUT}	Output Voltage Range		$V_{IN} + 0.5V$		18	V
$I_{OUT(MAX)}$	Output Current ²	$V_{IN} = 2.7V, V_{OUT} = 5V$		600		mA
		$V_{IN} = 2.7V, V_{OUT} > 5V$		See note 2		
		$V_{IN} = 3.6V, V_{OUT} > 5V$		900		
V_{UVLO}	UVLO Threshold	V_{IN} Rising			2.7	V
		Hysteresis		150		mV
		V_{IN} Falling	1.8			V
I_Q	Quiescent Current	SEL = GND, $V_{OUT} = 5V$, No Load, Switching ³		250		μA
		SEL = GND, FB2 = 1.5V, Not Switching		40	70	μA
I_{SHDN}	VIN Pin Shutdown Current	EN/SET = GND			1.0	μA
FB1	FB1 Reference Voltage	$I_{OUT} = 0$ to $I_{OUT(MAX)}$ mA, $V_{IN} = 2.7V$ to $5.0V$, SEL = High	1.164	1.2	1.236	V
FB2	FB2 Reference Voltage	$I_{OUT} = 0$ to $I_{OUT(MAX)}$ mA, $V_{IN} = 2.7V$ to $5.0V$, SEL = Low	0.582	0.6	0.618	V
$\Delta V_{LOADREG}$	Load Regulation	$I_{OUT} = 0$ to $I_{OUT(MAX)}$ mA		0.01		%/mA
$\Delta V_{LINEREG}/\Delta V_{IN}$	Line Regulation	$V_{IN} = 3.0V$ to $5.5V$		0.6		%/V
$R_{DS(ON)L}$	Low Side Switch On Resistance			0.06		Ω
$R_{DS(ON)IN}$	Input Disconnect Switch On Resistance			0.18		Ω
T_{SS}	Soft-Start Time	From Enable to Output Regulation; $V_{OUT} = 15V$, $C_{OUT} = 10\mu F$		2.5		ms
T_{SD}	Over-Temperature Shutdown Threshold			140		$^{\circ}C$
T_{HYS}	Shutdown Hysteresis			15		$^{\circ}C$
I_{LIM}	N-Channel Current Limit	$V_{IN} = 3.6V$, $L = 2.2\mu H$	3.0			A

- Specifications over the $-40^{\circ}C$ to $+85^{\circ}C$ operating temperature range are assured by design, characterization and correlation with statistical process controls.
- Maximum output power and current is dependent upon operating efficiency and thermal/mechanical design. Output current and output power derating may apply. See Figure 1.
- Total input current with prescribed FB resistor network can be reduced with larger resistor values.

Electrical Characteristics¹

$V_{IN} = 3.6V$, $T_A = -40^{\circ}C$ to $+85^{\circ}C$, unless otherwise noted. Typical values are $T_A = 25^{\circ}C$.

Symbol	Description	Conditions	Min	Typ	Max	Units
SEL, EN/SET						
$V_{SEL(L)}$	SEL Threshold Low	$V_{IN} = 2.7V$			0.4	V
$V_{SEL(H)}$	SEL Threshold High	$V_{IN} = 5.5V$	1.4			V
$V_{EN/SET(L)}$	Enable Threshold Low	$V_{IN} = 2.7V$			0.4	V
$V_{EN/SET(H)}$	Enable Threshold High	$V_{IN} = 5.5V$	1.4			V
$T_{EN/SET LO}$	EN/SET Low Time		0.3		75	μs
$T_{EN/SET HI MIN}$	Minimum EN/SET High Time			50		ns
$T_{EN/SET HI MAX}$	Maximum EN/SET High Time				75	μs
T_{OFF}	EN/SET Off Timeout				500	μs
T_{LAT}	EN/SET Latch Timeout				500	μs
$I_{EN/SET}$	EN/SET Input Leakage		-1		1	μA

1. Specifications over the $-40^{\circ}C$ to $+85^{\circ}C$ operating temperature range are assured by design, characterization and correlation with statistical process controls.

Typical Characteristics

Efficiency vs. Load
($V_{OUT} = 5V$)

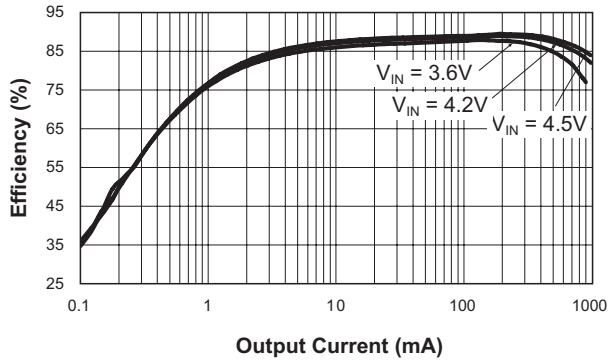

DC Regulation
($V_{OUT} = 5V$)

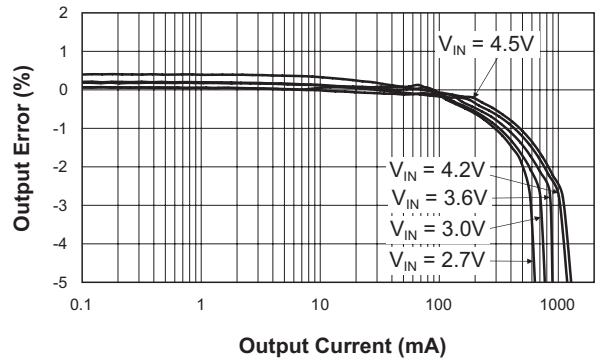

Efficiency vs. Load
($V_{OUT} = 9V$)

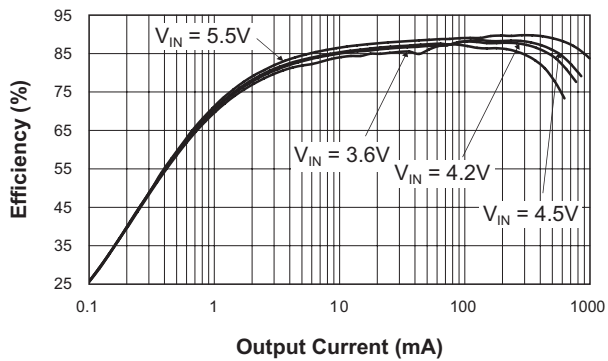

DC Regulation
($V_{OUT} = 9V$)

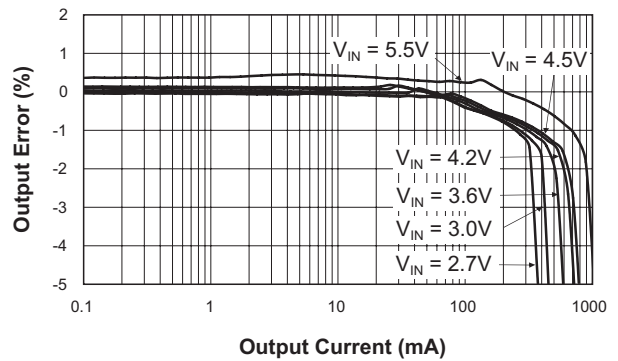

Efficiency vs. Load
($V_{OUT} = 12V$)

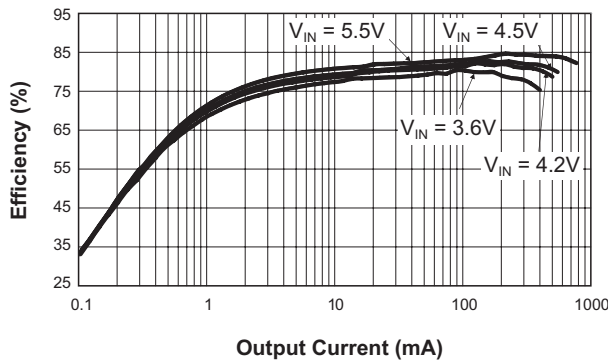

DC Regulation
($V_{OUT} = 12V$)

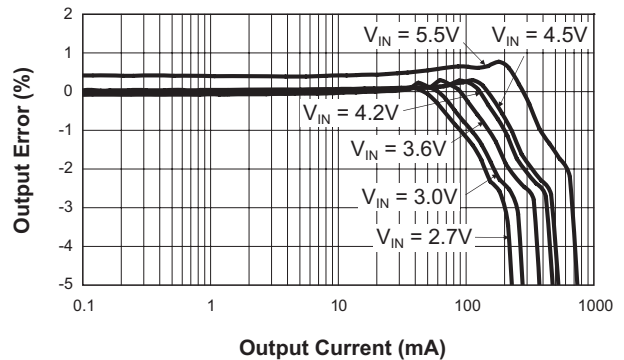

Typical Characteristics

Efficiency vs. Load
($V_{OUT} = 15V$)

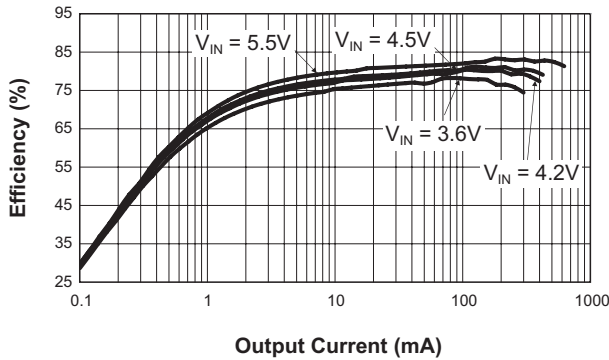

DC Regulation
($V_{OUT} = 15V$)

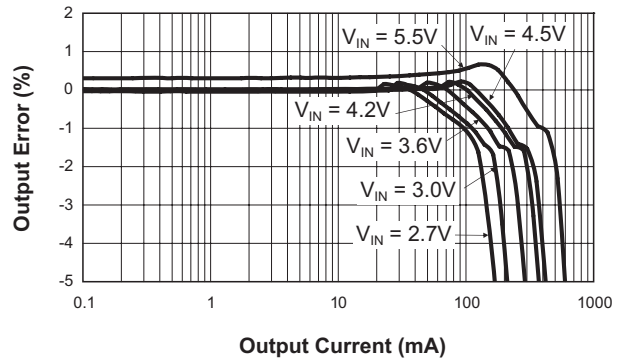

Line Regulation
($V_{OUT} = 12V$)

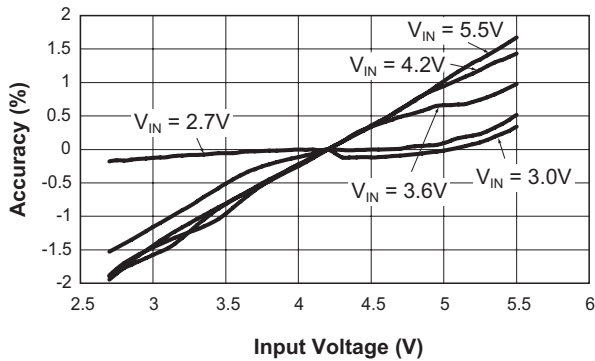

Output Voltage Error vs. Temperature
($V_{IN} = 3.6V$; $V_{OUT} = 12V$; $I_{OUT} = 100mA$)

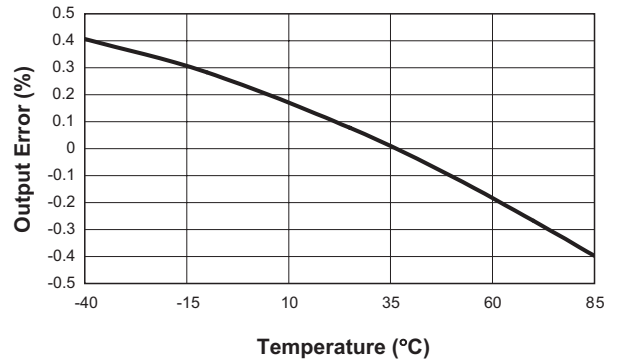

No Load Input Current vs. Input Voltage
($EN = High$)

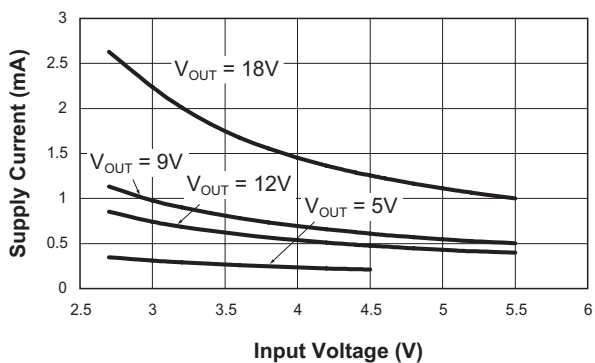

No Load Input Current vs. Temperature
($V_{IN} = 3.6V$; $V_{OUT} = 5V$)

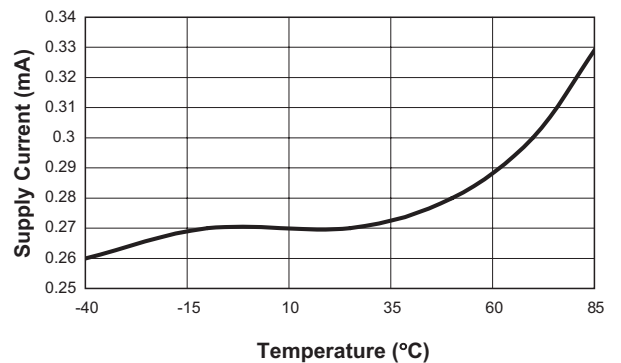

Typical Characteristics

AC Output Ripple vs. Output Current
($V_{OUT} = 9V$)

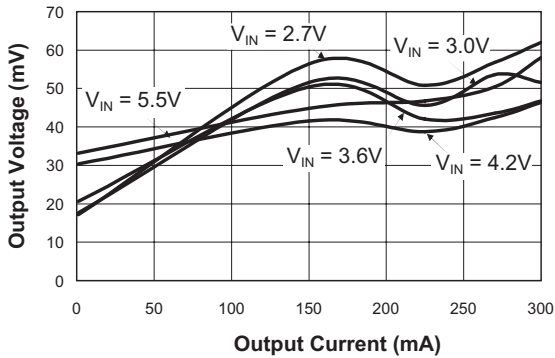

Output Ripple

($V_{IN} = 3.6V$; $V_{OUT} = 15V$; $I_{OUT} = 150mA$; $L = 1.2\mu H$)

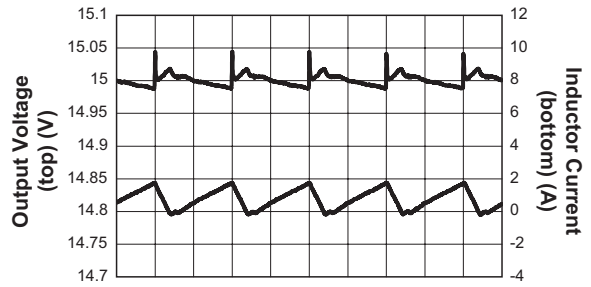

Time (500ns/div)

Output Ripple

($V_{IN} = 3.6V$; $V_{OUT} = 15V$; No Load; $L = 1.2\mu H$)

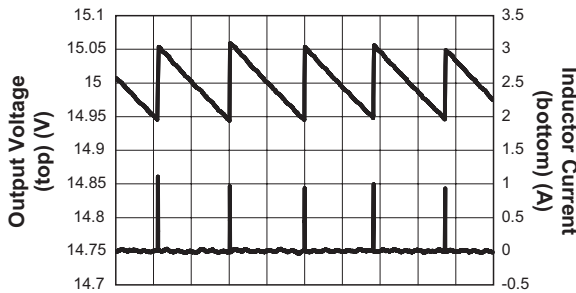

Time (200ns/div)

Load Transient Response

($V_{IN} = 3.6V$; $V_{OUT} = 5V$; $I_{OUT} = 0mA$ to $600mA$)

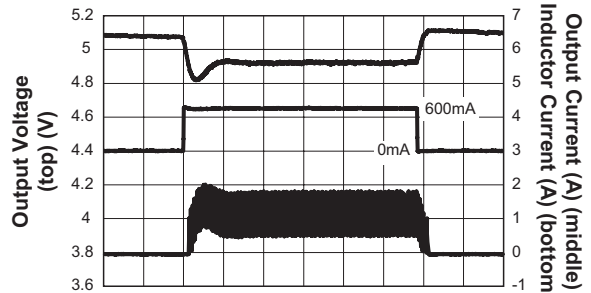

Time (20µs/div)

Load Transient Response

($V_{IN} = 3.6V$; $V_{OUT} = 5V$; $I_{OUT} = 120mA$ to $360mA$)

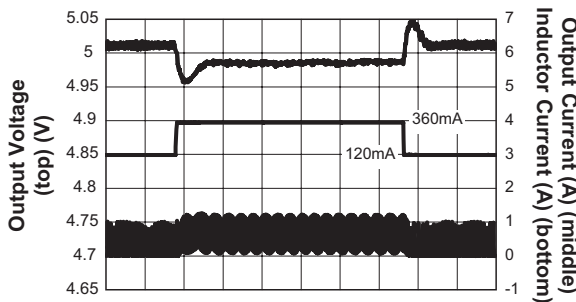

Time (20µs/div)

Load Transient Response

($V_{IN} = 3.6V$; $V_{OUT} = 12V$; $I_{OUT} = 0mA$ to $200mA$)

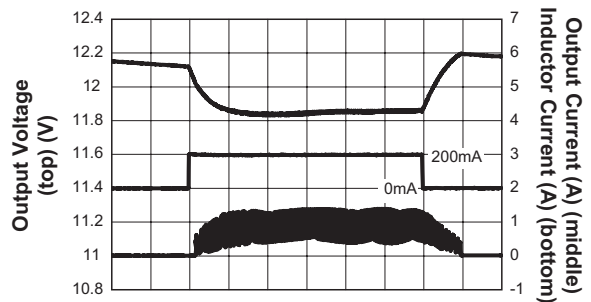

Time (20µs/div)

Typical Characteristics

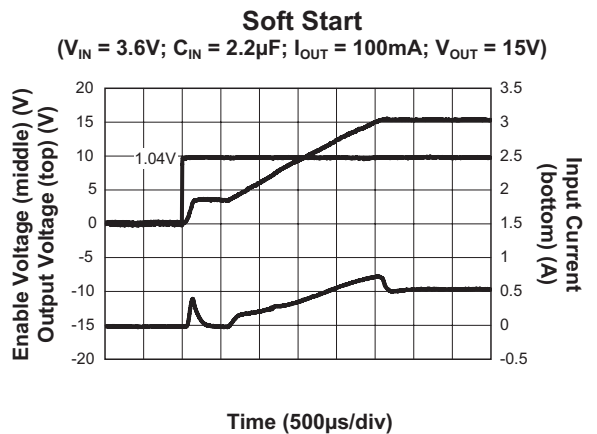
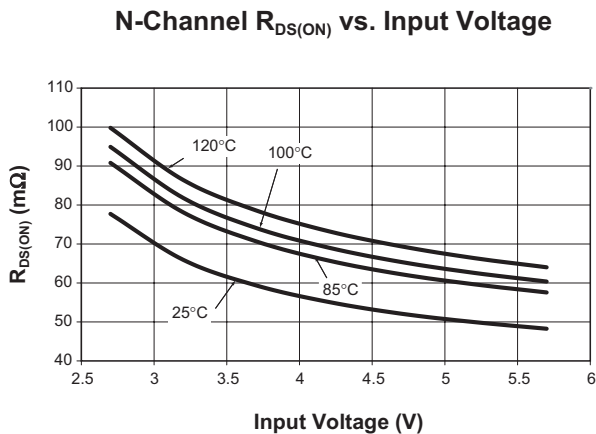
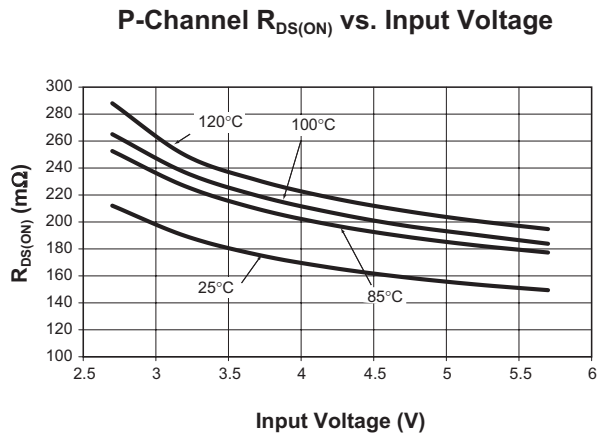
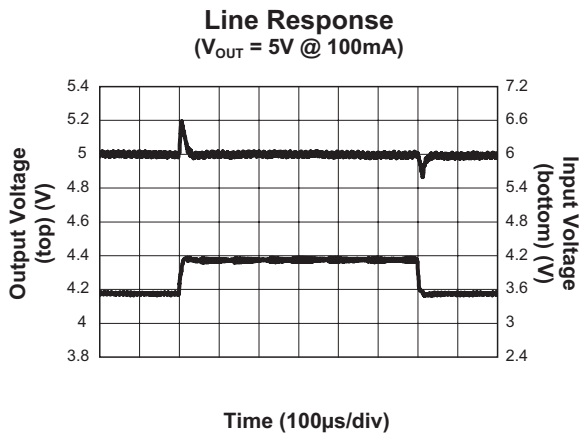
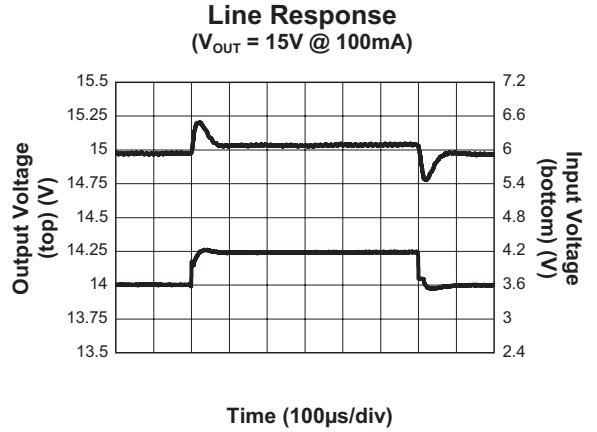
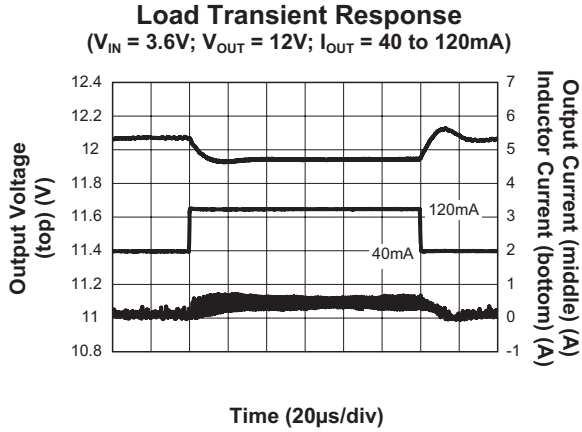

Typical Characteristics

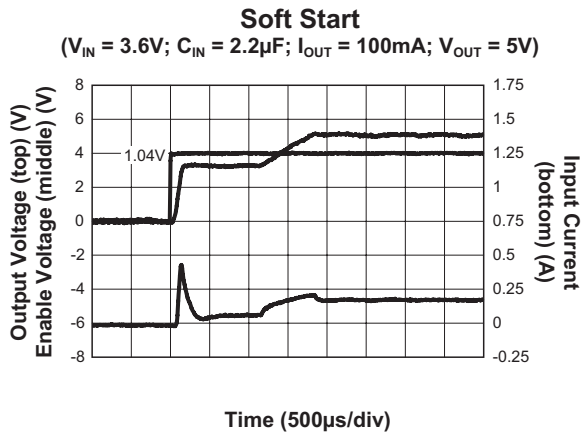

Functional Block Diagram

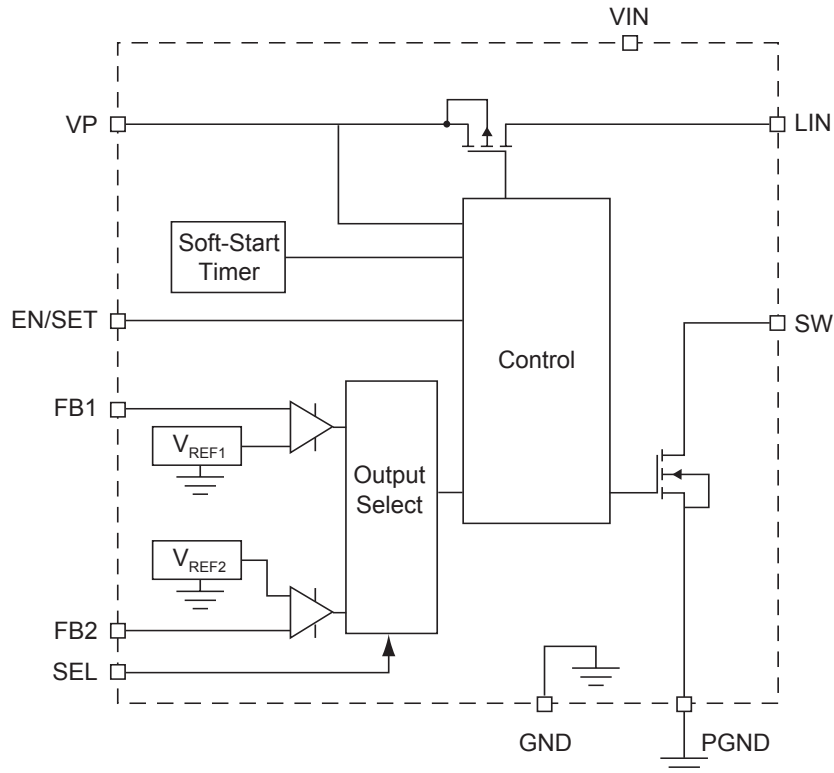

Functional Description

The AAT1210 consists of a DC/DC boost (step-up) controller, an integrated slew rate controlled input disconnect MOSFET switch, and a MOSFET power switch. A high voltage rectifier, power inductor, capacitors and resistor divider network are required to implement a DC/DC boost converter. The minimum output voltage must be 0.5V above the input voltage and the maximum output voltage is 18V. The operating input voltage range is 2.7V to 5.5V.

Control Loop

The AAT1210 provides the benefits of current mode control with a simple hysteretic feedback loop. The device maintains exceptional DC regulation, transient response, and cycle-by-cycle current limit without additional compensation components.

The AAT1210 modulates the power MOSFET switching current in response to changes in output

voltage. This allows the voltage loop to directly program the required inductor current in response to changes in the output load.

The switching cycle initiates when the N-channel MOSFET is turned ON and current ramps up in the inductor. The ON interval is terminated when the inductor current reaches the programmed peak current level. During the OFF interval, the input current decays until the lower threshold, or zero inductor current, is reached. The lower current is equal to the peak current minus a preset hysteresis threshold, which determines the inductor ripple current. The peak current is adjusted by the controller until the output current requirement is met.

The magnitude of the feedback error signal determines the average input current. The AAT1210 controller implements a programmed current source connected to the output capacitor and load resistor. There is no right-half plane zero, and loop stability is achieved with no additional compensation components.

Increased load current results in a drop in the output feedback voltage (FB1 or FB2) sensed through the feedback resistors (R1, R2, R3 in Figure 2). The controller responds by increasing the peak inductor current, resulting in higher average current in the inductor. Alternatively, decreased output load results in an increase in the output feedback voltage. The controller responds by decreasing the peak inductor current, resulting in lower average current in the inductor.

At light load, the inductor OFF interval current goes below zero, which terminates the off period, and the boost converter enters discontinuous mode operation. Further reduction in the load results in a corresponding reduction in the switching frequency. The AAT1210 provides optimized light load operation which reduces switching losses and maintains the highest possible efficiency at light load.

The AAT1210 switching frequency varies with changes in the input voltage, output voltage, and inductor size. Once the boost converter has reached continuous mode, further increases in the output load will not significantly change the operating frequency and constant ripple current in the boost inductor is maintained.

Output Voltage Programming

The FB reference voltage is determined by the logic state of the SEL pin. The output voltage is programmed through a resistor divider network (R1, R2, R3) from the positive output terminal to FB1/FB2 pins to ground. Pulling the SEL pin high activates the FB1 pin which maintains a 1.2V reference voltage, while the FB2 reference is disabled. Pulling the SEL pin low activates the FB2 pin which maintains a 0.6V reference, while the FB1 reference is disabled. The FB1 and FB2 pins may be tied together when a static DC output voltage is desired.

Toggling the SEL pin programs the output voltage between two distinct output voltages across a 2.0X range (maximum). With FB1, FB2 tied together, the output voltage toggles between two voltages with a 2.0X scaling factor. An additional resistor between FB1 and FB2 pins allows toggling between two voltages with a <2.0X scaling factor.

Alternatively, the output voltage may be dynamically programmed to any of 16 voltage levels using the S²Cwire serial digital input. The single-wire S²Cwire interface provides high-speed output voltage programmability across a 2.0X output voltage range. S²Cwire functionality is enabled by pulling the SEL pin low and providing S²Cwire digital clock input to the EN/SET pin which sets the FB2 voltage level from 0.6V to 1.2V. Table 6 details the FB2 reference voltage versus S²Cwire rising clock edges.

Soft Start / Enable

The input disconnect switch is activated when a valid input voltage is present and the EN/SET pin is pulled high. The slew rate control on the P-channel MOSFET ensures minimal inrush current as the output voltage is charged to the input voltage, prior to switching of the N-channel power MOSFET. Monotonic turn-on is guaranteed by the integrated soft-start circuitry.

Soft-start time of approximately 2.5ms is internally programmed to minimize inrush current and eliminate output voltage overshoot across the full input voltage range under all loading conditions.

Current Limit and Over-Temperature Protection

The switching of the N-channel MOSFET terminates if the current limit of 3.0A (minimum) is exceeded. This minimizes power dissipation and component stresses under overload and short-circuit conditions. Switching resumes when the current decays below the current limit.

Thermal protection disables the AAT1210 if internal power dissipation becomes excessive. Thermal protection disables both the N-channel and P-channel MOSFETs. The junction over-temperature threshold is 140°C with 15°C of hysteresis. The output voltage automatically recovers when the over-temperature or over-current fault condition is removed.

Under-Voltage Lockout

Internal bias of all circuits is controlled via the VIN input. Under-voltage lockout (UVLO) guarantees sufficient V_{IN} bias and proper operation of all internal circuitry prior to activation.

Applications Information

Output Current and Power Capability

The AAT1210 boost converter provides a high voltage, high current, regulated DC output voltage from a low voltage DC input. The operating input voltage range is 2.7 to 5.5V.

Figure 1 details the output current and power capability of the AAT1210 for output voltages from 5V to 18V with DC input of 2.7V, 3.6V and 4.5V. The maximum output current/power curves are based on +50°C case temperature rise over ambient using the TDFN34-16 package. Ambient temperature at 25°C, natural convection is assumed. Up to 1.3A of output current is possible with 4.5V input voltage. As shown in Figure 1, the output capability is somewhat reduced at higher output voltage and reduced input voltage.

The AAT1210 schematic and PCB layout are provided in Figures 2, 6, and 7. The PCB layout includes a small 1 ounce copper power plane on top and bottom layers which is tied to the paddle of the TDFN34-16 package. The top plane is soldered directly to the paddle, and tied to the bottom layer

with plated through vias. Details of the PCB layout are provided in Figures 6, 7, and 8.

Actual case temperature may vary and depends on the boost converter efficiency and the system thermal design; including, but not limited to airflow, local heat sources, etc. Additional derating may apply.

Selecting the Output Diode

To ensure minimum forward voltage drop and no recovery, a high voltage Schottky diode is considered the best choice for use with the AAT1210 boost converter. The AAT1210 output diode is sized to maintain acceptable efficiency and reasonable operating junction temperature under full load operating conditions. Forward voltage (V_F) and package thermal resistance (θ_{JA}) are the dominant factors to consider in selecting a diode. The diode's published current rating may not reflect actual operating conditions and should be used only as a comparative measure between similarly rated devices. 20V rated Schottky diodes are recommended for outputs less than 15V, while 30V rated Schottky diodes are recommended for outputs greater than 15V.

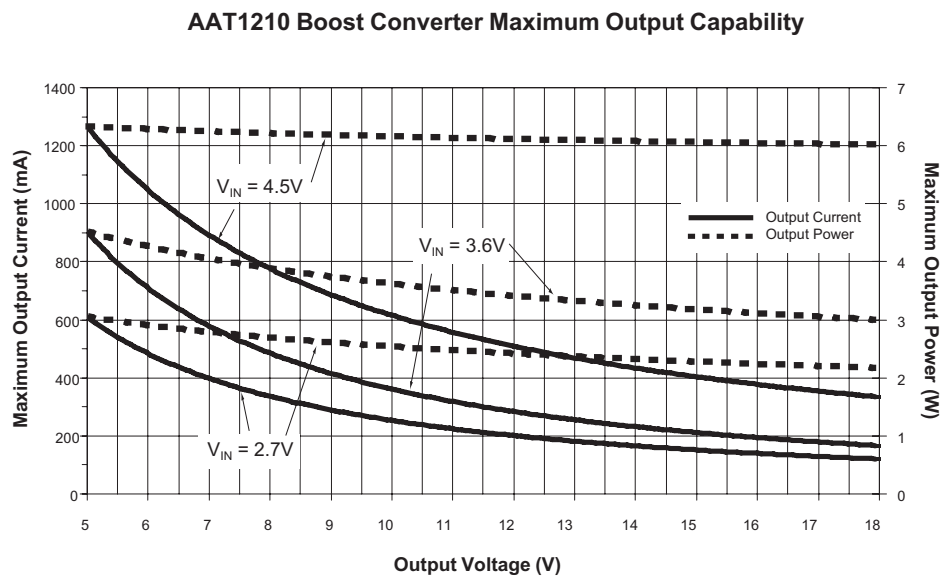
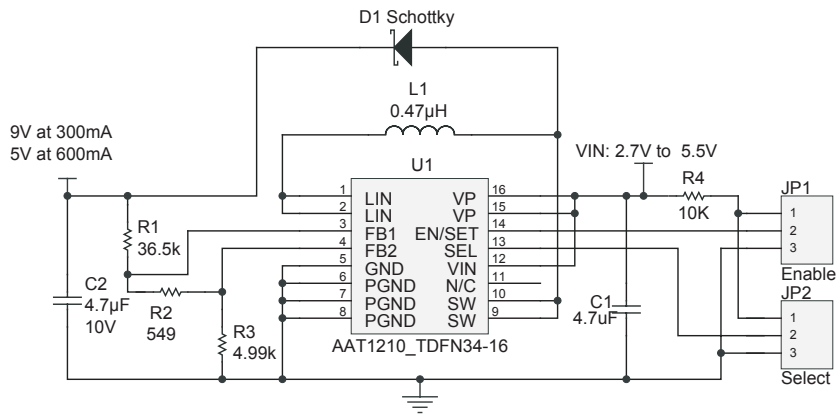

Figure 1: Maximum Output Power Vs. Output Voltage for $T_{C(RISE)} = +50^\circ C$ (assumes TDFN34-16 paddle heatsinking; see Figures 6, 7, and 8).



- U1 AAT1210 TDFN34-16
- C1 6.3V 0603 4.7µF
- C2 10V 0805 10µF
- D1 30V 0.5A MBR0530T1 SOD-123
- L1 0.47µH SD10-R47-R
- R1 36.5k 0603
- R2 549 0603
- R3 4.99k 0603
- R4 10k 0603

Figure 2: AAT1210 Demo Board Schematic.

The switching period is divided between ON and OFF time intervals.

$$\frac{1}{F_s} = T_{ON} + T_{OFF}$$

During the ON time, the N-channel power MOSFET is conducting and storing energy in the boost inductor. During the OFF time, the N-channel power MOSFET is not conducting. Stored energy is transferred from the input supply and boost inductor to the output load through the output diode. Duty cycle is defined as the ON time divided by the total switching interval.

$$D = \frac{T_{ON}}{T_{ON} + T_{OFF}}$$

$$= T_{ON} \cdot F_s$$

The maximum duty cycle can be estimated from the relationship for a continuous mode boost converter. Maximum duty cycle (D_{MAX}) is the duty cycle at minimum input voltage ($V_{IN(MIN)}$).

$$D_{MAX} = \frac{V_{OUT} - V_{IN(MIN)}}{V_{OUT}}$$

The average diode current during the OFF time can be estimated.

$$I_{AVG(OFF)} = \frac{I_{OUT}}{1 - D_{MAX}}$$

The following curves show the V_F characteristics for different Schottky diodes (100°C case). The V_F of the Schottky diode can be estimated from the average current during the off time.

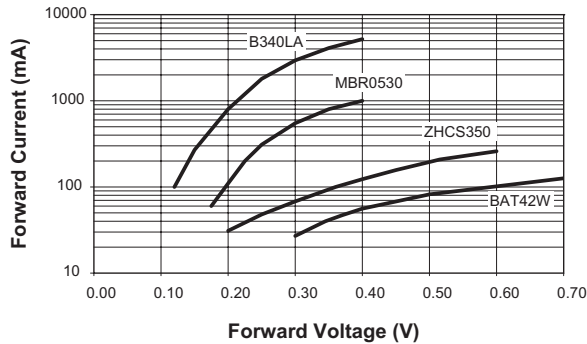

Figure 3: Forward Voltage vs. Forward Current for Various Schottky Diodes.

The average diode current is equal to the output current.

$$I_{AVG(TOT)} = I_{OUT}$$

The average output current multiplied by the forward diode voltage determines the loss of the output diode.

$$P_{LOSS_DIODE} = I_{AVG} \cdot V_F$$

$$= I_{OUT} \cdot V_F$$

Diode junction temperature can be estimated.

$$T_J = T_{AMB} + \theta_{JA} \cdot P_{LOSS_DIODE}$$

The junction temperature should be maintained below 110°C, but may vary depending on application and/or system guidelines. The diode θ_{JA} can be minimized with additional PCB area on the cath-

ode. PCB heatsinking the anode may degrade EMI performance.

The reverse leakage current of the rectifier must be considered to maintain low quiescent (input) current and high efficiency under light load. The rectifier reverse current increases dramatically at high temperatures.

Additional considerations may apply to satisfy short circuit conditions. A short circuit across the output terminals results in high currents through the inductor and output diode. The output diode must be sized to prevent damage and possible failure of the diode under short circuit conditions. The inductor may saturate without incurring damage.

When current limit of (3A minimum) is reached, switching of the low side N-channel MOSFET is disabled. Although switching is disabled, DC current continues to build to a level determined by the DC resistance in the path of current flow. For portable applications, the source resistance (R_{SOURCE}) of the Li-ion battery pack is between 100-300mΩ and should also be considered.

$$I_{SHT-CKT(MAX)} = \frac{(V_{IN(MAX)} - V_F)}{(R_{SOURCE} + R_{DC} + R_{DS(ON)IN})}$$

The AAT1210 controller will generate an over-temperature (OT) event under extended short circuit conditions. OT disables the high side P-channel MOSFET, which terminates current flow in the output diode. Current flow continues when OT hysteresis (cool-down) is met. This continues until the short circuit condition is removed. In portable applications, the battery pack over-current protection may be enabled prior to an OT event.

Manufacturer	Part Number	Rated Forward Current (A)	Non-Repetitive Peak Surge Current (A)	Rated Voltage (V)	Thermal Resistance (θ_{JA} , °C/W)	Case
Diodes, Inc.	BAT42W	0.2	4.0	30	500	SOD-123
ON Semi	MBR0530T	0.5	5.5	30	206	SOD-123
Zetex	ZHCS350	0.35	4.2	40	330	SOD-523
Central Semi	CMDSH2-3	0.2	1.0	30	500	SOD-323

Table 1: Typical Surface Mount Schottky Rectifiers for Various Output Levels.

The diode non-repetitive peak surge current (I_{FSM}) rating should be greater than $I_{SHT_CKT(MAX)}$ to ensure diode reliability under short circuit conditions. Typically, I_{FSM} current is specified for conduction periods from 8-10ms. If short circuit survivability is required, it is recommended to verify $I_{SHT_CKT(MAX)}$ under actual operating conditions across the expected operating temperature range.

Selecting the Boost Inductor

The AAT1210 controller utilizes hysteretic control and the switching frequency varies with output load and input voltage. The value of the inductor determines the maximum switching frequency of the boost converter. Increased output inductance decreases the switching frequency, resulting in higher peak currents and increased output voltage ripple. The required inductance increases with increasing output voltage. The inductor is sized from $0.47\mu H$ to $2.2\mu H$ for output voltages from 5V to 18V. This selection maintains high frequency switching (up to 2MHz), low output ripple and minimum solution size. A summary of recommended inductors and capacitors for 5V to 18V fixed outputs is provided in Table 2.

The physical size of the inductor may be reduced when operating at greater than 2.7V input voltage and/or less than maximum rated output power is desired (see Figure 1 for maximum output power estimate). Figure 4 provides the peak inductor current (I_{PEAK}) versus output power for different input voltage levels. The curves are valid for all output voltages and assume the corresponding inductance value provided in Figure 4. The inductor is selected to maintain I_{PEAK} current less than the specified saturation current (I_{SAT}).

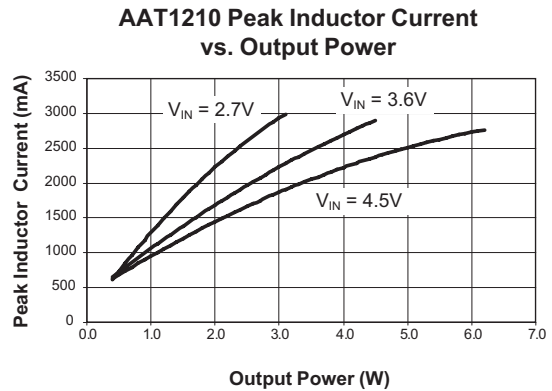

Figure 4: Peak Inductor Current (I_{PEAK}) vs. Output Power.

The RMS current flowing through the boost inductor is equal to the DC plus AC ripple components. Under worst-case RMS conditions, the current waveform is critically continuous. The resulting RMS calculation yields worst-case inductor loss. The RMS value should be compared against the manufacturer's temperature rise, or thermal derating, guidelines.

$$I_{RMS} = \frac{I_{PEAK}}{\sqrt{3}}$$

In most cases, the inductor's specified I_{RMS} current will be greater than the I_{RMS} current required by the boost inductor.

For a given inductor type, smaller inductor size leads to an increase in DCR winding resistance and, in most cases, increased thermal impedance. Winding resistance degrades boost converter efficiency and increases the inductor operating temperature.

$$P_{LOSS_INDUCTOR} = I_{RMS}^2 \cdot DCR$$

V_{OUT}	C1 (Input Capacitor)	C2 (Output Capacitor)	L1 (Boost Inductor)
5.0	4.7 μF	10 μF /6.3V, 10V	0.47 μH
9.0	4.7 μF	10 μF /10V	0.47 μH
12.0	4.7 μF	10 μF /16V	1.0/1.2 μH
15.0	4.7 μF	10 μF /16V	1.0/1.2 μH
18.0	4.7 μF	4.7 μF /25V	2.2 μH

Table 2: Output Inductor and Capacitor Values Vs. Output Voltage

To ensure high reliability, the inductor temperature should not exceed 100°C. Manufacturer's recommendations should be consulted. In some cases, PCB heatsinking applied to the AAT1210 LIN node (non-switching) can improve the inductor's thermal capability. PCB heatsinking may degrade EMI performance when applied to the SW node (switching) of the AAT1210.

Shielded inductors provide decreased EMI and may be required in noise sensitive applications. Unshielded chip inductors provide significant space savings at a reduced cost compared to shielded (wound and gapped) inductors. Chip-type inductors have increased winding resistance when compared to shielded, wound varieties.

Selecting DC/DC Boost Capacitors

Recommended input and output capacitors for output voltages from 5V to 18V are provided in Table 4.

The high output ripple inherent in the boost converter necessitates low impedance output filtering. Multi-layer ceramic (MLC) capacitors provide small size and high capacitance, low parasitic equivalent series resistance (ESR) and equivalent series inductance (ESL), and are well suited for use with the AAT1210 boost regulator. MLC capacitors of type X7R or X5R are recommended to ensure good capacitance stability over the full operating temperature range.

Manufacturer	Part Number	Inductance (μH)	Max DC I _{SAT} Current (A)	Max I _{RMS} Current (A)	DCR (mΩ)	Size LxWxH (mm)	Type
Sumida www.sumida.com	CDRH5D16-1R4	1.4	4.7	4.7	14.6	5.8x5.8x1.8	Shielded
	CDRH5D16-1R4	2.2	3.0	2.85	35.9	5.8x5.8x1.8	Shielded
	CDRH3D11/HP-1R5	1.5	2.0	1.45	80	4.0x4.0x1.2	Shielded
	CDRH3D11/HP-2R7	2.7	1.55	1.3	100	4.0x4.0x1.2	Shielded
Murata www.murata.com	LQH55DNR47M03	0.47	4.8	-	13	5.7x5.0x4.7	Non-Shielded
	LQH55DN1R0M03	1.0	4.0	-	19	5.7x5.0x4.7	Non-Shielded
	LQH55DN1R5M03	1.5	3.7	-	22	5.7x5.0x4.7	Non-Shielded
	LQH55DN2R2M03	2.2	3.2	-	29	5.7x5.0x4.7	Non-Shielded
Cooper www.cooperet.com	SD3814-R47	0.47	4.44	2.81	20	4.0x4.0x1.4	Shielded
	SD3814-1R2	1.2	2.67	1.85	46	4.0x4.0x1.4	Shielded
	SD3814-2R2	2.2	1.9	1.43	77	4.0x4.0x1.4	Shielded
	SD10-R47-R	0.47	3.54	2.59	24.9	5.2x5.2x1.0	Shielded
	SD10-1R0-R	1	2.25	1.93	44.8	5.2x5.2x1.0	Shielded
	SD10-2R2-R	2.2	1.65	1.35	91.2	5.2x5.2x1.0	Shielded
	SD18-2R2-R	2.2	2.16	2.55	39.8	5.2x5.2x1.8	Shielded

Table 3: Recommended Inductors.

Manufacturer	Part Number	Value (μF)	Voltage Rating (V)	Temp. Co.	Case Size
Murata www.murata.com	GRM188R60J475KEAD	4.7	6.3	X5R	0603
	GRM21BR61A475KA73L	4.7	10	X5R	0805
	GRM21BR61E475KA12L	4.7	25	X5R	0805
	GRM188R60J106ME47D	10	6.3	X5R	0603
	GRM21BR61A106KE19L	10	10	X5R	0805
	GRM219R61A106KE44D	10	10	X5R	0805 (H = 0.85mm)
	GRM21BR61C106KE15L	10	16	X5R	0805

Table 4: Recommended MLC Capacitors.

The output capacitor is sized to maintain the output load without significant voltage droop (ΔV_{OUT}) during the power switch ON interval, when the output diode is not conducting. A ceramic output capacitor from 4.7 μ F to 10 μ F is recommended. Output capacitors should be rated from 10V to 25V, depending on the maximum desired output voltage. Ceramic capacitors sized as small as 0603 are available which meet these requirements.

Minimum 6.3V rated ceramic capacitors are required at the input. Ceramic capacitors sized as small as 0603 are available which meet these requirements. Output capacitors should be rated from 6.3V to 25V, depending on the maximum desired output voltage.

MLC capacitors exhibit significant capacitance reduction with applied voltage. Output ripple measurements should confirm that output voltage droop and converter stability is acceptable. Voltage derating can minimize this factor, but results may vary with package size and among specific manufacturers.

Output capacitor size can be estimated at a switching frequency (F_{SW}) of 500kHz (worst-case).

$$C_{OUT} = \frac{I_{OUT} \cdot D_{MAX}}{F_S \cdot \Delta V_{OUT}}$$

The boost converter input current flows during both ON and OFF switching intervals. The input ripple current is less than the output ripple and, as a result, less input capacitance is required. A ceramic output capacitor from 4.7 μ F to 10 μ F is recommended. The voltage rating of the capacitor must be greater than, or equal to, the maximum operating output voltage. X5R ceramic capacitors are available in 6.3V, 10V, 16V and 25V rating. Ceramic capacitors sized as small as 0603 are available which meet these requirements.

Minimum 6.3V rated ceramic capacitors are required at the input. Ceramic capacitors sized as small as 0603 are available which meet these requirements.

Setting the Output Voltage

The minimum output voltage must be greater than the specified maximum input voltage plus 0.5V margin to maintain proper operation of the AAT1210 boost converter. The output voltage may be programmed through a resistor divider network located from the output to FB1 and FB2 pins to ground. Pulling the SEL pin high activates the FB1 pin which maintains a 1.2V reference voltage, while the FB2 reference is disabled. Pulling the SEL pin low activates the FB2 pin which maintains a 0.6V reference, while the FB1 reference is disabled.

The AAT1210 output voltage can be programmed by one of three methods. First, the output voltage can be static by pulling the SEL logic pin either high or low. Second, the output voltage can be dynamically adjusted between two pre-set levels within a 2X operating range by toggling the SEL logic pin. Third, the output can be dynamically adjusted to any of 16 preset levels within a 2X operating range using the integrated S²Cwire single wire interface via the EN/SET pin. See Table 5 for static and dynamic output voltage settings.

Table 5 provides details of resistor values for common output voltages from 5V to 18V for SEL = High and SEL = Low options. SEL = High corresponds to $V_{OUT(1)}$ and SEL = Low corresponds to $V_{OUT(2)}$.

Option 1: Static Output Voltage

Most DC/DC boost converter applications require a static (fixed) output voltage. If a static voltage is desired, the FB1 pin should be connected directly to FB2 and a resistor between FB1 and FB2 pins is not required.

A static output voltage can be configured by pulling the SEL either high or low. SEL pin high activates the FB1 reference pin to 1.2V (nominal). Alternatively, the SEL pin is pulled low to activate the FB2 reference at 0.6V (nominal). Table 5 provides details of resistor values for common output voltages from 5V to 18V for SEL = High and SEL = Low options.

Option 2: Dynamic Voltage Control Using SEL Pin

The output may be dynamically adjusted between two output voltages by toggling the SEL logic pin. Output voltages $V_{OUT(1)}$ and $V_{OUT(2)}$ correspond to the two output references, FB1 and FB2. Pulling the SEL logic pin high activates $V_{OUT(1)}$, while pulling the SEL logic pin low activates $V_{OUT(2)}$.

In addition, the ratio of output voltages $V_{OUT(2)}/V_{OUT(1)}$ is always less than 2.0, corresponding to a 2X (maximum) programmable range.

Option 3: Dynamic Voltage Control Using S²Cwire Interface

The output can be dynamically adjusted by the host controller to any of 16 pre-set output voltage levels using the integrated S²Cwire interface. The EN/SET pin serves as the S²Cwire interface input. The SEL pin must be pulled low when using the S²Cwire interface.

S²Cwire Serial Interface

AnalogicTech's S²Cwire serial interface is a proprietary high-speed single-wire interface. The S²Cwire interface records rising edges of the EN/SET input and decodes into 16 different states. Each state corresponds to a voltage setting on the FB2 pin, as shown in Table 6.

S²Cwire Output Voltage Programming

The AAT1210 is programmed through the S²Cwire interface according to Table 6. The rising clock edges received through the EN/SET pin determine the feedback reference and output voltage set-point. Upon power-up with the SEL pin low and prior to S²Cwire programming, the default feedback reference voltage is set to 0.6V.

$V_{OUT(1)}$ (SEL = High)	$V_{OUT(2)}$ (SEL = Low)	R3 = 4.99k Ω	
		R1 (k Ω)	R2 (k Ω)
5.0V	-	15.8	0
6.0V	-	20.0	0
7.0V	-	24.3	0
8.0V	-	28.0	0
9.0V	-	32.4	0
10.0V	-	36.5	0
12.0V	-	44.2	0
15.0V	-	57.6	0
16.0V	-	61.9	0
18.0V	-	69.8	0
-	5.0V	36.5	0
-	6.0V	45.3	0
-	7.0V	53.6	0
-	8.0V	61.9	0
-	9.0V	69.8	0
-	10.0V	78.7	0
-	12.0V	95.3	0
-	15.0V	121	0
-	16.0V	127	0
-	18.0V	143	0
9.0V	5.0V	36.5	0.549
10.0V	9.0V	66.5	4.02
12.0V	10.0V	75	3.32
15.0V	10.0V	76.8	1.65
15.0V	12.0V	90.9	3.01
16.0V	10.0V	76.8	1.24
18.0V	10.0V	78.7	0.562
15.0V	12.0V	90.9	3.01
16.0V	12.0V	93.1	2.49
18.0V	12.0V	93.1	1.65
18.0V	15.0V	115	3.32

Table 5: SEL Pin Voltage Control Resistor Values (1% resistor tolerance).

EN/SET Rising Edges	FB2 Reference Voltage (V)	EN/SET Rising Edges	FB2 Reference Voltage (V)
1	0.60 (Default)	9	0.92
2	0.64	10	0.96
3	0.68	11	1.00
4	0.72	12	1.04
5	0.76	13	1.08
6	0.80	14	1.12
7	0.84	15	1.16
8	0.88	16	1.20

Table 6: S²Cwire Voltage Control Settings (SEL = Low).

S²Cwire Serial Interface Timing

The S²Cwire serial interface has flexible timing. Data can be clocked-in at speeds up to 1MHz. After data has been submitted, EN/SET is held high to latch the data for a period T_{LAT} . The output is subsequently changed to the predetermined voltage. When EN/SET is set low for a time greater than T_{OFF} , the AAT1210 is disabled. When disabled, the register is reset to the default value, which sets the FB2 pin to 0.6V if EN is subsequently pulled high.

PCB Layout

Boost converter performance can be adversely affected by poor layout. Possible impact includes high input and output voltage ripple, poor EMI performance, and reduced operating efficiency. Every

attempt should be made to optimize the layout in order to minimize parasitic PCB effects (stray resistance, capacitance, inductance) and EMI coupling from the high frequency SW node.

A suggested PCB layout for the AAT1210 boost converter is shown in Figures 6, 7, and 8. The following PCB layout guidelines should be considered:

1. Minimize the distance from Capacitor C1 and C2 negative terminal to the PGND pins. This is especially true with output capacitor C2, which conducts high ripple current from the output diode back to the PGND pins.
2. Place the feedback resistors close to the output terminals. Route the output pin directly to resistor R1 to maintain good output regulation. R3 should be routed close to the output GND pin, but should not share a significant return path with output capacitor C2.
3. Minimize the distance between L1 to D1 and switching pin SW; minimize the size of the PCB area connected to the SW pin.
4. Maintain a ground plane and connect to the IC PGND pin(s) as well as the GND terminals of C1 and C2.
5. Consider additional PCB area on D1 cathode to maximize heatsinking capability. This may be necessary when using a diode with a high V_F and/or thermal resistance.
6. To maximize thermal capacity, connect the exposed paddle to the top and bottom power planes using plated through vias. Top and bottom planes should not extend far beyond the TDFN34-16 package boundary to minimize stray EMI.

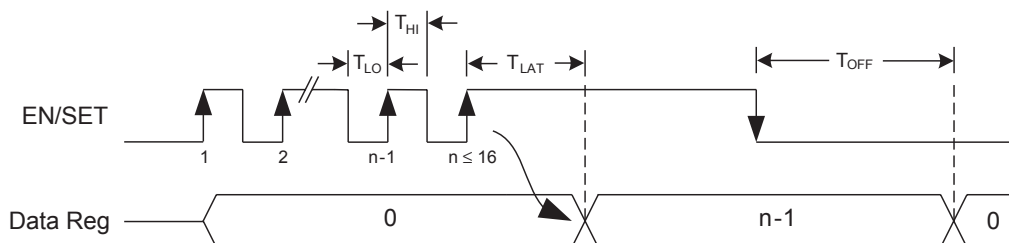

Figure 5: S²Cwire Timing Diagram.

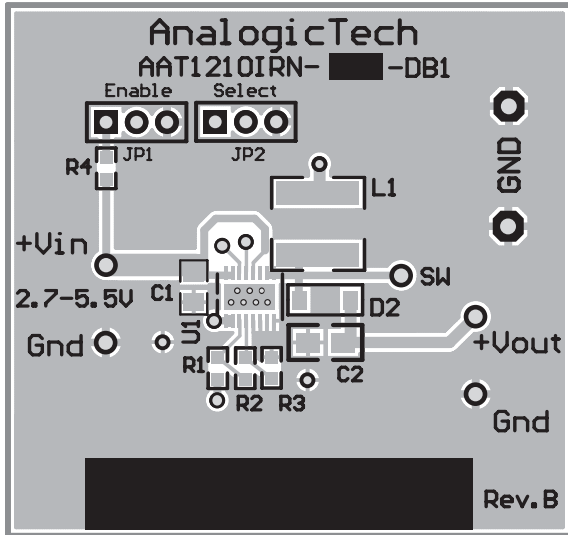

Figure 6: AAT1210 Evaluation Board
Top Side Layout.

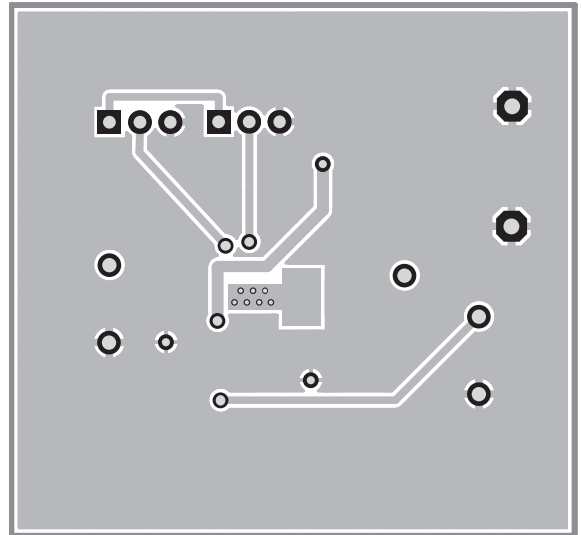

Figure 7: AAT1210 Evaluation Board
Bottom Side Layout.

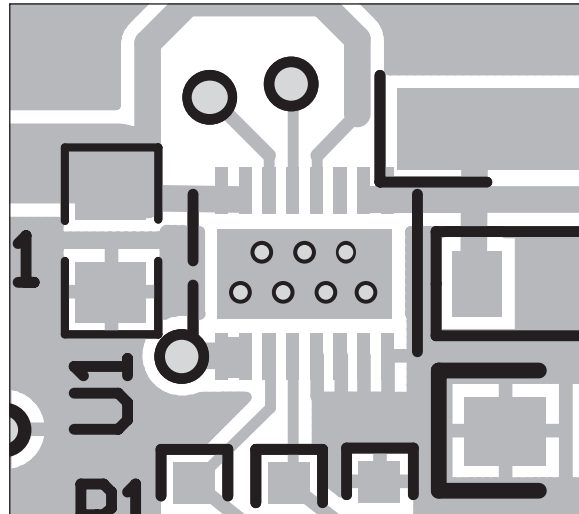

Figure 8: Exploded View of AAT1210 Evaluation Board
Top Side Layout Detailing Plated Through Vias.

Ordering Information

Package	Marking ¹	Part Number (Tape and Reel) ²
TDFN34-16	V D X Y Y	AAT1210IRN-0.6-T1



All AnalogicTech products are offered in Pb-free packaging. The term “Pb-free” means semiconductor products that are in compliance with current RoHS standards, including the requirement that lead not exceed 0.1% by weight in homogeneous materials. For more information, please visit our website at <http://www.analogictech.com/pbfree>.

Package Information³

TDFN34-16

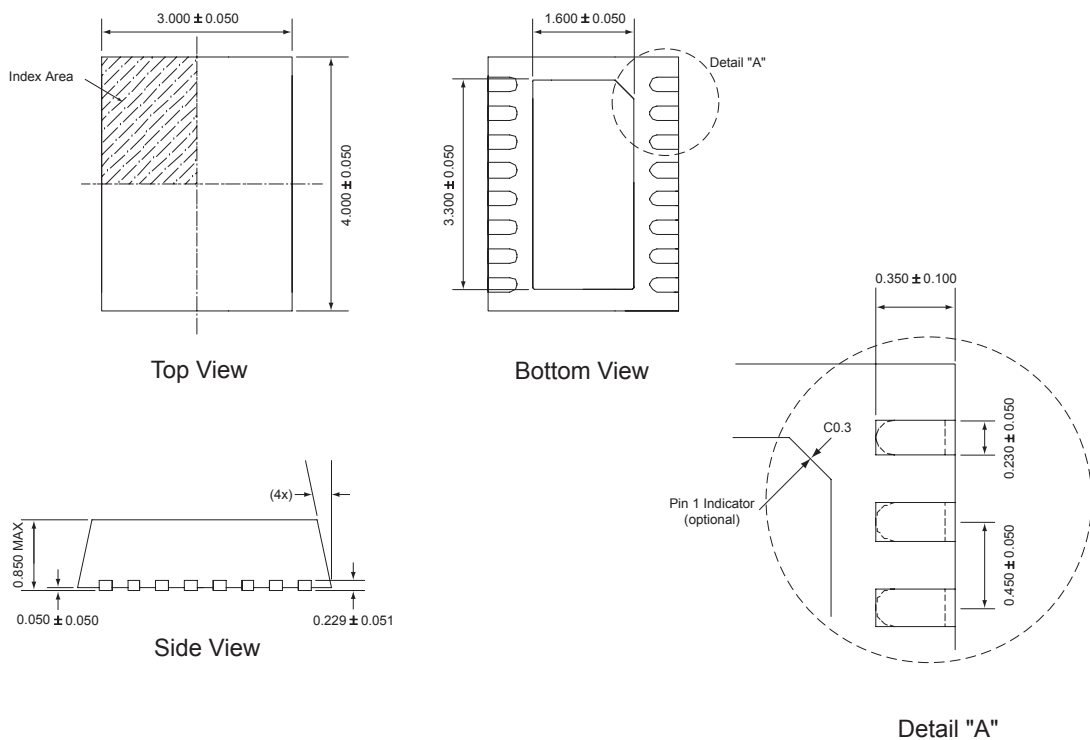

All dimensions in millimeters.

1. XYY = assembly and date code.
2. Sample stock is generally held on part numbers listed in **BOLD**.
3. The leadless package family, which includes QFN, TQFN, DFN, TDFN and STDFN, has exposed copper (unplated) at the end of the lead terminals due to the manufacturing process. A solder fillet at the exposed copper edge cannot be guaranteed and is not required to ensure a proper bottom solder connection.



AAT1210

High Power DC/DC Boost Converter with Optional Dynamic Voltage Programming

© Advanced Analogic Technologies, Inc.

AnalogicTech cannot assume responsibility for use of any circuitry other than circuitry entirely embodied in an AnalogicTech product. No circuit patent licenses, copyrights, mask work rights, or other intellectual property rights are implied. AnalogicTech reserves the right to make changes to their products or specifications or to discontinue any product or service without notice. Customers are advised to obtain the latest version of relevant information to verify, before placing orders, that information being relied on is current and complete. All products are sold subject to the terms and conditions of sale supplied at the time of order acknowledgement, including those pertaining to warranty, patent infringement, and limitation of liability. AnalogicTech warrants performance of its semiconductor products to the specifications applicable at the time of sale in accordance with AnalogicTech's standard warranty. Testing and other quality control techniques are utilized to the extent AnalogicTech deems necessary to support this warranty. Specific testing of all parameters of each device is not necessarily performed.

AnalogicTech and the AnalogicTech logo are trademarks of Advanced Analogic Technologies Incorporated. All other brand and product names appearing in this document are registered trademarks or trademarks of their respective holders.

Advanced Analogic Technologies, Inc.
830 E. Arques Avenue, Sunnyvale, CA 94085
Phone (408) 737-4600
Fax (408) 737-4611

