

# FMW-2206

Schottky Barrier Rectifier

Mar. 2008

## General Description

FMW-2206 is a Schottky Barrier Diode, and has achieved low leakage current and low VF by selecting the best barrier metal.

## Applications

- DC-DC converters
- AC adapter
- High frequency rectification circuit

## Features

- Super-high speed & low noise switching.
- Low forward voltage drop.

## Package

TO220F(3Pin)

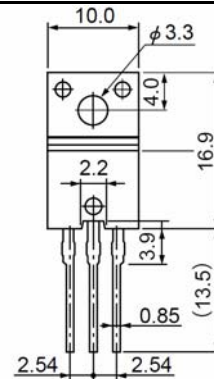

## Key Specifications

Symbol	Unit	Rating	Conditions
$V_{RM}$	V	60	
$V_F$	V	0.70	$I_F=10A$
$I_{F(AV)}$	A	20	

## Typical Characteristics

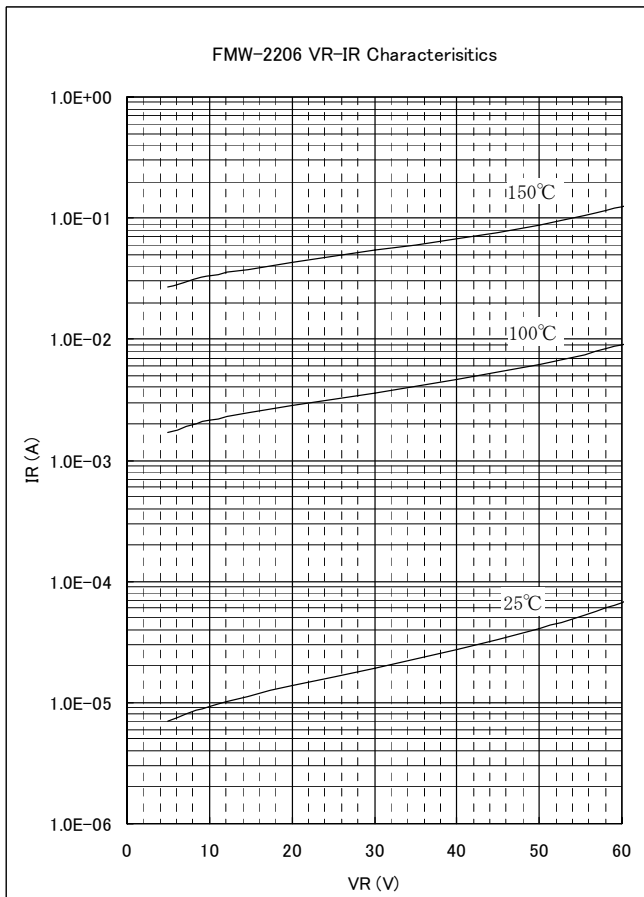
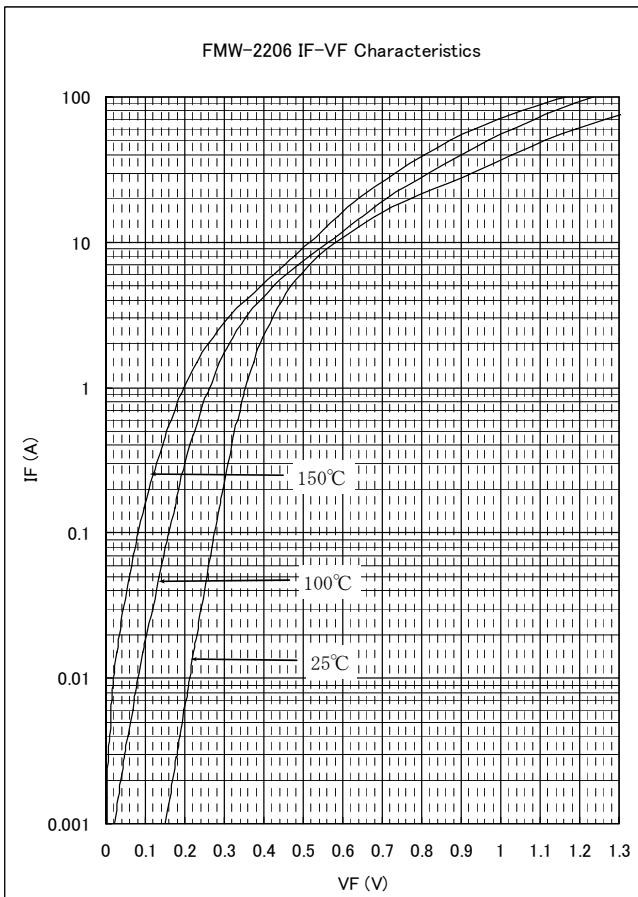

The information included herein is believed to be accurate and reliable. However, SANKEN ELECTRIC CO., LTD assumes no responsibility for its use ; nor for any infringements of patents or other rights of third parties that may result from its use.

# FMW-2206

Mar. 2008

Schottky Barrier Rectifier

**\* Absolute maximum ratings**

No.	Parameter	Symbol	Unit	Rating	Conditions
1	Transient Peak Reverse Voltage	$V_{RSM}$	V	60	
2	Peak Reverse Voltage	$V_{RM}$	V	60	
3	Average Forward Current	$I_{F(AV)}$	A	20	
4	Peak Surge Forward Current	$I_{FSM}$	A	120	Half sinewave, one shot
5	$I^2t$ Limiting Value	$I^2t$	$A^2s$	72	$1msec < t < 10msec$
6	Junction Temperature	$T_j$	$^{\circ}C$	-40 to +150	
7	Storage Temperature	$T_{stg}$	$^{\circ}C$	-40 to +150	

No.1,2,4&5 show ratings per one chip.

**\* Electrical characteristics (Ta=25°C, unless otherwise specified)**

No.	Parameter	Symbol	Unit	Rating	Conditions
1	Forward Voltage Drop	$V_F$	V	0.70 max.	$I_F=10A$
2	Reverse Leakage Current	$I_R$	mA	1.0 max.	$V_R=V_{RM}$
3	Reverse Leakage Current Under High Temperature	$H \cdot I_R$	mA	250 max.	$V_R=V_{RM}, T_j=150^{\circ}C$
4	Thermal Resistance	$R_{th(j-c)}$	$^{\circ}C/W$	4.0 max.	Between Junction and Case

No.1,2,&3 show characteristics per one chip.

The information included herein is believed to be accurate and reliable. However, SANKEN ELECTRIC CO., LTD assumes no responsibility for its use ; nor for any infringements of patents or other rights of third parties that may result from its use.

**FMW-2206**

Schottky Barrier Rectifier

Mar. 2008

★ Characteristics

Forward Power Dissipation

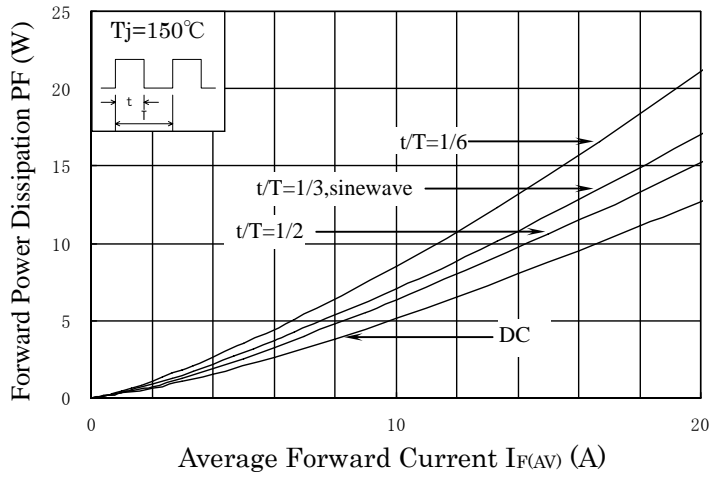

Reverse Power Dissipation

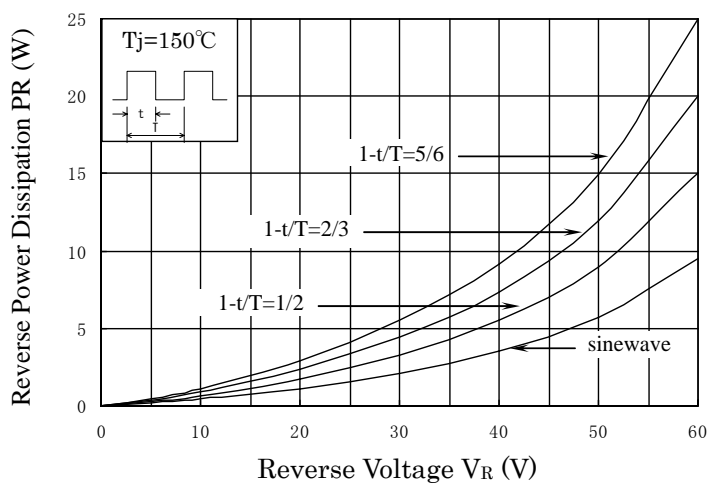

Current Derating  $V_R=60\text{V}$

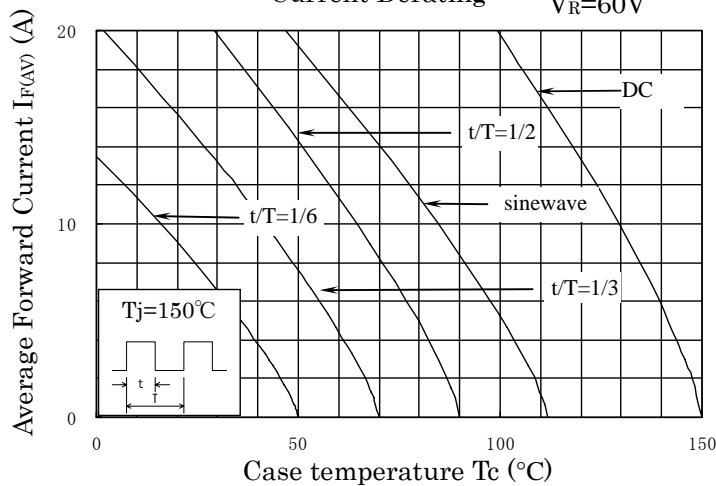

**FMW-2206**

Schottky Barrier Rectifier

Mar. 2008

★ Outline drawings, mm

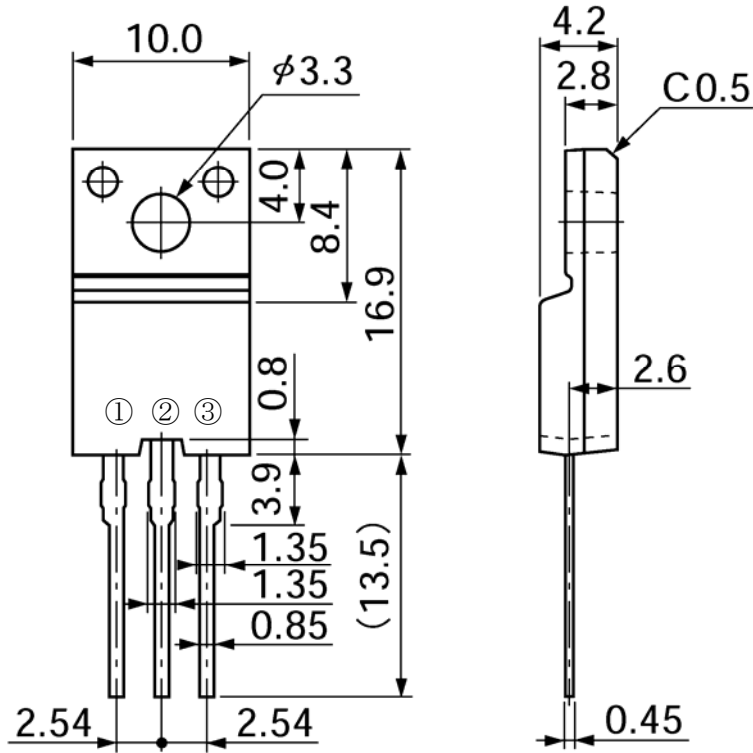

tolerance:±0.2

★ Connection Diagram

