

# Frequency Synthesizer

KSN-1100A-119+

50Ω 1095.4 to 1100.6 MHz

## The Big Deal

- Low phase noise and spurious
- Robust design and construction
- Small size 0.80" x 0.58" x 0.15"



CASE STYLE: DK1042

## Product Overview

The KSN-1100A-119+ is a Frequency Synthesizer, designed to operate from 1095.4 to 1100.6 MHz for block converter application. The KSN-1100A-119+ is packaged in a metal case (size of 0.80" x 0.58" x 0.15") to shield against unwanted signals and noise.

## Key Features

Feature	Advantages
Low phase noise and spurious: <ul style="list-style-type: none"><li>• Phase Noise: -105 dBc/Hz typ. @ 10 kHz offset</li><li>• Comparison Spurious: -91 dBc typ.</li><li>• Reference Spurious: -105 dBc typ.</li></ul>	Low phase noise and spurious improve system EVM (Error Vector Magnitude).
Robust design and construction	To enhance the robustness of KSN-1100A-119+, each internal component is secured to the substrate with chip bonder, thereby eliminating the risk of tombstoning during subsequent solder reflow operations by the customer.
Small size, 0.80" x 0.58" x 0.15"	The small size enables the KSN-1100A-119+ to be used in compact designs.



IF/RF MICROWAVE COMPONENTS • ISO 9001 ISO 14001 AS9100 CERTIFIED RoHS compliant

P.O. Box 350166, Brooklyn, New York 11235-0003 (718) 934-4500 Fax (718) 332-4661



The Design Engineers Search Engine finds the model you need, Instantly • For detailed performance specs & shopping online see



Notes: 1. Performance and quality attributes and conditions not expressly stated in this specification sheet are intended to be excluded and do not form a part of this specification sheet. 2. Electrical specifications and performance data contained herein are based on Mini-Circuit's applicable established test performance criteria and measurement instructions. 3. The parts covered by this specification sheet are subject to Mini-Circuits standard limited warranty and terms and conditions (collectively, "Standard Terms"); Purchasers of this part are entitled to the rights and benefits contained therein. For a full statement of the Standard Terms and the exclusive rights and remedies thereunder, please visit Mini-Circuits' website at [www.minicircuits.com/MCLStore/terms.jsp](http://www.minicircuits.com/MCLStore/terms.jsp).

50Ω 1095.4 to 1100.6 MHz

### Features

- Integrated VCO + PLL
- Low phase noise and spurious
- Robust design and construction
- Low operating voltage (VCC VCO=+5V, VCC PLL=+3V)
- Small size 0.80" x 0.58" x 0.15"

### Applications

- Block converter

### General Description

The KSN-1100A-119+ is a Frequency Synthesizer, designed to operate from 1095.4 to 1100.6 MHz for block converter application. The KSN-1100A-119+ is packaged in a metal case (size of 0.80" x 0.58" x 0.15") to shield against unwanted signals and noise. To enhance the robustness of KSN-1100A-119+, each internal component is secured to the substrate with chip bonder, thereby eliminating the risk of tombstoning during subsequent solder reflow operations by the customer.



CASE STYLE: DK1042  
PRICE: \$29.95 ea. QTY (1-9)

+ RoHS compliant in accordance with EU Directive (2002/95/EC)

The +Suffix has been added in order to identify RoHS Compliance. See our web site for RoHS Compliance methodologies and qualifications.

### Simplified Schematic



IF/RF MICROWAVE COMPONENTS • ISO 9001 ISO 14001 AS9100 CERTIFIED RoHS compliant  
P.O. Box 350166, Brooklyn, New York 11235-0003 (718) 934-4500 Fax (718) 332-4661



The Design Engineers Search Engine finds the model you need, Instantly • For detailed performance specs & shopping online see



Notes: 1. Performance and quality attributes and conditions not expressly stated in this specification sheet are intended to be excluded and do not form a part of this specification sheet. 2. Electrical specifications and performance data contained herein are based on Mini-Circuit's applicable established test performance criteria and measurement instructions. 3. The parts covered by this specification sheet are subject to Mini-Circuits standard limited warranty and terms and conditions (collectively, "Standard Terms"); Purchasers of this part are entitled to the rights and benefits contained therein. For a full statement of the Standard Terms and the exclusive rights and remedies thereunder, please visit Mini-Circuits' website at [www.minicircuits.com/MCLStore/terms.jsp](http://www.minicircuits.com/MCLStore/terms.jsp).

**Electrical Specifications** (over operating temperature -40°C to +85°C)

Parameters	Test Conditions	Min.	Typ.	Max.	Units
Frequency Range	-	1095.4	-	1100.6	MHz
Step Size	-	-	200	-	kHz
Settling Time	Within ± 1 kHz	-	2	-	mSec
Output Power	-	0	+3	+6	dBm
SSB Phase Noise	@ 100 Hz offset	-	-89	-	dBc/Hz
	@ 1 kHz offset	-	-87	-80	
	@ 10 kHz offset	-	-105	-101	
	@ 100 kHz offset	-	-134	-129	
	@ 1 MHz offset	-	-154	-148	
Reference Spurious Suppression	Ref. Freq. 104 MHz	-	-105	-80	dBc
Comparison Spurious Suppression	Step Size 200 kHz	-	-91	-75	
Non - Harmonic Spurious Suppression	-	-	-90	-	
Harmonic Suppression	-	-	-37	-28	
VCO Supply Voltage	+5.00	+4.75	+5.00	+5.25	
PLL Supply Voltage	+3.00	+2.85	+3.00	+3.15	
VCO Supply Current	-	-	38	47	mA
PLL Supply Current	-	-	9	16	
Reference Input (External)	Frequency	104 (square wave)	-	104	MHz
	Amplitude	1	-	1	V <sub>P-P</sub>
	Input impedance	-	-	100	KΩ
	Phase Noise @ 1 kHz offset	-	-	-135	dBc/Hz
RF Output port Impedance	-	-	50	-	Ω
Input Logic Level	Input high voltage	-	2.55	-	V
	Input low voltage	-	-	0.55	V
Digital Lock Detect	Locked	-	2.45	-	3.15
	Unlocked	-	-	-	0.40
Frequency Synthesizer PLL	-	ADF4106			
PLL Programming	-	3-wire serial 3V CMOS			
Register Map @ 1100.6 MHz	F_Register	-	(MSB) 01011111100000010010011 (LSB)		
	N_Register	-	(MSB) 001000010101011100111101 (LSB)		
	R_Register	-	(MSB) 00000000000100000100000 (LSB)		

**Absolute Maximum Ratings**

Parameters	Ratings
VCO Supply Voltage	5.8V
PLL Supply Voltage	3.6V
VCO Supply Voltage to PLL Supply Voltage	-0.3V to +5.8V
Reference Frequency Voltage	-0.3Vmin, VCC PLL +0.3Vmax
Data, Clock, LE Levels	-0.3Vmin, VCC PLL +0.3Vmax
Operating Temperature	-40°C to +85°C
Storage Temperature	-55°C to +100°C

Permanent damage may occur if any of these limits are exceeded



IF/RF MICROWAVE COMPONENTS • ISO 9001 ISO 14001 AS9100 CERTIFIED RoHS compliant  
 P.O. Box 350166, Brooklyn, New York 11235-0003 (718) 934-4500 Fax (718) 332-4661

The Design Engineers Search Engine finds the model you need, Instantly • For detailed performance specs & shopping online see [minicircuits.com](http://minicircuits.com)

Notes: 1. Performance and quality attributes and conditions not expressly stated in this specification sheet are intended to be excluded and do not form a part of this specification sheet. 2. Electrical specifications and performance data contained herein are based on Mini-Circuit's applicable established test performance criteria and measurement instructions. 3. The parts covered by this specification sheet are subject to Mini-Circuits standard limited warranty and terms and conditions (collectively, "Standard Terms"); Purchasers of this part are entitled to the rights and benefits contained therein. For a full statement of the Standard Terms and the exclusive rights and remedies thereunder, please visit Mini-Circuits' website at [www.minicircuits.com/MCLStore/terms.jsp](http://www.minicircuits.com/MCLStore/terms.jsp).

Typical Performance Data

FREQUENCY (MHz)	POWER OUTPUT (dBm)			VCO CURRENT (mA)			PLL CURENT (mA)		
	-45°C	+25°C	+85°C	-45°C	+25°C	+85°C	-45°C	+25°C	+85°C
	1095.4	3.15	3.27	3.30	37.88	39.81	40.97	8.43	9.29
1097.0	3.13	3.26	3.29	37.87	39.80	40.97	8.44	9.30	10.86
1100.6	3.11	3.23	3.26	37.84	39.77	40.95	8.44	9.30	10.87

FREQUENCY (MHz)	HARMONICS (dBc)					
	F2			F3		
	-45°C	+25°C	+85°C	-45°C	+25°C	+85°C
1095.4	-40.43	-40.92	-41.91	-35.09	-37.22	-39.49
1097.0	-40.84	-41.28	-42.29	-34.56	-36.81	-39.15
1100.6	-41.50	-42.10	-43.23	-33.77	-36.11	-38.50

FREQUENCY (MHz)	PHASE NOISE (dBc/Hz) @OFFSETS				
	+25°C				
	100Hz	1kHz	10kHz	100kHz	1MHz
1095.4	-89.13	-87.50	-105.34	-133.79	-153.82
1097.0	-89.15	-89.16	-105.65	-134.05	-154.15
1100.6	-90.20	-88.33	-105.30	-134.24	-154.46

FREQUENCY (MHz)	PHASE NOISE (dBc/Hz) @OFFSETS				
	-45°C				
	100Hz	1kHz	10kHz	100kHz	1MHz
1095.4	-86.88	-85.70	-105.64	-132.90	-152.84
1097.0	-88.81	-84.48	-105.94	-132.85	-152.94
1100.6	-87.52	-84.79	-106.31	-132.88	-153.40

FREQUENCY (MHz)	PHASE NOISE (dBc/Hz) @OFFSETS				
	+85°C				
	100Hz	1kHz	10kHz	100kHz	1MHz
1095.4	-91.34	-87.81	-104.89	-133.95	-153.42
1097.0	-88.11	-86.13	-104.63	-134.24	-154.75
1100.6	-87.06	-86.45	-105.21	-134.29	-154.92



IF/RF MICROWAVE COMPONENTS • ISO 9001 ISO 14001 AS9100 CERTIFIED RoHS compliant  
 P.O. Box 350166, Brooklyn, New York 11235-0003 (718) 934-4500 Fax (718) 332-4661



The Design Engineers Search Engine finds the model you need, Instantly • For detailed performance specs & shopping online see



Notes: 1. Performance and quality attributes and conditions not expressly stated in this specification sheet are intended to be excluded and do not form a part of this specification sheet. 2. Electrical specifications and performance data contained herein are based on Mini-Circuit's applicable established test performance criteria and measurement instructions. 3. The parts covered by this specification sheet are subject to Mini-Circuits standard limited warranty and terms and conditions (collectively, "Standard Terms"); Purchasers of this part are entitled to the rights and benefits contained therein. For a full statement of the Standard Terms and the exclusive rights and remedies thereunder, please visit Mini-Circuits' website at [www.minicircuits.com/MCLStore/terms.jsp](http://www.minicircuits.com/MCLStore/terms.jsp).

COMPARISON SPURIOUS ORDER	COMPARISON SPURIOUS @Fcarrier 1095.4MHz+(n*Fcomparison) (dBc) note 1			COMPARISON SPURIOUS @Fcarrier 1098MHz+(n*Fcomparison) (dBc) note 1			COMPARISON SPURIOUS @Fcarrier 1100.6MHz+(n*Fcomparison) (dBc) note 1			
	n	-45°C	+25°C	+85°C	-45°C	+25°C	+85°C	-45°C	+25°C	+85°C
	-5	-104.04	-108.57	-102.07	-105.41	-108.85	-101.67	-101.79	-106.76	-101.34
-4	-102.81	-107.31	-100.49	-100.89	-106.25	-100.39	-99.79	-105.93	-99.27	
-3	-99.02	-104.09	-97.29	-98.28	-105.36	-98.26	-96.81	-103.24	-95.59	
-2	-93.43	-98.28	-92.40	-93.42	-99.18	-93.25	-92.86	-97.09	-91.21	
-1	-84.42	-92.47	-85.23	-85.07	-89.93	-85.64	-87.48	-87.95	-84.45	
0 note 2	-	-	-	-	-	-	-	-	-	
+1	-85.99	-96.04	-85.53	-85.80	-92.12	-86.00	-89.67	-91.78	-84.09	
+2	-98.37	-102.31	-95.40	-97.61	-100.94	-94.13	-95.79	-100.16	-92.51	
+3	-103.63	-107.96	-97.92	-100.48	-106.44	-99.33	-100.15	-107.60	-96.56	
+4	-106.20	-109.07	-101.44	-104.53	-110.17	-102.22	-102.30	-111.82	-99.12	
+5	-111.28	-111.14	-102.96	-109.14	-115.74	-103.39	-103.56	-111.83	-101.43	

Note 1: Comparison frequency 200 kHz

Note 2: All spurs are referenced to carrier signal (n=0).

REFERENCE SPURIOUS ORDER	REFERENCE SPURIOUS @Fcarrier 1095.4MHz+(n*Freference) (dBc) note 3			REFERENCE SPURIOUS @Fcarrier 1098MHz+(n*Freference) (dBc) note 3			REFERENCE SPURIOUS @Fcarrier 1100.6MHz+(n*Freference) (dBc) note 3			
	n	-45°C	+25°C	+85°C	-45°C	+25°C	+85°C	-45°C	+25°C	+85°C
	-5	-110.16	-113.88	-127.46	-109.86	-113.32	-128.59	-108.26	-111.59	-122.08
-4	-104.11	-106.14	-105.63	-103.68	-105.97	-106.22	-103.79	-105.93	-105.87	
-3	-90.66	-93.84	-95.98	-90.85	-94.22	-96.25	-90.85	-94.11	-96.00	
-2	-102.77	-102.77	-102.63	-103.10	-103.25	-102.87	-103.53	-103.35	-102.60	
-1	-118.06	-112.19	-110.68	-117.69	-113.95	-111.95	-118.22	-114.43	-113.05	
0 note 4	-	-	-	-	-	-	-	-	-	
+1	-97.39	-98.36	-97.06	-97.54	-98.36	-97.05	-97.80	-98.39	-97.33	
+2	-100.99	-102.47	-102.73	-101.15	-102.42	-102.91	-100.88	-102.43	-102.93	
+3	-95.33	-99.13	-102.54	-95.49	-99.39	-102.59	-95.50	-99.37	-102.41	
+4	-111.73	-115.12	-116.41	-111.46	-114.92	-116.59	-111.67	-115.63	-116.23	
+5	-124.85	-127.06	-129.79	-124.70	-126.80	-129.21	-124.82	-126.45	-131.34	

Note 3: Reference frequency 104 MHz

Note 4: All spurs are referenced to carrier signal (n=0).



IF/RF MICROWAVE COMPONENTS • ISO 9001 ISO 14001 AS9100 CERTIFIED RoHS compliant  
 P.O. Box 350166, Brooklyn, New York 11235-0003 (718) 934-4500 Fax (718) 332-4661



The Design Engineers Search Engine finds the model you need, Instantly • For detailed performance specs & shopping online see



Notes: 1. Performance and quality attributes and conditions not expressly stated in this specification sheet are intended to be excluded and do not form a part of this specification sheet. 2. Electrical specifications and performance data contained herein are based on Mini-Circuit's applicable established test performance criteria and measurement instructions. 3. The parts covered by this specification sheet are subject to Mini-Circuits standard limited warranty and terms and conditions (collectively, "Standard Terms"); Purchasers of this part are entitled to the rights and benefits contained therein. For a full statement of the Standard Terms and the exclusive rights and remedies thereunder, please visit Mini-Circuits' website at [www.minicircuits.com/MCLStore/terms.jsp](http://www.minicircuits.com/MCLStore/terms.jsp).

Typical Performance Curves

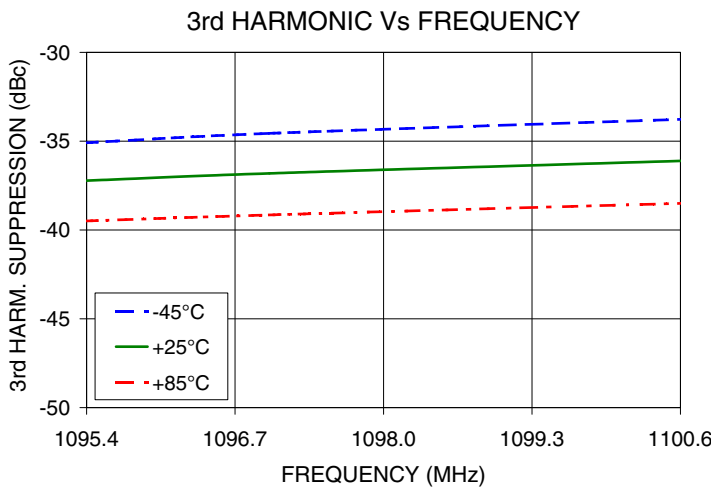
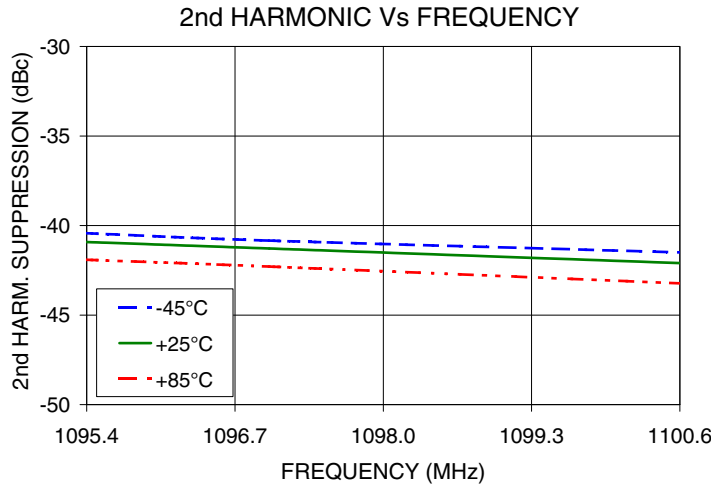
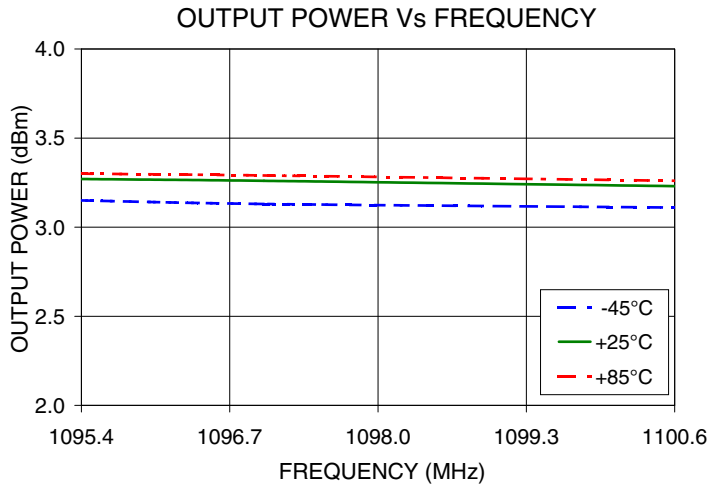

IF/RF MICROWAVE COMPONENTS • ISO 9001 ISO 14001 AS9100 CERTIFIED RoHS compliant  
 P.O. Box 350166, Brooklyn, New York 11235-0003 (718) 934-4500 Fax (718) 332-4661



The Design Engineers Search Engine finds the model you need, Instantly • For detailed performance specs & shopping online see



Notes: 1. Performance and quality attributes and conditions not expressly stated in this specification sheet are intended to be excluded and do not form a part of this specification sheet. 2. Electrical specifications and performance data contained herein are based on Mini-Circuit's applicable established test performance criteria and measurement instructions. 3. The parts covered by this specification sheet are subject to Mini-Circuits standard limited warranty and terms and conditions (collectively, "Standard Terms"); Purchasers of this part are entitled to the rights and benefits contained therein. For a full statement of the Standard Terms and the exclusive rights and remedies thereunder, please visit Mini-Circuits' website at [www.minicircuits.com/MCLStore/terms.jsp](http://www.minicircuits.com/MCLStore/terms.jsp).

PHASE NOISE @100Hz offset

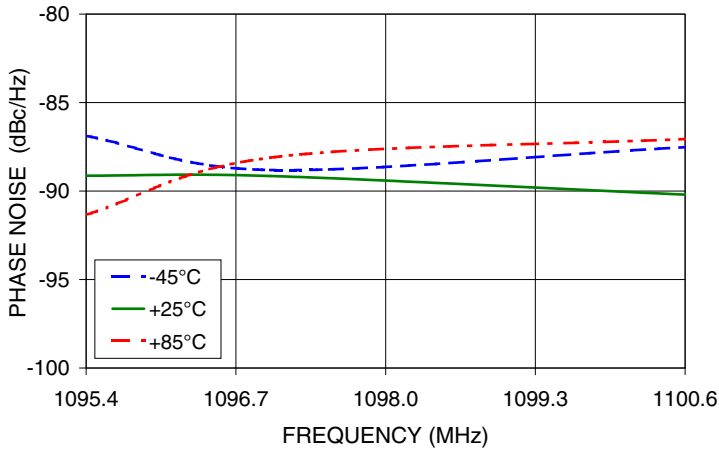

PHASE NOISE @1kHz offset

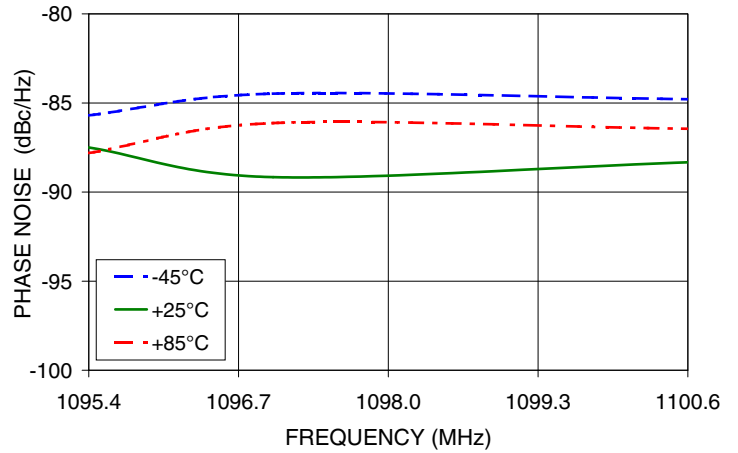

PHASE NOISE @10 kHz offset

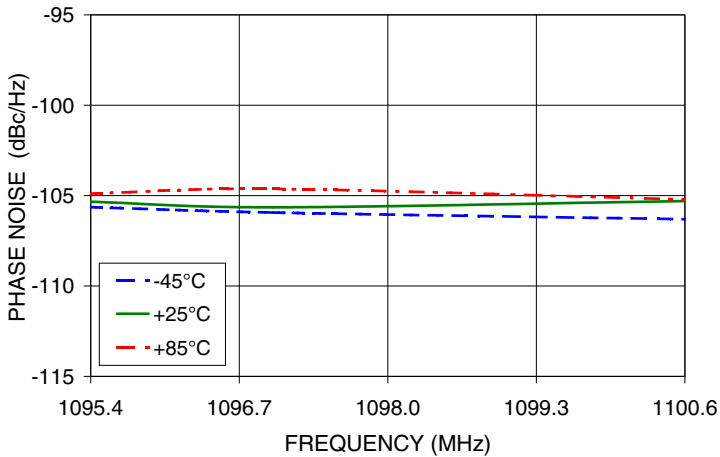

PHASE NOISE @100kHz offset

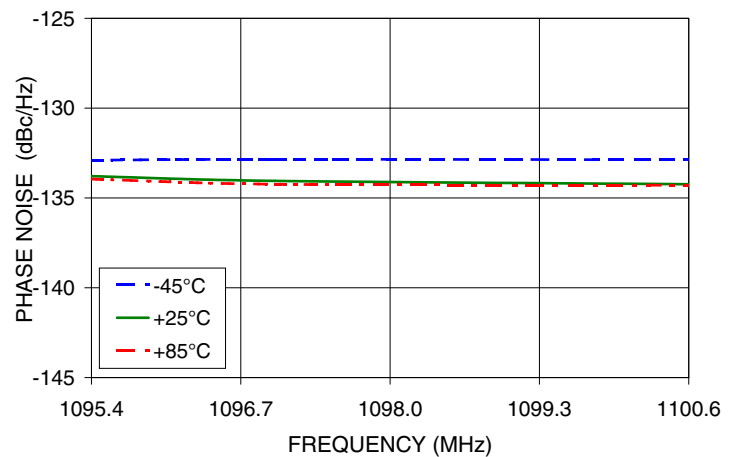

PHASE NOISE @1MHz offset

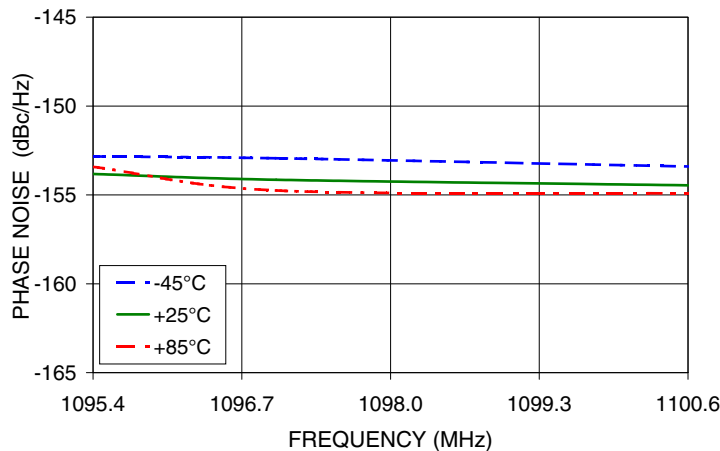

IF/RF MICROWAVE COMPONENTS • ISO 9001 ISO 14001 AS9100 CERTIFIED RoHS compliant  
 P.O. Box 350166, Brooklyn, New York 11235-0003 (718) 934-4500 Fax (718) 332-4661



The Design Engineers Search Engine finds the model you need, Instantly • For detailed performance specs & shopping online see



Notes: 1. Performance and quality attributes and conditions not expressly stated in this specification sheet are intended to be excluded and do not form a part of this specification sheet. 2. Electrical specifications and performance data contained herein are based on Mini-Circuit's applicable established test performance criteria and measurement instructions. 3. The parts covered by this specification sheet are subject to Mini-Circuits standard limited warranty and terms and conditions (collectively, "Standard Terms"); Purchasers of this part are entitled to the rights and benefits contained therein. For a full statement of the Standard Terms and the exclusive rights and remedies thereunder, please visit Mini-Circuits' website at [www.minicircuits.com/MCLStore/terms.jsp](http://www.minicircuits.com/MCLStore/terms.jsp).

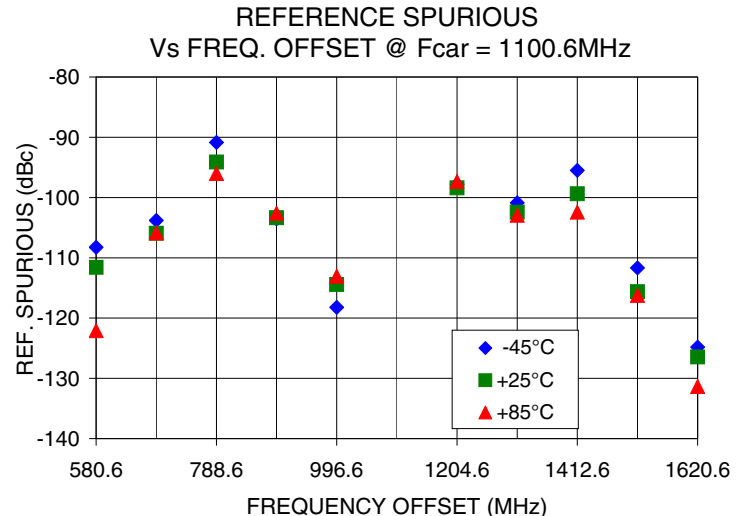
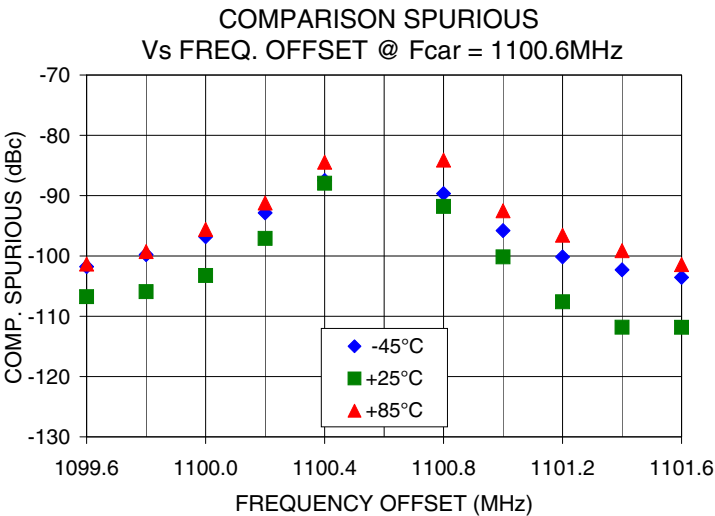
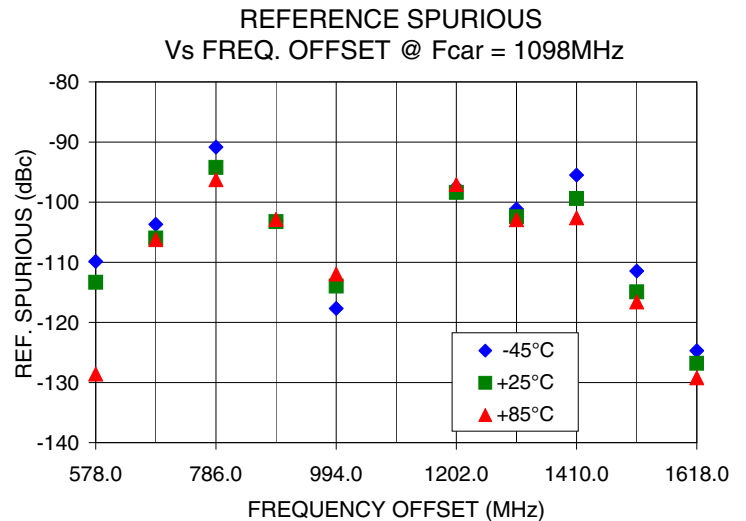
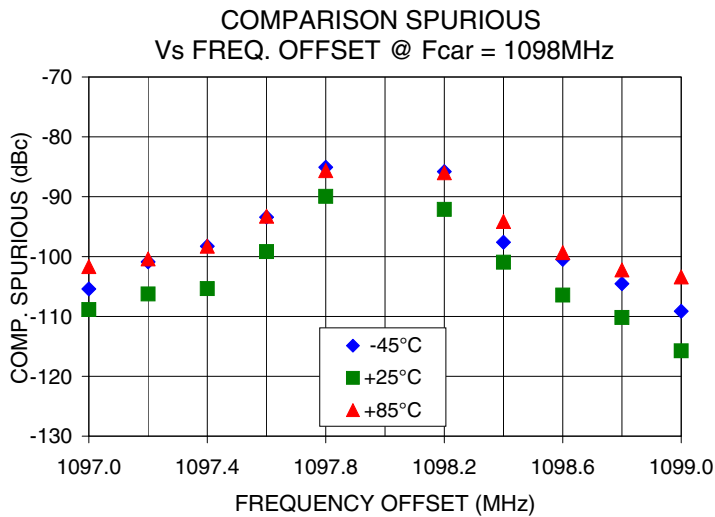
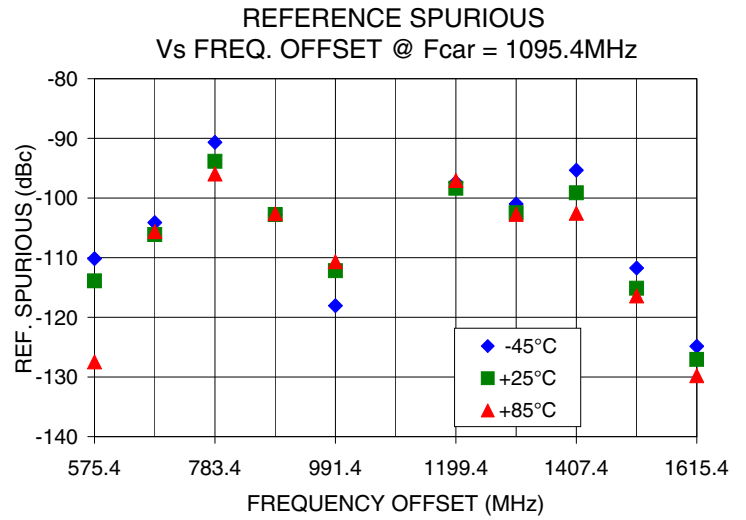
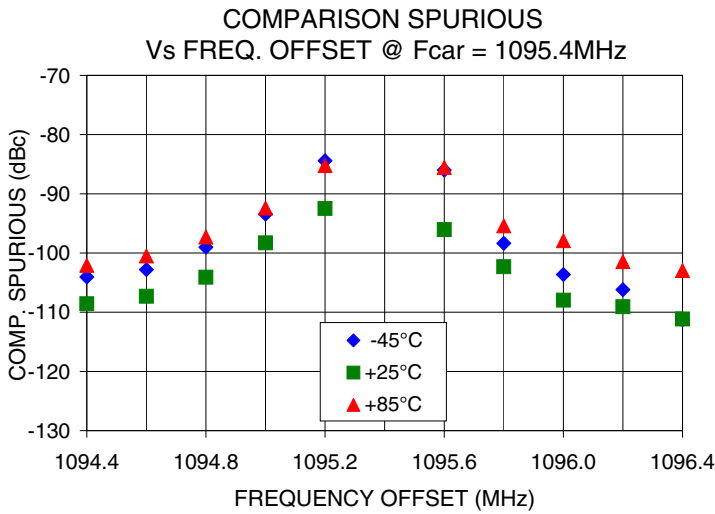

IF/RF MICROWAVE COMPONENTS • ISO 9001 ISO 14001 AS9100 CERTIFIED RoHS compliant  
P.O. Box 350166, Brooklyn, New York 11235-0003 (718) 934-4500 Fax (718) 332-4661



The Design Engineers Search Engine finds the model you need, Instantly • For detailed performance specs & shopping online see



Notes: 1. Performance and quality attributes and conditions not expressly stated in this specification sheet are intended to be excluded and do not form a part of this specification sheet. 2. Electrical specifications and performance data contained herein are based on Mini-Circuit's applicable established test performance criteria and measurement instructions. 3. The parts covered by this specification sheet are subject to Mini-Circuits standard limited warranty and terms and conditions (collectively, "Standard Terms"); Purchasers of this part are entitled to the rights and benefits contained therein. For a full statement of the Standard Terms and the exclusive rights and remedies thereunder, please visit Mini-Circuits' website at [www.minicircuits.com/MCLStore/terms.jsp](http://www.minicircuits.com/MCLStore/terms.jsp).



Pin Configuration

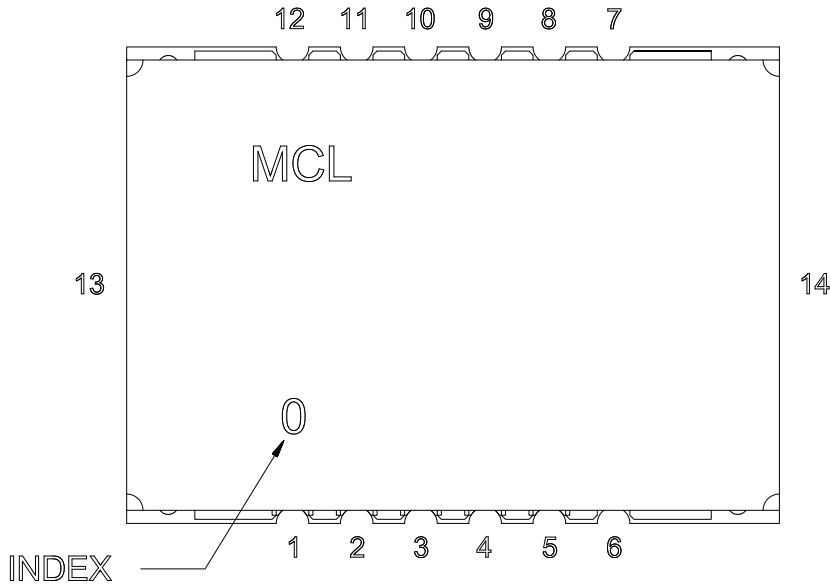

Pin Connection

Pin Number	Function
1	VCC PLL
2	GND
3	REF IN
4	GND
5	VCC VCO
6	GND
7	RF OUT
8	GND
9	LOCK DET
10	CLOCK
11	DATA
12	LE
13	GND
14	GND

Recommended Application Circuit

Note: REF IN and RF OUT ports are internally AC coupled.

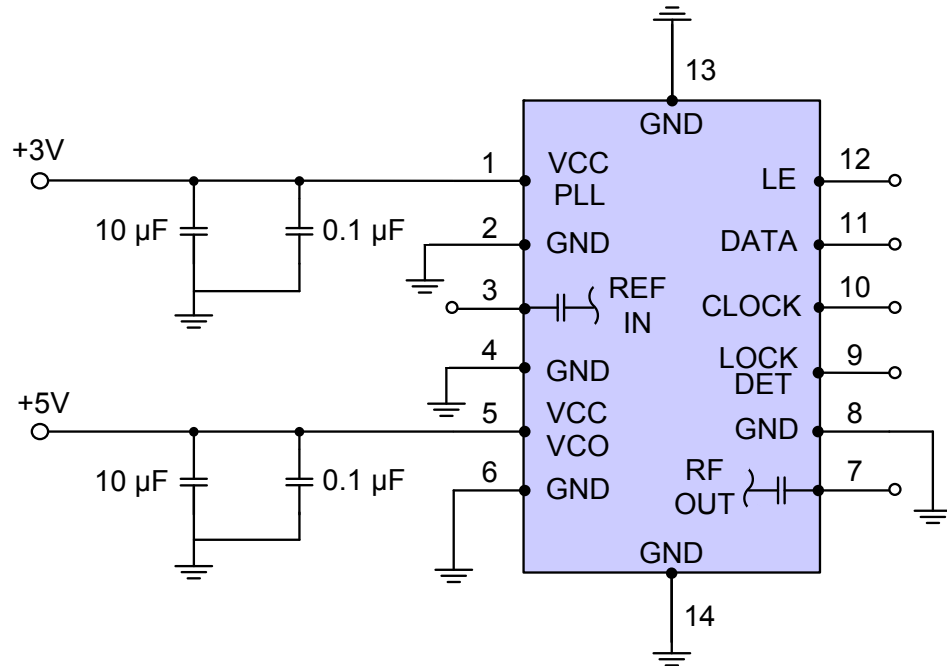

IF/RF MICROWAVE COMPONENTS • ISO 9001 ISO 14001 AS9100 CERTIFIED RoHS compliant  
 P.O. Box 350166, Brooklyn, New York 11235-0003 (718) 934-4500 Fax (718) 332-4661



The Design Engineers Search Engine finds the model you need, Instantly • For detailed performance specs & shopping online see



Notes: 1. Performance and quality attributes and conditions not expressly stated in this specification sheet are intended to be excluded and do not form a part of this specification sheet. 2. Electrical specifications and performance data contained herein are based on Mini-Circuit's applicable established test performance criteria and measurement instructions. 3. The parts covered by this specification sheet are subject to Mini-Circuits standard limited warranty and terms and conditions (collectively, "Standard Terms"); Purchasers of this part are entitled to the rights and benefits contained therein. For a full statement of the Standard Terms and the exclusive rights and remedies thereunder, please visit Mini-Circuits' website at [www.minicircuits.com/MCLStore/terms.jsp](http://www.minicircuits.com/MCLStore/terms.jsp).

## Device Marking

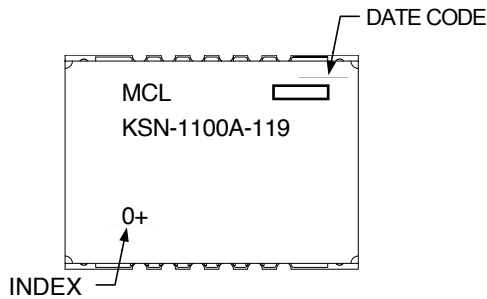

### Additional Detailed Technical Information

Additional information is available on our web site. To access this information enter the model number on our web site home page.

**Case Style:** DK1042

**Tape & Reel:** TR-F28

**Suggested Layout for PCB Design:** PL-249

**Evaluation Board:** TB-567-2+

**Environment Ratings:** ENV03T2



IF/RF MICROWAVE COMPONENTS • ISO 9001 ISO 14001 AS9100 CERTIFIED RoHS compliant  
P.O. Box 350166, Brooklyn, New York 11235-0003 (718) 934-4500 Fax (718) 332-4661



The Design Engineers Search Engine finds the model you need, Instantly • For detailed performance specs & shopping online see



Notes: 1. Performance and quality attributes and conditions not expressly stated in this specification sheet are intended to be excluded and do not form a part of this specification sheet. 2. Electrical specifications and performance data contained herein are based on Mini-Circuit's applicable established test performance criteria and measurement instructions. 3. The parts covered by this specification sheet are subject to Mini-Circuits standard limited warranty and terms and conditions (collectively, "Standard Terms"); Purchasers of this part are entitled to the rights and benefits contained therein. For a full statement of the Standard Terms and the exclusive rights and remedies thereunder, please visit Mini-Circuits' website at [www.minicircuits.com/MCLStore/terms.jsp](http://www.minicircuits.com/MCLStore/terms.jsp).