



CED4531/CEU4531

P-Channel Enhancement Mode Field Effect Transistor

FEATURES

- -30V, -25A, $R_{DS(ON)} = 36m\Omega$ @ $V_{GS} = -10V$.
 $R_{DS(ON)} = 57m\Omega$ @ $V_{GS} = -4.5V$.
- Super high dense cell design for extremely low $R_{DS(ON)}$.
- High power and current handling capability.
- Lead free product is acquired.
- TO-251 & TO-252 package.

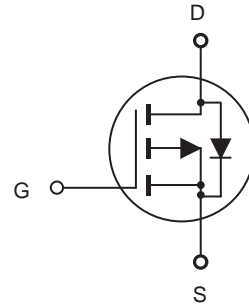

ABSOLUTE MAXIMUM RATINGS $T_C = 25^\circ C$ unless otherwise noted

| Parameter | Symbol | Limit | Units |
|---|----------------|------------|---------------|
| Drain-Source Voltage | V_{DS} | -30 | V |
| Gate-Source Voltage | V_{GS} | ± 20 | V |
| Drain Current-Continuous | I_D | -25 | A |
| Drain Current-Pulsed ^a | I_{DM} | -75 | A |
| Maximum Power Dissipation @ $T_C = 25^\circ C$ - Derate above $25^\circ C$ | P_D | 43 | W |
| | | 0.29 | W/ $^\circ C$ |
| Operating and Store Temperature Range | T_J, T_{stg} | -55 to 175 | $^\circ C$ |

Thermal Characteristics

| Parameter | Symbol | Limit | Units |
|---|-----------------|-------|--------------|
| Thermal Resistance, Junction-to-Case | $R_{\theta JC}$ | 3.5 | $^\circ C/W$ |
| Thermal Resistance, Junction-to-Ambient | $R_{\theta JA}$ | 50 | $^\circ C/W$ |



CED4531/CEU4531

Electrical Characteristics $T_A = 25^\circ\text{C}$ unless otherwise noted

| Parameter | Symbol | Test Condition | Min | Typ | Max | Units |
|---|--------------|---|-----|------|------|-----------|
| Off Characteristics | | | | | | |
| Drain-Source Breakdown Voltage | BV_{DSS} | $V_{GS} = 0V, I_D = -250\mu A$ | -30 | | | V |
| Zero Gate Voltage Drain Current | I_{DSS} | $V_{DS} = -24V, V_{GS} = 0V$ | | | -1 | μA |
| Gate Body Leakage Current, Forward | I_{GSSF} | $V_{GS} = 20V, V_{DS} = 0V$ | | | 100 | nA |
| Gate Body Leakage Current, Reverse | I_{GSSR} | $V_{GS} = -20V, V_{DS} = 0V$ | | | -100 | nA |
| On Characteristics ^c | | | | | | |
| Gate Threshold Voltage | $V_{GS(th)}$ | $V_{GS} = V_{DS}, I_D = -250\mu A$ | -1 | | -3 | V |
| Static Drain-Source On-Resistance | $R_{DS(on)}$ | $V_{GS} = -10V, I_D = -5.3A$ | | 30 | 36 | $m\Omega$ |
| | | $V_{GS} = -4.5V, I_D = -2.0A$ | | 47 | 57 | $m\Omega$ |
| Forward Transconductance | g_{FS} | $V_{DS} = -15V, I_D = -5.3A$ | | 8 | | S |
| Dynamic Characteristics ^d | | | | | | |
| Input Capacitance | C_{iss} | $V_{DS} = -15V, V_{GS} = 0V,$ $f = 1.0 \text{ MHz}$ | | 1300 | | pF |
| Output Capacitance | C_{oss} | | | 300 | | pF |
| Reverse Transfer Capacitance | C_{rss} | | | 150 | | pF |
| Switching Characteristics ^d | | | | | | |
| Turn-On Delay Time | $t_{d(on)}$ | $V_{DD} = -15V, I_D = -1A,$ $V_{GS} = -10V, R_{GEN} = 6\Omega$ | | 10 | 20 | ns |
| Turn-On Rise Time | t_r | | | 4 | 10 | ns |
| Turn-Off Delay Time | $t_{d(off)}$ | | | 58 | 80 | ns |
| Turn-On Fall Time | t_f | | | 23 | 30 | ns |
| Total Gate Charge | Q_g | $V_{DS} = -15V, I_D = -5.3A,$ $V_{GS} = -10V$ | | 20 | 25 | nC |
| Gate-Source Charge | Q_{gs} | | | 3 | | nC |
| Gate-Drain Charge | Q_{gd} | | | 5 | | nC |
| Drain-Source Diode Characteristics and Maximum Ratings | | | | | | |
| Drain-Source Diode Forward Current ^b | I_S | | | | -2.3 | A |
| Drain-Source Diode Forward Voltage ^c | V_{SD} | $V_{GS} = 0V, I_S = -2.3A$ | | | -1.2 | V |
| Notes : a.Repetitive Rating : Pulse width limited by maximum junction temperature. b.Surface Mounted on FR4 Board, $t \leq 10 \text{ sec}$. c.Pulse Test : Pulse Width $\leq 300\mu s$, Duty Cycle $\leq 2\%$. d.Guaranteed by design, not subject to production testing. | | | | | | |



CED4531/CEU4531

5

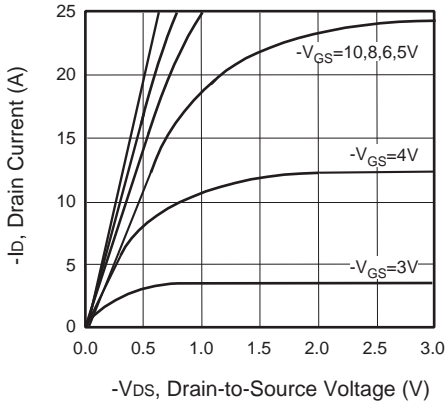

Figure 1. Output Characteristics

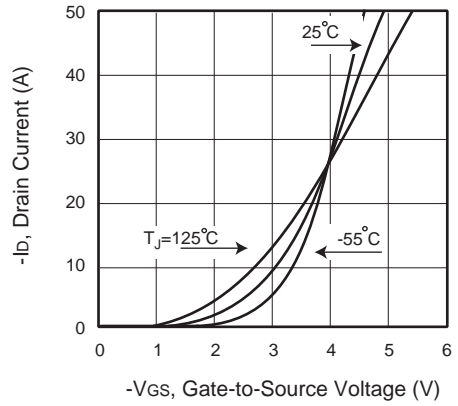

Figure 2. Transfer Characteristics

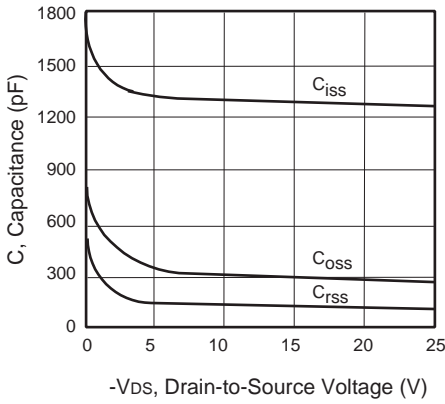

Figure 3. Capacitance

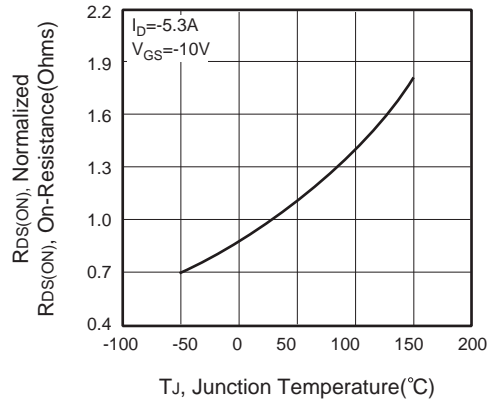

Figure 4. On-Resistance Variation with Temperature

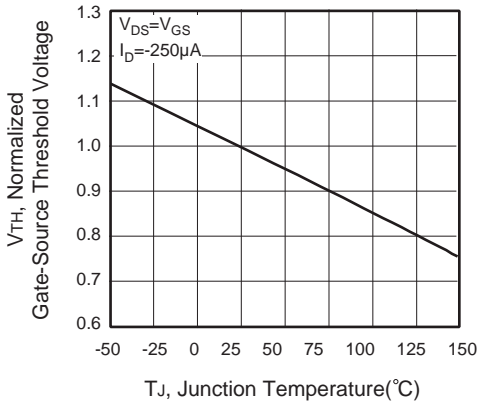

Figure 5. Gate Threshold Variation with Temperature

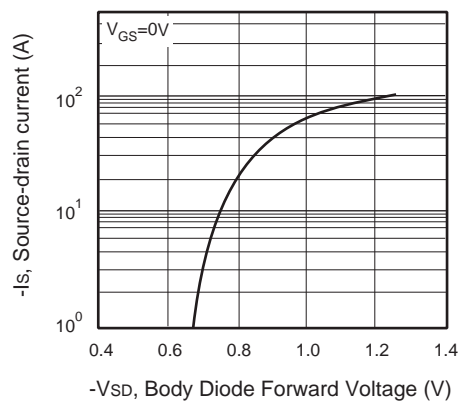

Figure 6. Body Diode Forward Voltage Variation with Source Current



CED4531/CEU4531

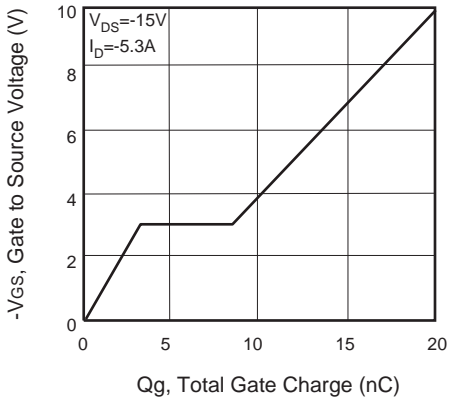

Figure 7. Gate Charge

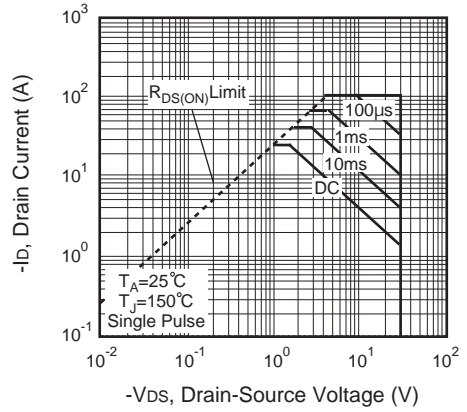

Figure 8. Maximum Safe Operating Area

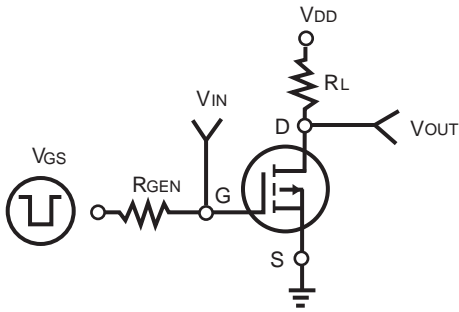

Figure 9. Switching Test Circuit

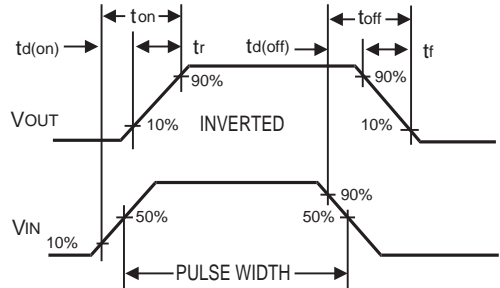

Figure 10. Switching Waveforms

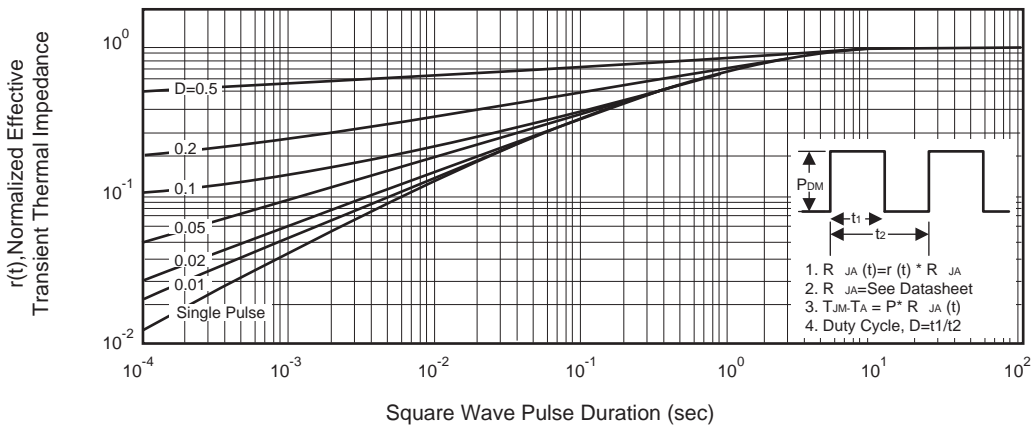

Figure 11. Normalized Thermal Transient Impedance Curve