

Micropower Voltage Supervisors

Features

- Ultra low supply current: 1.75 μ A (steady state max.)
- Precision monitoring options of:
 - 1.90V, 2.32V, 2.63V, 2.93V, 3.08V, 4.38V and 4.63V
- Resets microcontroller in a power-loss event
- $\overline{\text{RST}}$ pin (Active-low):
 - **MCP121**: Active-low, open-drain
 - **MCP131**: Active-low, open-drain with internal pull-up resistor
 - **MCP102** and **MCP103**: Active-low, push-pull
- Reset Delay Timer (120 ms delay typical)
- Available in SOT23-3, TO-92 and SC70 packages
- Temperature Range:
 - Extended: -40°C to $+125^{\circ}\text{C}$ (except **MCP1XX-195**)
 - Industrial: -40°C to $+85^{\circ}\text{C}$ (**MCP1XX-195** only)
- Lead Free Packaging

Applications

- Critical Microcontroller and Microprocessor Power Monitoring Applications
- Computers
- Intelligent Instruments
- Portable Battery-Powered Equipment

General Description

The MCP102/103/121/131 are voltage supervisor devices designed to keep a microcontroller in reset until the system voltage has reached and stabilized at the proper level for reliable system operation. The table below shows the available features for these devices.

TABLE 1: DEVICE FEATURES

Device	Output		Reset Delay (typ)	Package Pin Out (Pin # 1, 2, 3)	Comment
	Type	Pull-up Resistor			
MCP102	Push-Pull	No	120 ms	$\overline{\text{RST}}$, V_{DD} , V_{SS}	
MCP103	Push-Pull	No	120 ms	V_{SS} , $\overline{\text{RST}}$, V_{DD}	
MCP121	Open-Drain	External	120 ms	$\overline{\text{RST}}$, V_{DD} , V_{SS}	
MCP131	Open-Drain	Internal ($\sim 95 \text{ k}\Omega$)	120 ms	$\overline{\text{RST}}$, V_{DD} , V_{SS}	
MCP111	Open-Drain	External	No	V_{OUT} , V_{SS} , V_{DD}	See MCP111/112 Data Sheet (DS21889)
MCP112	Push-Pull	No	No	V_{OUT} , V_{SS} , V_{DD}	See MCP111/112 Data Sheet (DS21889)

Package Types

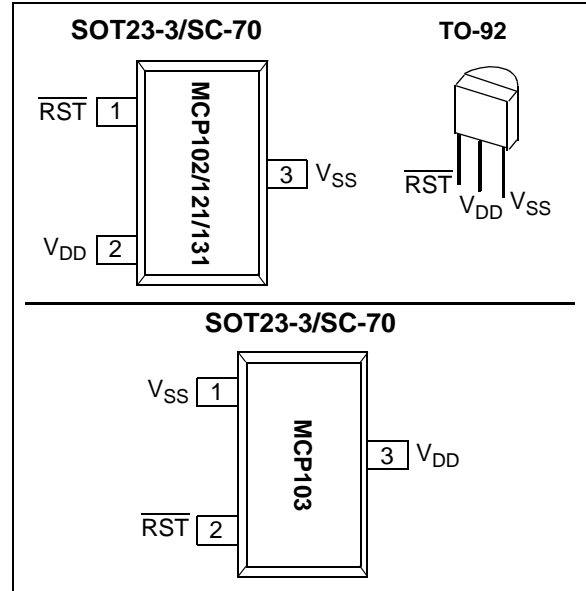

Block Diagram

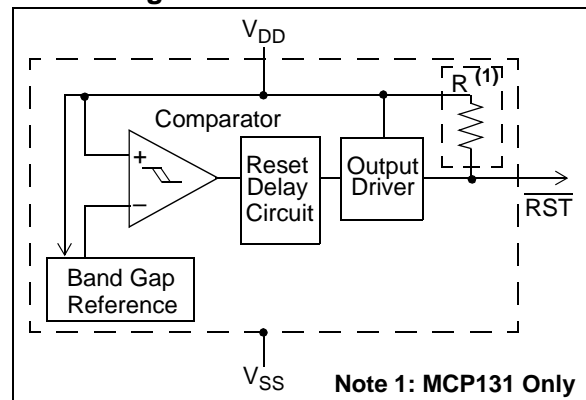

MCP102/103/121/131

1.0 ELECTRICAL CHARACTERISTICS

Absolute Maximum Ratings†

V_{DD}	7.0V
Input current (V_{DD})	10 mA
Output current (\overline{RST})	10 mA
Rated Rise Time of V_{DD}	100V/ μ s
All inputs and outputs w.r.t. V_{SS}	-0.6V to ($V_{DD} + 1.0V$)
Storage temperature	-65°C to +150°C
Ambient temp. with power applied	-40°C to +125°C
Maximum Junction temp. with power applied	150°C
ESD protection on all pins	≥ 2 kV

† **Notice:** Stresses above those listed under “Maximum Ratings” may cause permanent damage to the device. This is a stress rating only and functional operation of the device at those or any other conditions above those indicated in the operational listings of this specification is not implied. Exposure to maximum rating conditions for extended periods may affect device reliability.

DC CHARACTERISTICS

Electrical Specifications: Unless otherwise indicated, all limits are specified for: $V_{DD} = 1V$ to 5.5V, $R_{PU} = 100$ k Ω (MCP121 only), $T_A = -40^\circ C$ to $+125^\circ C$.							
Parameters	Sym	Min	Typ	Max	Units	Conditions	
Operating Voltage Range	V_{DD}	1.0	—	5.5	V		
Specified V_{DD} Value to \overline{RST} low	V_{DD}	1.0	—		V	$I_{\overline{RST}} = 10$ uA, $V_{\overline{RST}} < 0.2V$	
Operating Current	MCP102, MCP103, MCP121	I_{DD}	—	< 1	1.75	μ A	Reset Power-up Timer (t_{RPU}) Inactive
			—	—	20.0	μ A	Reset Power-up Timer (t_{RPU}) Active
	MCP131	I_{DD}	—	< 1	1.75	μ A	$V_{DD} > V_{TRIP}$ and Reset Power-up Timer (t_{RPU}) Inactive
			—	—	75	μ A	$V_{DD} < V_{TRIP}$ and Reset Power-up Timer (t_{RPU}) Inactive (Note 3)
			—	—	90	μ A	Reset Power-up Timer (t_{RPU}) Active (Note 4)
			—	—	—	—	—
V_{DD} Trip Point	MCP1XX-195	V_{TRIP}	1.872	1.900	1.929	V	$T_A = +25^\circ C$ (Note 1)
			1.853	1.900	1.948	V	$T_A = -40^\circ C$ to $+85^\circ C$ (Note 2)
	MCP1XX-240		2.285	2.320	2.355	V	$T_A = +25^\circ C$ (Note 1)
			2.262	2.320	2.378	V	(Note 2)
	MCP1XX-270		2.591	2.630	2.670	V	$T_A = +25^\circ C$ (Note 1)
			2.564	2.630	2.696	V	(Note 2)
	MCP1XX-300		2.886	2.930	2.974	V	$T_A = +25^\circ C$ (Note 1)
			2.857	2.930	3.003	V	(Note 2)
	MCP1XX-315		3.034	3.080	3.126	V	$T_A = +25^\circ C$ (Note 1)
			3.003	3.080	3.157	V	(Note 2)
	MCP1XX-450		4.314	4.380	4.446	V	$T_A = +25^\circ C$ (Note 1)
			4.271	4.380	4.490	V	(Note 2)
	MCP1XX-475		4.561	4.630	4.700	V	$T_A = +25^\circ C$ (Note 1)
			4.514	4.630	4.746	V	(Note 2)
V_{DD} Trip Point Tempco	T_{TPCO}	—	± 100	—	ppm/ $^\circ C$		

- Note 1:** Trip point is $\pm 1.5\%$ from typical value.
Note 2: Trip point is $\pm 2.5\%$ from typical value.
Note 3: \overline{RST} output is forced low. There is a current through the internal pull-up resistor.
Note 4: This includes the current through the internal pull-up resistor and the reset power-up timer.

DC CHARACTERISTICS (CONTINUED)

Electrical Specifications: Unless otherwise indicated, all limits are specified for:
 $V_{DD} = 1V$ to $5.5V$, $R_{PU} = 100\text{ k}\Omega$ (MCP121 only), $T_A = -40^\circ\text{C}$ to $+125^\circ\text{C}$.

Parameters		Sym	Min	Typ	Max	Units	Conditions
Threshold Hysteresis (min. = 1%, max = 6%)	MCP1XX-195	V_{HYS}	0.019	—	0.114	V	$T_A = +25^\circ\text{C}$
	MCP1XX-240		0.023	—	0.139	V	
	MCP1XX-270		0.026	—	0.158	V	
	MCP1XX-300		0.029	—	0.176	V	
	MCP1XX-315		0.031	—	0.185	V	
	MCP1XX-450		0.044	—	0.263	V	
	MCP1XX-475		0.046	—	0.278	V	
$\overline{\text{RST}}$ Low-level Output Voltage		V_{OL}	—	—	0.4	V	$I_{OL} = 500\text{ }\mu\text{A}$, $V_{DD} = V_{TRIP(MIN)}$
$\overline{\text{RST}}$ High-level Output Voltage (MCP102 and MCP103 only)		V_{OH}	$V_{DD} - 0.6$	—	—	V	$I_{OH} = 1\text{ mA}$, For MCP102/MCP103 only (push-pull output)
Internal Pull-up Resistor (MCP131 only)		R_{PU}	—	95	—	$\text{k}\Omega$	$V_{DD} = 5.5V$
Open-Drain Output Leakage Current (MCP121 only)		I_{OD}	—	0.1	—	μA	

- Note**
- 1: Trip point is $\pm 1.5\%$ from typical value.
 - 2: Trip point is $\pm 2.5\%$ from typical value.
 - 3: $\overline{\text{RST}}$ output is forced low. There is a current through the internal pull-up resistor.
 - 4: This includes the current through the internal pull-up resistor and the reset power-up timer.

MCP102/103/121/131

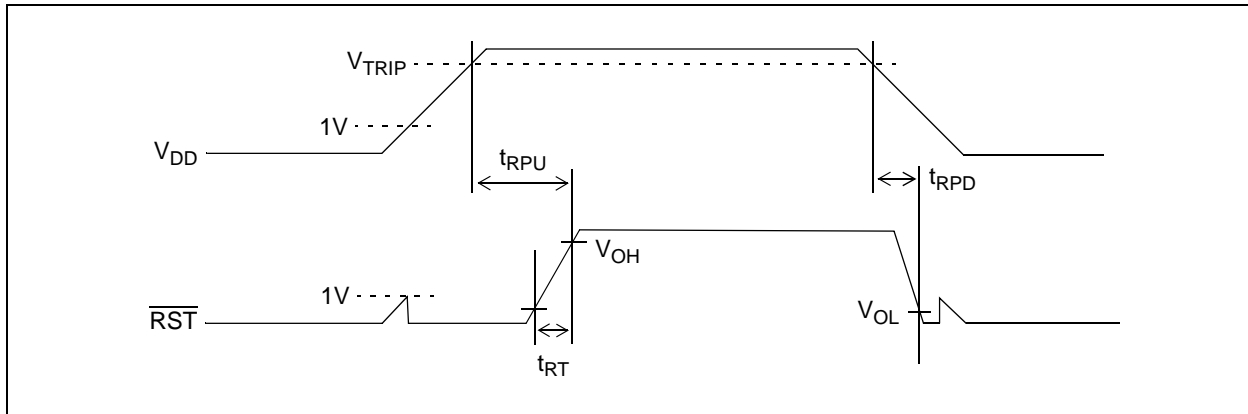

FIGURE 1-1: Timing Diagram.

AC CHARACTERISTICS

Electrical Specifications: Unless otherwise indicated, all limits are specified for:
 $V_{DD} = 1V$ to $5.5V$, $R_{PU} = 100\text{ k}\Omega$ (MCP121 only), $T_A = -40^\circ\text{C}$ to $+125^\circ\text{C}$.

Parameters	Sym	Min	Typ	Max	Units	Conditions
V_{DD} Detect to \overline{RST} Inactive	t_{RPU}	80	120	180	ms	Figure 1-1 and $C_L = 50\text{ pF}$
V_{DD} Detect to \overline{RST} Active	t_{RPD}	—	130	—	μs	V_{DD} ramped from $V_{TRIP(MAX)} + 250\text{ mV}$ down to $V_{TRIP(MIN)} - 250\text{ mV}$, per Figure 1-1, $C_L = 50\text{ pF}$ (Note 1)
\overline{RST} Rise Time After \overline{RST} Active (MCP102 and MCP103 only)	t_{RT}	—	5	—	μs	For \overline{RST} 10% to 90% of final value per Figure 1-1, $C_L = 50\text{ pF}$ (Note 1)

Note 1: These parameters are for design guidance only and are not 100% tested.

TEMPERATURE CHARACTERISTICS

Electrical Specifications: Unless otherwise noted, all limits are specified for:
 $V_{DD} = 1V$ to $5.5V$, $R_{PU} = 100\text{ k}\Omega$ (MCP121 only), $T_A = -40^\circ\text{C}$ to $+125^\circ\text{C}$.

Parameters	Sym	Min	Typ	Max	Units	Conditions
Temperature Ranges						
Specified Temperature Range	T_A	-40	—	+85	$^\circ\text{C}$	MCP1XX-195
Specified Temperature Range	T_A	-40	—	+125	$^\circ\text{C}$	Except MCP1XX-195
Maximum Junction Temperature	T_J	—	—	+150	$^\circ\text{C}$	
Storage Temperature Range	T_A	-65	—	+150	$^\circ\text{C}$	
Package Thermal Resistances						
Thermal Resistance, 3L-SOT23	θ_{JA}	—	336	—	$^\circ\text{C}/\text{W}$	
Thermal Resistance, 3L-SC-70	θ_{JA}	—	340	—	$^\circ\text{C}/\text{W}$	
Thermal Resistance, 3L-TO92	θ_{JA}	—	131.9	—	$^\circ\text{C}/\text{W}$	

2.0 TYPICAL PERFORMANCE CURVES

Note: The graphs and tables provided following this note are a statistical summary based on a limited number of samples and are provided for informational purposes only. The performance characteristics listed herein are not tested or guaranteed. In some graphs or tables, the data presented may be outside the specified operating range (e.g., outside specified power supply range) and therefore outside the warranted range.

Note: Unless otherwise indicated, all limits are specified for:

$V_{DD} = 1V$ to $5.5V$, $R_{PU} = 100\text{ k}\Omega$ (MCP121 only; see Figure 4-1), $T_A = -40^\circ\text{C}$ to $+125^\circ\text{C}$.

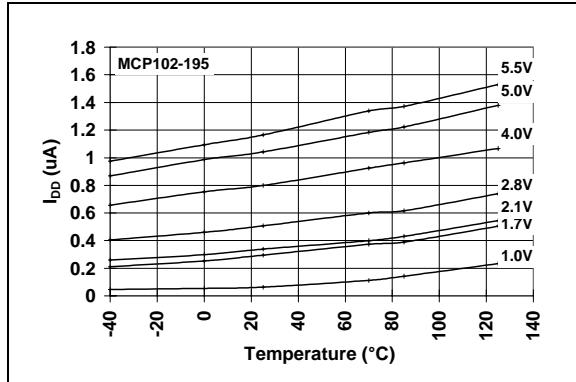

FIGURE 2-1: I_{DD} vs. Temperature (Reset Power-up Timer Inactive) (MCP102-195).

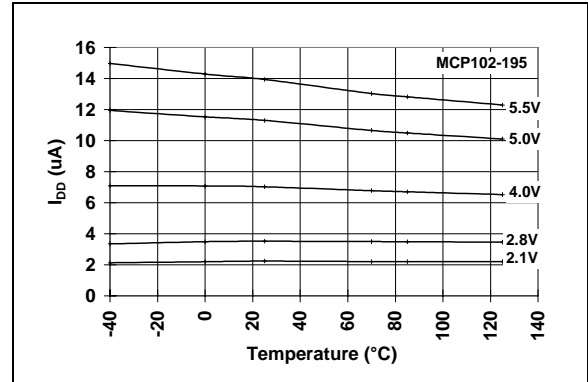

FIGURE 2-4: I_{DD} vs. Temperature (Reset Power-up Timer Active) (MCP102-195).

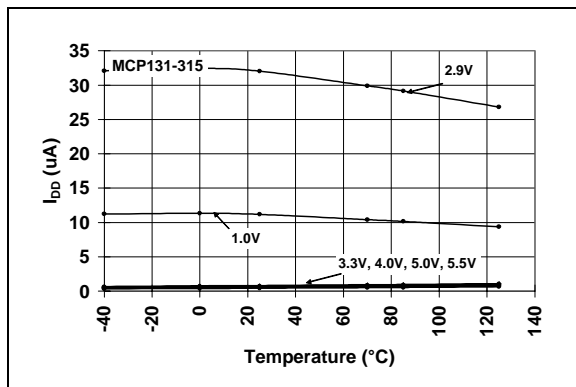

FIGURE 2-2: I_{DD} vs. Temperature (Reset Power-up Timer Inactive) (MCP131-315).

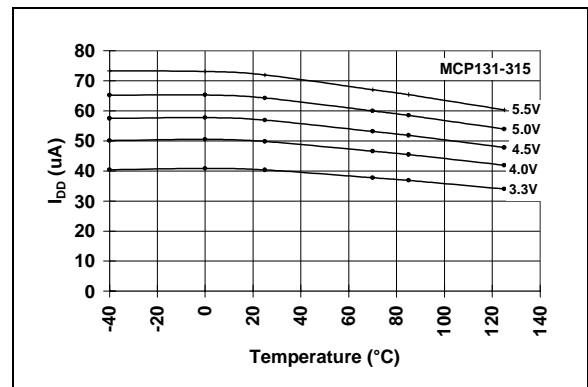

FIGURE 2-5: I_{DD} vs. Temperature (Reset Power-up Timer Active) (MCP131-315).

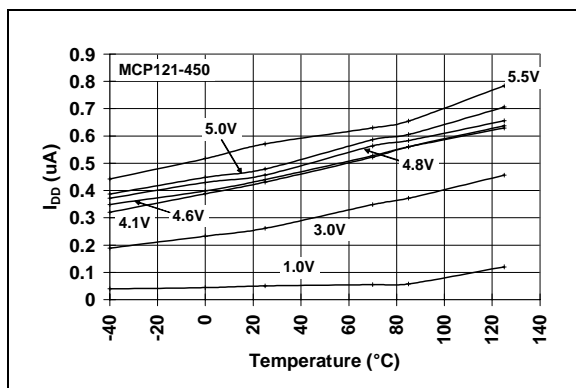

FIGURE 2-3: I_{DD} vs. Temperature (Reset Power-up Timer Inactive) (MCP121-450).

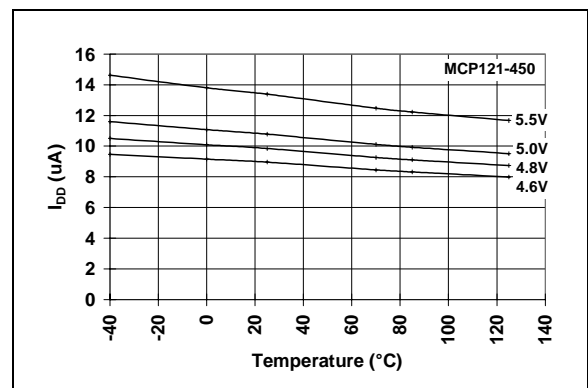

FIGURE 2-6: I_{DD} vs. Temperature (Reset Power-up Timer Active) (MCP121-450).

MCP102/103/121/131

Note: Unless otherwise indicated, all limits are specified for:

$V_{DD} = 1V$ to $5.5V$, $R_{PU} = 100\text{ k}\Omega$ (MCP121 only; see Figure 4-1), $T_A = -40^\circ\text{C}$ to $+125^\circ\text{C}$.

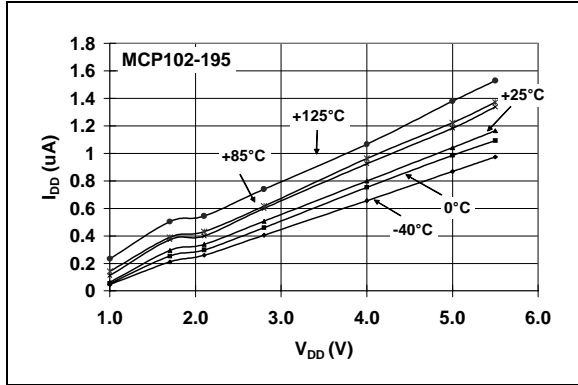

FIGURE 2-7: I_{DD} vs. V_{DD} (Reset Power-up Timer Inactive) (MCP102-195).

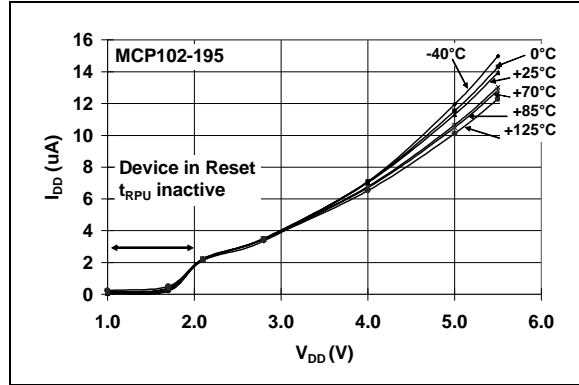

FIGURE 2-10: I_{DD} vs. V_{DD} (Reset Power-up Timer Active) (MCP102-195).

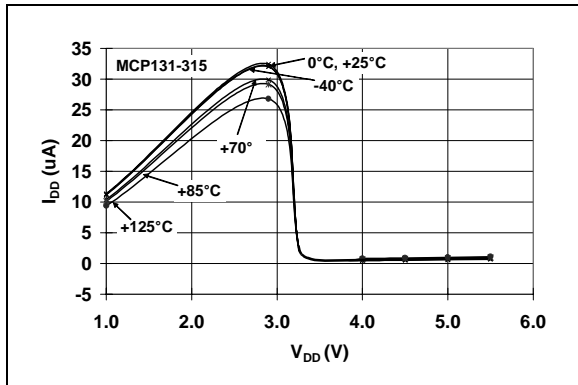

FIGURE 2-8: I_{DD} vs. V_{DD} (Reset Power-up Timer Inactive) (MCP131-315).

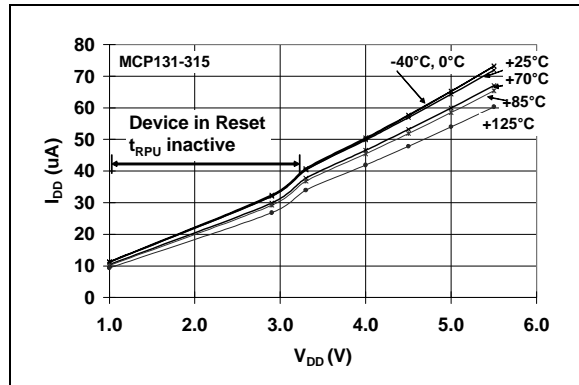

FIGURE 2-11: I_{DD} vs. V_{DD} (Reset Power-up Timer Active) (MCP131-315).

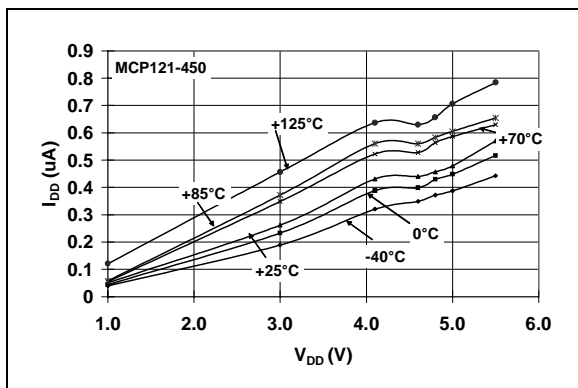

FIGURE 2-9: I_{DD} vs. V_{DD} (Reset Power-up Timer Inactive) (MCP121-450).

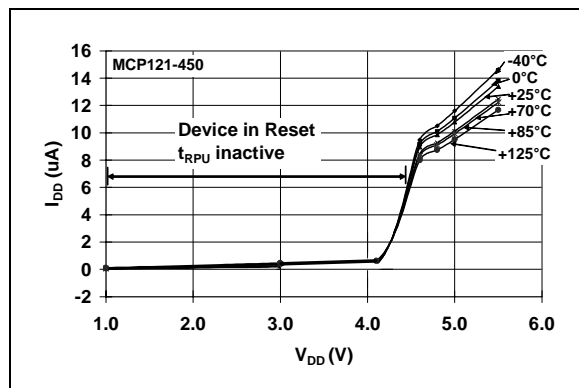

FIGURE 2-12: I_{DD} vs. V_{DD} (Reset Power-up Timer Active) (MCP121-450).

MCP102/103/121/131

Note: Unless otherwise indicated, all limits are specified for:
 $V_{DD} = 1V$ to $5.5V$, $R_{PU} = 100\text{ k}\Omega$ (MCP121; see Figure 4-1), $T_A = -40^\circ\text{C}$ to $+125^\circ\text{C}$.

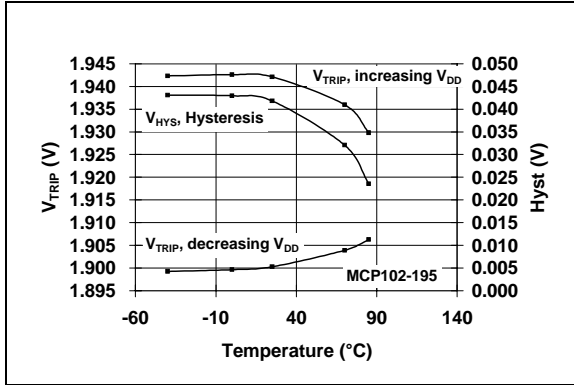

FIGURE 2-13: V_{TRIP} vs. Temperature vs. Hysteresis (MCP102-195).

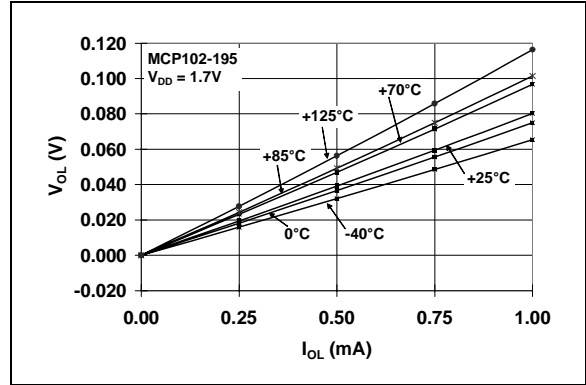

FIGURE 2-16: V_{OL} vs. I_{OL} (MCP102-195 @ $V_{DD} = 1.7V$).

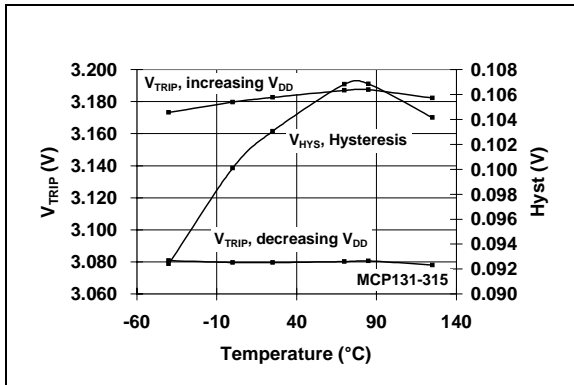

FIGURE 2-14: V_{TRIP} vs. Temperature vs. Hysteresis (MCP131-315).

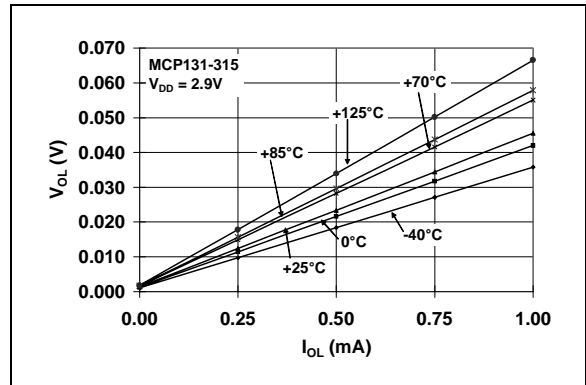

FIGURE 2-17: V_{OL} vs. I_{OL} (MCP131-315 @ $V_{DD} = 2.9V$).

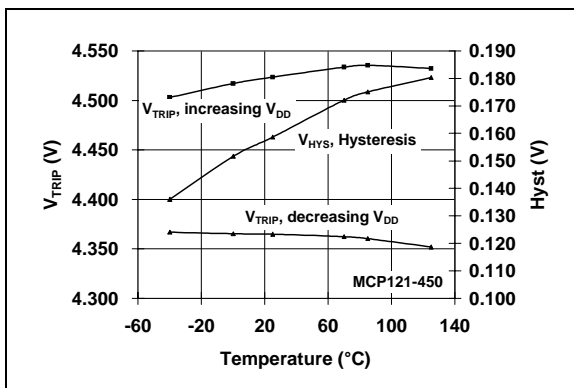

FIGURE 2-15: V_{TRIP} vs. Temperature vs. Hysteresis (MCP121-450).

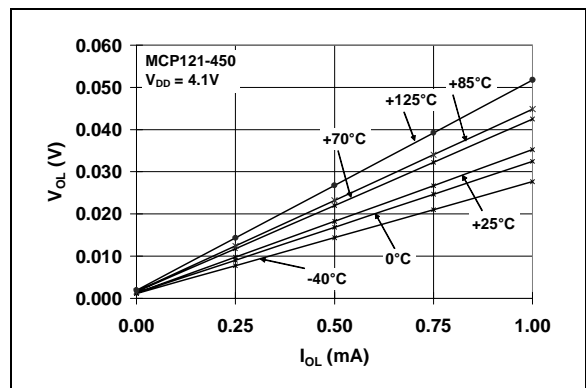

FIGURE 2-18: V_{OL} vs. I_{OL} (MCP121-450 @ $V_{DD} = 4.1V$).

MCP102/103/121/131

Note: Unless otherwise indicated, all limits are specified for:

$V_{DD} = 1V$ to $5.5V$, $R_{PU} = 100\text{ k}\Omega$ (MCP121 only; see Figure 4-1), $T_A = -40^\circ\text{C}$ to $+125^\circ\text{C}$.

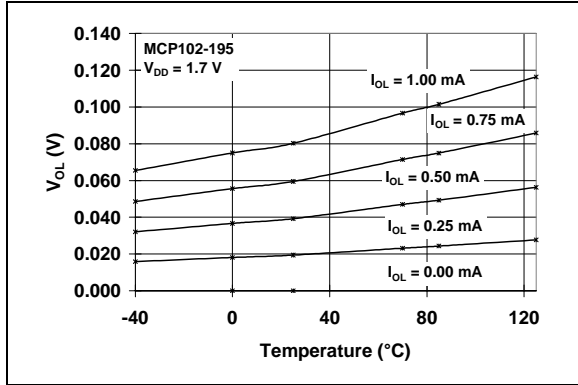

FIGURE 2-19: V_{OL} vs. Temperature (MCP102-195 @ $V_{DD} = 1.7V$).

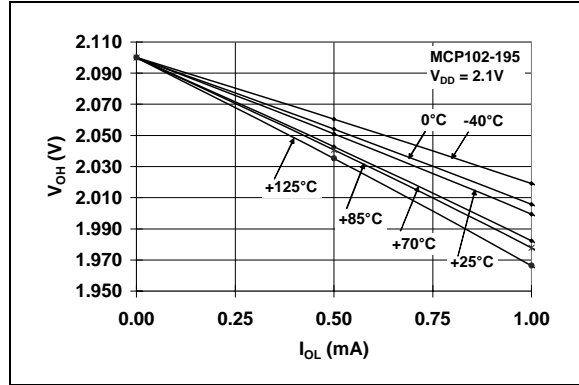

FIGURE 2-22: V_{OH} vs. I_{OL} (MCP102-195 @ $V_{DD} = 2.1V$).

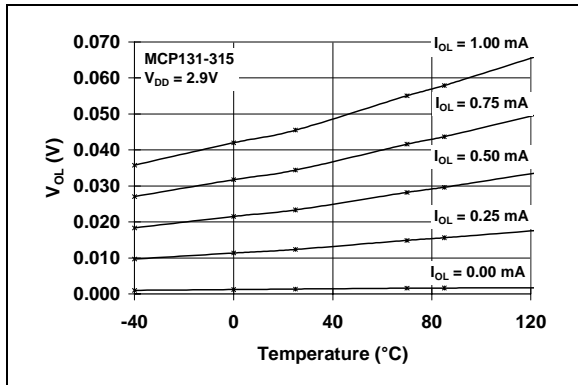

FIGURE 2-20: V_{OL} vs. Temperature (MCP131-315 @ $V_{DD} = 2.9V$).

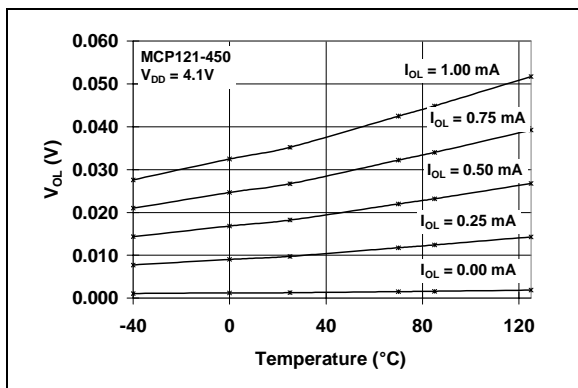

FIGURE 2-21: V_{OL} vs. Temperature (MCP121-450 @ $V_{DD} = 4.1V$).

MCP102/103/121/131

Note: Unless otherwise indicated, all limits are specified for:

$V_{DD} = 1V$ to $5.5V$, $R_{PU} = 100\text{ k}\Omega$ (MCP121 only; see Figure 4-1), $T_A = -40^\circ\text{C}$ to $+125^\circ\text{C}$.

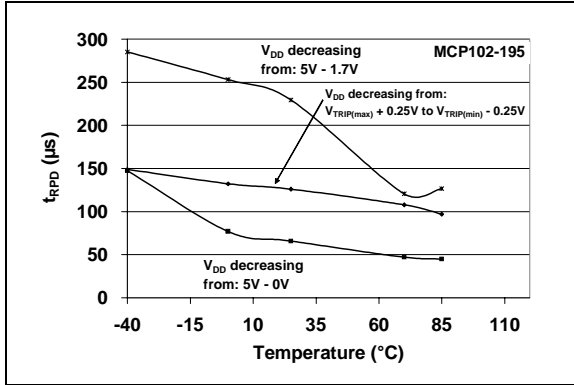

FIGURE 2-23: t_{RPD} vs. Temperature (MCP102-195).

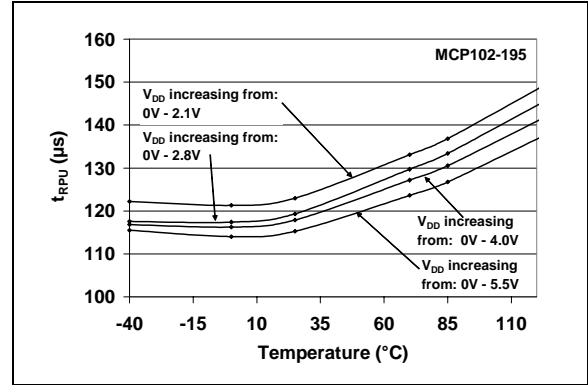

FIGURE 2-26: t_{RPU} vs. Temperature (MCP102-195).

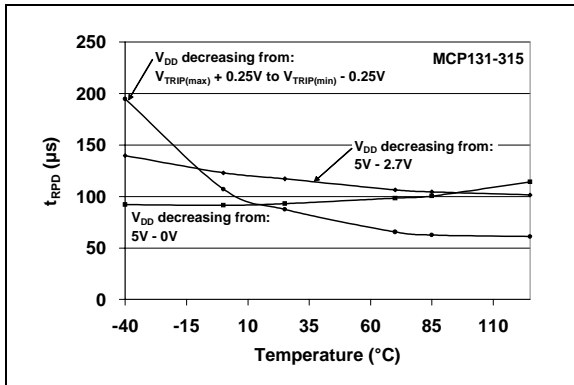

FIGURE 2-24: t_{RPD} vs. Temperature (MCP131-315).

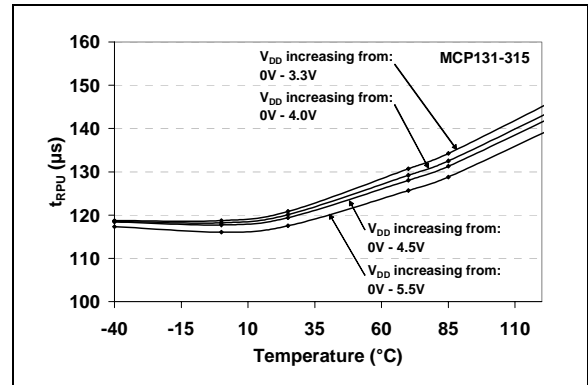

FIGURE 2-27: t_{RPU} vs. Temperature (MCP131-315).

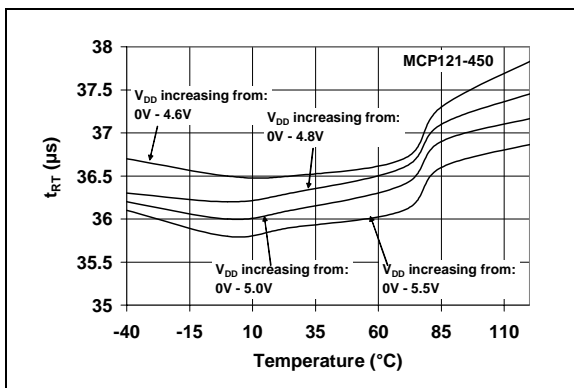

FIGURE 2-25: t_{RPD} vs. Temperature (MCP121-450).

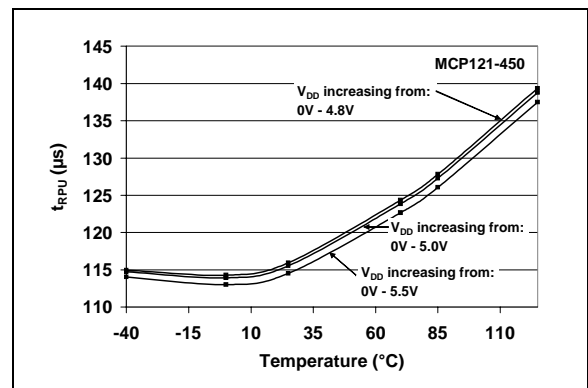

FIGURE 2-28: t_{RPU} vs. Temperature (MCP121-450).

MCP102/103/121/131

Note: Unless otherwise indicated, all limits are specified for:

$V_{DD} = 1V$ to $5.5V$, $R_{PU} = 100\text{ k}\Omega$ (MCP121 only; see Figure 4-1), $T_A = -40^\circ\text{C}$ to $+125^\circ\text{C}$.

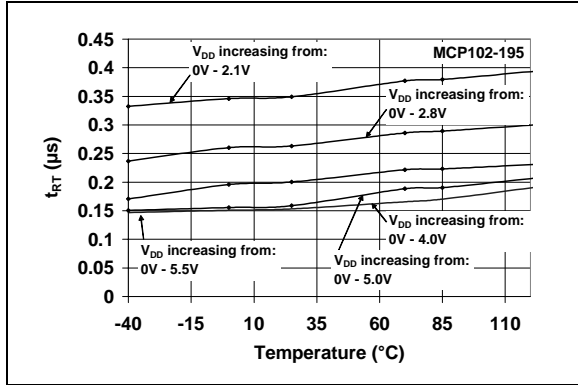

FIGURE 2-29: t_{RT} vs. Temperature (MCP102-195).

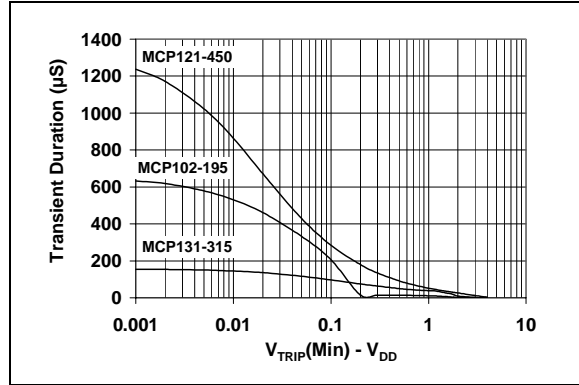

FIGURE 2-32: Transient Duration vs. $V_{TRIP}(\text{min}) - V_{DD}$.

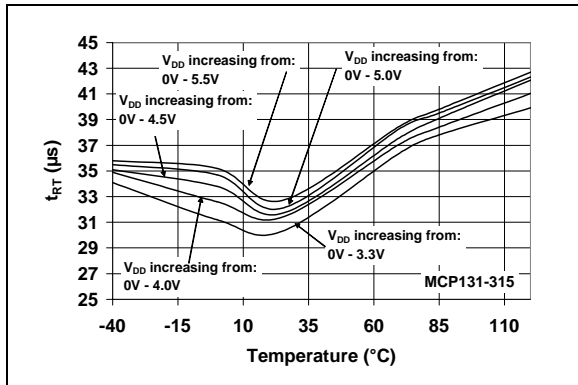

FIGURE 2-30: t_{RT} vs. Temperature (MCP131-315).

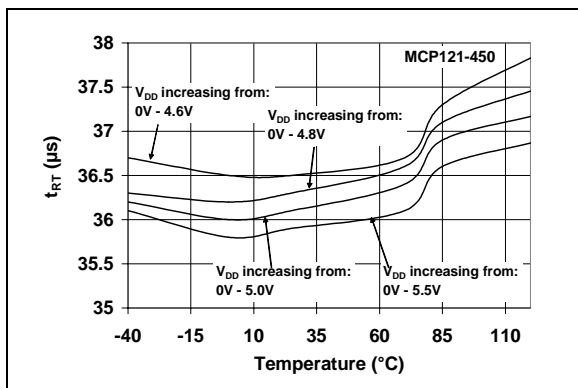

FIGURE 2-31: t_{RT} vs. Temperature (MCP121-450).

3.0 PIN DESCRIPTION

The descriptions of the pins are listed in Table 3-1.

TABLE 3-1: PIN FUNCTION TABLE

Pin No.		Symbol	Function
MCP102 MCP121 MCP131	MCP103		
1	1	$\overline{\text{RST}}$	Output State V_{DD} Falling: H = $V_{\text{DD}} > V_{\text{TRIP}}$ L = $V_{\text{DD}} < V_{\text{TRIP}}$ V_{DD} Rising: H = $V_{\text{DD}} > V_{\text{TRIP}} + V_{\text{HYS}}$ L = $V_{\text{DD}} < V_{\text{TRIP}} + V_{\text{HYS}}$
2	3	V _{DD}	Positive power supply
3	2	V _{SS}	Ground reference

MCP102/103/121/131

4.0 APPLICATION INFORMATION

For many of today's microcontroller applications, care must be taken to prevent low-power conditions that can cause many different system problems. The most common causes are brown-out conditions, where the system supply drops below the operating level momentarily. The second most common cause is when a slowly decaying power supply causes the microcontroller to begin executing instructions without sufficient voltage to sustain volatile memory (RAM), thus producing indeterminate results. Figure 4-1 shows a typical application circuit.

The MCP102/103/121/131 are voltage supervisor devices designed to keep a microcontroller in reset until the system voltage has reached and stabilized at the proper level for reliable system operation. These devices also operate as protection from brown-out conditions when the system supply voltage drops below a safe operating level.

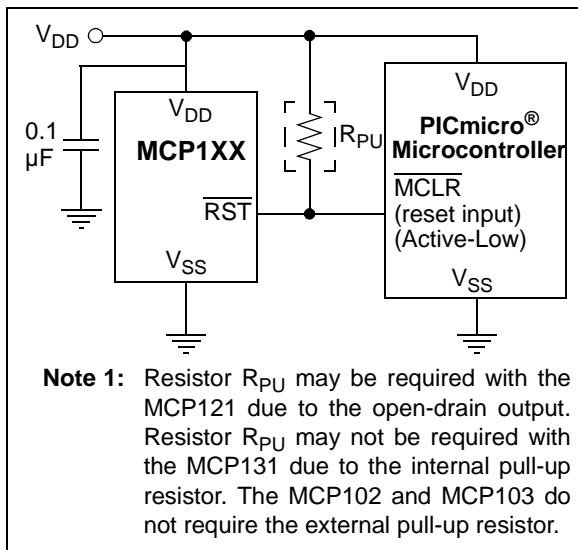

FIGURE 4-1: Typical Application Circuit.

4.1 \overline{RST} Operation

The \overline{RST} output pin operation determines how the device can be used, and indicates when the system should be forced into reset. To accomplish this, an internal voltage reference is used to set the voltage trip point (V_{TRIP}). Additionally, there is a hysteresis on this trip point.

When the falling edge of V_{DD} crosses this voltage threshold, the reset power-down timer (T_{RPD}) starts. When this delay timer times out (T_{RPD}), the \overline{RST} pin is forced low.

When the rising-edge of V_{DD} crosses this voltage threshold, the reset power-up timer (T_{RPU}) starts. When this delay timer times out (T_{RPU}), the \overline{RST} pin is forced high, the reset power-up timer is active and there is additional system current.

The actual voltage trip point (V_{TRIPAC}) will be between the minimum trip point ($V_{TRIPMIN}$) and the maximum trip point ($V_{TRIPMAX}$). The hysteresis on this trip point and the delay timer (T_{RPU}) are to remove any "jitter" that would occur on the \overline{RST} pin when the device V_{DD} is at the trip point.

Figure 4-2 shows the waveform of the \overline{RST} pin as determined by the V_{DD} voltage, while Table 4-1 shows the state of the \overline{RST} pin. The V_{TRIP} specification is for falling V_{DD} voltages. When the V_{DD} voltage is rising, the \overline{RST} will not be driven high until V_{DD} is at $V_{TRIP} + V_{HYS}$. Once V_{DD} has crossed the voltage trip point, there is also a minimal delay time (T_{RPD}) before the \overline{RST} pin is driven low.

TABLE 4-1: \overline{RST} PIN STATES

Device	State of \overline{RST} Pin when:		Output Driver
	$V_{DD} < V_{TRIP}$	$V_{DD} > V_{TRIP} + V_{HYS}$	
MCP102	L	H	Push-pull
MCP103	L	H	Push-pull
MCP121	L	H (1)	Open-drain (1)
MCP131	L	H (2)	Open-drain (2)

Note 1: Requires External Pull-up resistor

2: Has Internal Pull-up resistor

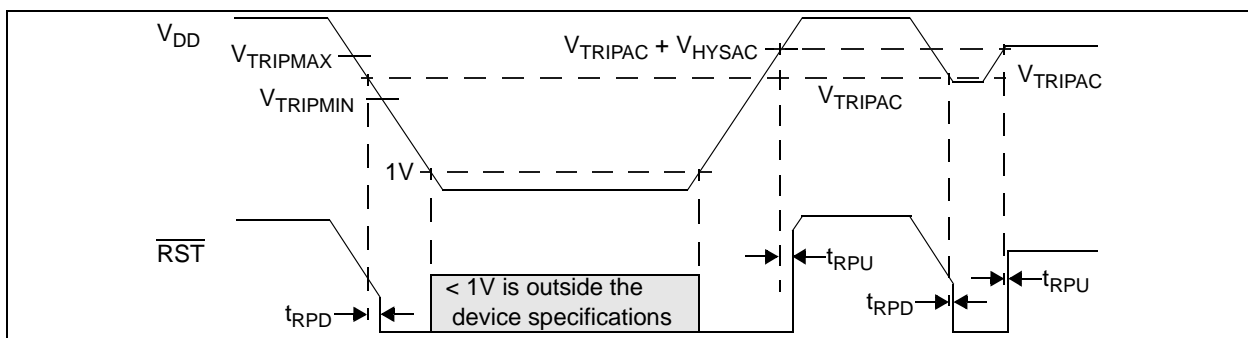

FIGURE 4-2: \overline{RST} Operation as Determined by the V_{TRIP} and V_{HYS} .

MCP102/103/121/131

5.0 PACKAGING INFORMATION

5.1 Package Marking Information

3-Lead TO-92

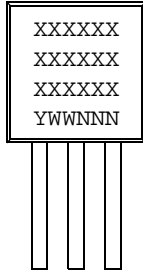

Example:

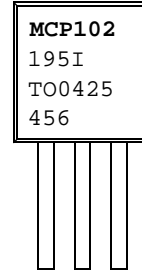

3-Pin SC-70

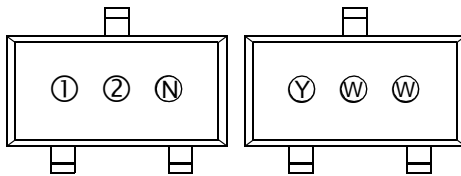

Top Side

Bottom Side

Example:

Part Number	MCP1xx =			
	MCP102	MCP103	MCP121	MCP131
MCP1xxT-195I/LB	BGN	FGN	DGN	CGN
MCP1xxT-240E/LB	BHN	FHN	DHN	CHN
MCP1xxT-270E/LB	BJN	FJN	DJN	CJN
MCP1xxT-300E/LB	BKN	FKN	DKN	CKN
MCP1xxT-315E/LB	BLN	FLN	DLN	CLN
MCP1xxT-450E/LB	BMN	FMN	DMN	CMN
MCP1xxT-475E/LB	BPN	FPN	DPN	CPN

3-Pin SOT-23

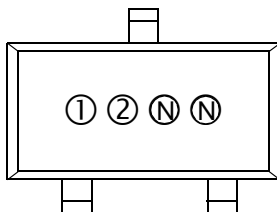

Example:

Part Number	MCP1xx =			
	MCP102	MCP103	MCP121	MCP131
MCP1xxT-195I/TT	JGNN	TGNN	LGNN	KGNN
MCP1xxT-240ETT	JHNN	THNN	LHNN	KHNN
MCP1xxT-270E/TT	JJNN	TJNN	LJNN	KJNN
MCP1xxT-300E/TT	JKNN	TKNN	LKNN	KKNN
MCP1xxT-315E/TT	JLNN	TLNN	LLNN	KLNN
MCP1xxT-450E/TT	JMNN	TMNN	LMNN	KMNN
MCP1xxT-475E/TT	JPNN	TPNN	LPNN	KPNN

Legend:	1	Part Number + temperature range and voltage (two-digit code)
	2	Part Number + temperature range and voltage (two-digit code)
	Y	Year (Y, YY)
	WW	Work Week
	N	Traceability Code (N, NN, NNN)

Note: In the event the full Microchip part number cannot be marked on one line, it will be carried over to the next line thus limiting the number of available characters for customer specific information.

MCP102/103/121/131

3-Lead Plastic Small Outline Transistor (TT) (SOT-23)

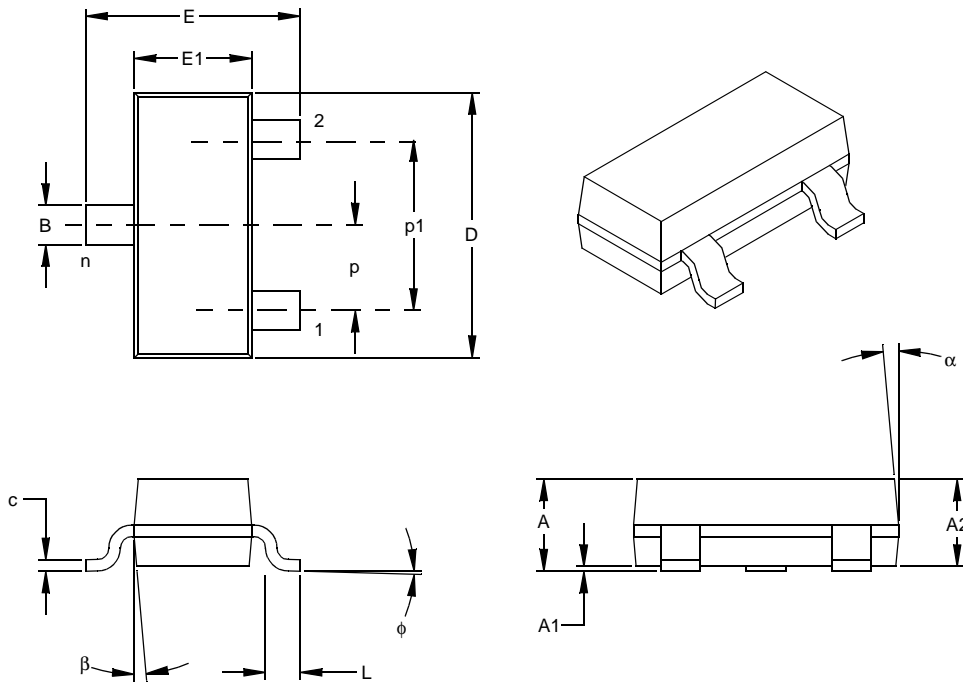

Dimension Limits	Units	INCHES*			MILLIMETERS		
		MIN	NOM	MAX	MIN	NOM	MAX
Number of Pins	n		3			3	
Pitch	p		.038			0.96	
Outside lead pitch (basic)	p1		.076			1.92	
Overall Height	A	.035	.040	.044	0.89	1.01	1.12
Molded Package Thickness	A2	.035	.037	.040	0.88	0.95	1.02
Standoff §	A1	.000	.002	.004	0.01	0.06	0.10
Overall Width	E	.083	.093	.104	2.10	2.37	2.64
Molded Package Width	E1	.047	.051	.055	1.20	1.30	1.40
Overall Length	D	.110	.115	.120	2.80	2.92	3.04
Foot Length	L	.014	.018	.022	0.35	0.45	0.55
Foot Angle	φ	0	5	10	0	5	10
Lead Thickness	c	.004	.006	.007	0.09	0.14	0.18
Lead Width	B	.015	.017	.020	0.37	0.44	0.51
Mold Draft Angle Top	α	0	5	10	0	5	10
Mold Draft Angle Bottom	β	0	5	10	0	5	10

* Controlling Parameter
 § Significant Characteristic

Notes:

Dimensions D and E1 do not include mold flash or protrusions. Mold flash or protrusions shall not exceed .010" (0.254mm) per side.

JEDEC Equivalent: TO-236
 Drawing No. C04-104

MCP102/103/121/131

3-Lead Plastic Small Outline Transistor (LB) (SC-70)

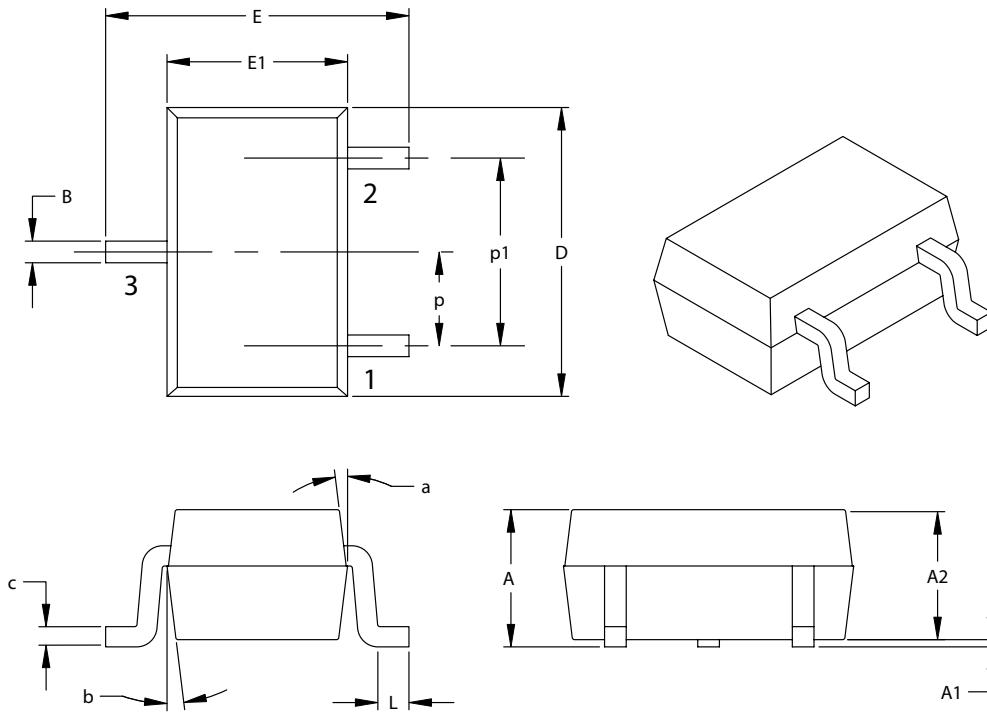

Dimension Limits	Units	INCHES		MILLIMETERS*	
		MIN	MAX	MIN	MAX
Number of Pins		3		3	
Pitch	P	.026 BSC.		0.65 BSC.	
Outside lead pitch (basic)	p1	.051 BSC.		1.30 BSC.	
Overall Height	A	.031	.043	0.80	1.10
Molded Package Thickness	A2	.031	.039	0.80	1.00
Standoff	A1	.000	.0004	0.00	.010
Overall Width	E	.071	.094	1.80	2.40
Molded Package Width	E1	.045	.053	1.15	1.35
Overall Length	D	.071	.089	1.80	2.25
Foot Length	L	.004	.016	0.10	0.41
Lead Thickness	c	.003	.010	0.08	0.25
Lead Width	B	.006	.016	0.15	0.40
Mold Draft Angle Top	a	8°	12°	8°	12°
Mold Draft Angle Bottom	b	8°	12°	8°	12°

*Controlling Parameter

Notes:

Dimensions D and E1 do not include mold flash or protrusions. Mold flash or protrusions shall not exceed .005" (0.127mm) per side.

JEITA (EIAJ) Equivalent: SC70

Drawing No. C04-104

MCP102/103/121/131

3-Lead Plastic Transistor Outline (TO) (TO-92)

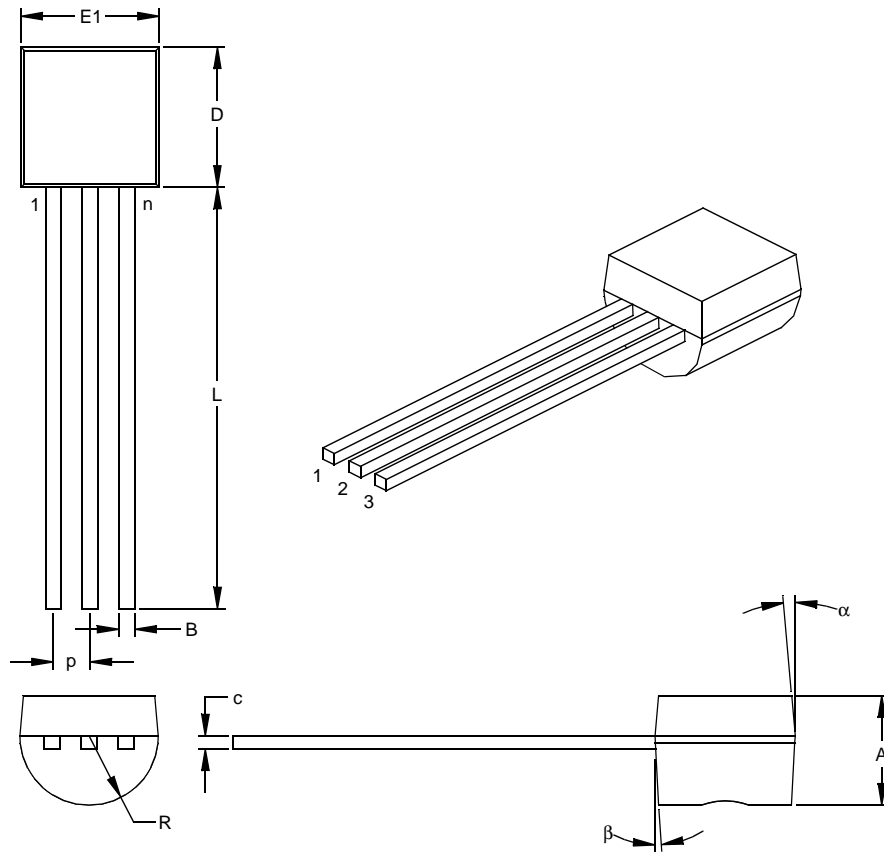

Dimension	Units	INCHES*			MILLIMETERS		
		MIN	NOM	MAX	MIN	NOM	MAX
Number of Pins	n		3			3	
Pitch	p		.050			1.27	
Bottom to Package Flat	A	.130	.143	.155	3.30	3.62	3.94
Overall Width	E1	.175	.186	.195	4.45	4.71	4.95
Overall Length	D	.170	.183	.195	4.32	4.64	4.95
Molded Package Radius	R	.085	.090	.095	2.16	2.29	2.41
Tip to Seating Plane	L	.500	.555	.610	12.70	14.10	15.49
Lead Thickness	c	.014	.017	.020	0.36	0.43	0.51
Lead Width	B	.016	.019	.022	0.41	0.48	0.56
Mold Draft Angle Top	α	4	5	6	4	5	6
Mold Draft Angle Bottom	β	2	3	4	2	3	4

*Controlling Parameter

Notes:

Dimensions D and E1 do not include mold flash or protrusions. Mold flash or protrusions shall not exceed .010" (0.254mm) per side.

JEDEC Equivalent: TO-92

Drawing No. C04-101

MCP102/103/121/131

5.2 Product Tape and Reel Specifications

FIGURE 5-1: EMBOSSED CARRIER DIMENSIONS (8, 12, 16 AND 24 MM TAPE ONLY)

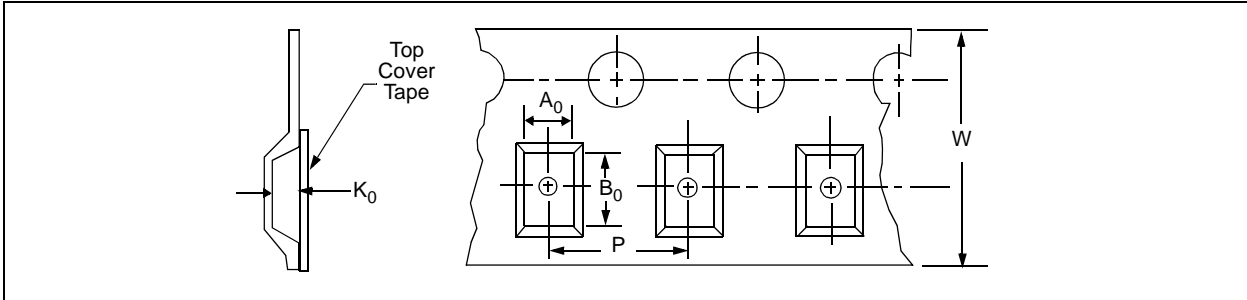

TABLE 1: CARRIER TAPE/CAVITY DIMENSIONS

Case Outline	Package Type		Carrier Dimensions		Cavity Dimensions			Output Quantity Units	Reel Diameter in mm
			W mm	P mm	A0 mm	B0 mm	K0 mm		
TT	SOT-23	3L	8	4	3.15	2.77	1.22	3000	180
LB	SC-70	3L	8	4	2.4	2.4	1.19	3000	180

FIGURE 5-2: 3-LEAD SOT-23/SC70 DEVICE TAPE AND REEL SPECIFICATIONS

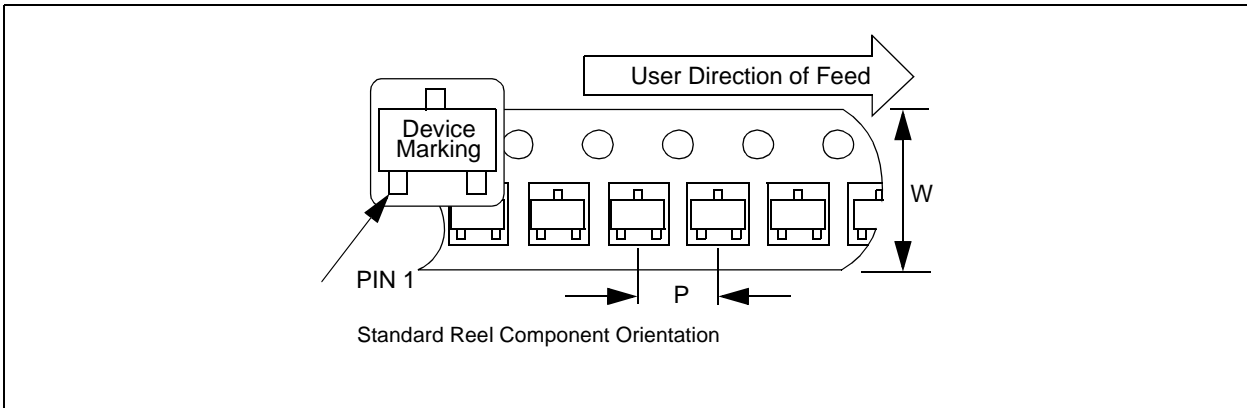
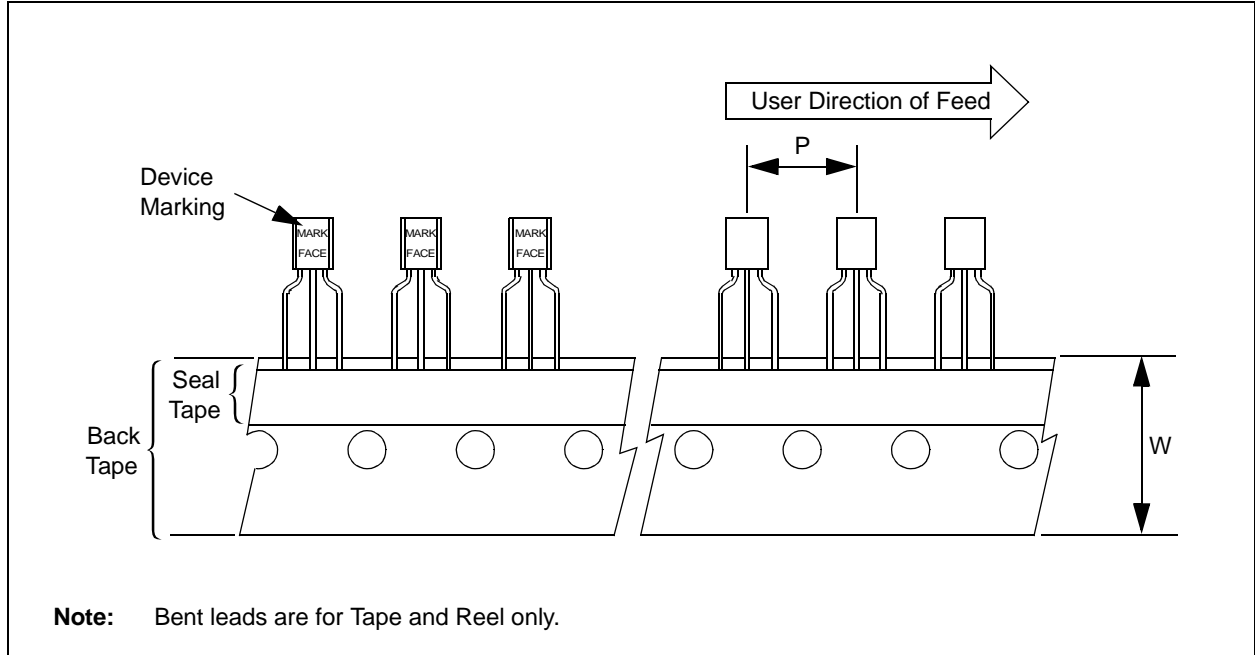

FIGURE 5-3: TO-92 DEVICE TAPE AND REEL SPECIFICATIONS



MCP102/103/121/131

NOTES:

PRODUCT IDENTIFICATION SYSTEM

To order or obtain information, e.g., on pricing or delivery, refer to the factory or the listed sales office.

<u>PART NO.</u>	- <u>X</u>	<u>XXX</u>	<u>X</u>	/	<u>XX</u>	Examples:
Device	Tape/Reel Option	Monitoring Options	Temperature Range		Package	
<p>Device:</p> <p>MCP102: MicroPower Voltage Supervisor, push-pull MCP102T: MicroPower Voltage Supervisor, push-pull (Tape and Reel)</p> <p>MCP103: MicroPower Voltage Supervisor, push-pull MCP103T: MicroPower Voltage Supervisor, push-pull (Tape and Reel)</p> <p>MCP121: MicroPower Voltage Supervisor, open-drain MCP121T: MicroPower Voltage Supervisor, open-drain (Tape and Reel)</p> <p>MCP131: MicroPower Voltage Supervisor, open-drain MCP131T: MicroPower Voltage Supervisor, open-drain (Tape and Reel)</p> <p>Monitoring Options:</p> <p>195 = 1.90V 240 = 2.32V 270 = 2.63V 300 = 2.93V 315 = 3.08V 450 = 4.38V 475 = 4.63V</p> <p>Temperature Range:</p> <p>I = -40°C to +85°C (MCP11X-195 only) E = -40°C to +125°C (Except MCP11X-195 only)</p> <p>Package:</p> <p>TT = SOT-23B, 3-lead LB = SC-70, 3-lead TO = TO-92, 3-lead</p> <p>Lead Finish: Blank = Matte Tin (Pure Sn)</p>						<p>a) MCP102T-195I/TT: Tape and Reel, 1.95V MicroPower Voltage Supervisor, push-pull, -40°C to +85°C, SOT-23B-3 package.</p> <p>b) MCP102-300E/TO: 3.00V MicroPower Voltage Supervisor, push-pull, -40°C to +125°C, TO-92-3 package.</p> <p>a) MCP103T-270E/TT: Tape and Reel, 2.70V MicroPower Voltage Supervisor, push-pull, -40°C to +125°C, SOT-23B-3 package.</p> <p>b) MCP103T-475E/LB: Tape and Reel, 4.75V MicroPower Voltage Supervisor, push-pull, -40°C to +125°C, SC-70-3 package.</p> <p>a) MCP121T-315I/LB: Tape and Reel, 3.15V MicroPower Voltage Supervisor, open-drain, -40°C to +125°C, SC-70-3 package.</p> <p>b) MCP121-300E/TO: 3.00V MicroPower Voltage Supervisor, open-drain, -40°C to +125°C, TO-92-3 package.</p> <p>a) MCP131T-195I/TT: Tape and Reel, 1.95V MicroPower Voltage Supervisor, open-drain, -40°C to +85°C, SOT-23B-3 package.</p> <p>b) MCP131-300E/TO: 3.00V MicroPower Voltage Supervisor, open-drain, -40°C to +125°C, TO-92-3 package.</p>

Sales and Support

Data Sheets

Products supported by a preliminary Data Sheet may have an errata sheet describing minor operational differences and recommended workarounds. To determine if an errata sheet exists for a particular device, please contact one of the following:

1. Your local Microchip sales office
2. The Microchip Corporate Literature Center U.S. FAX: (480) 792-7277
3. The Microchip Worldwide Site (www.microchip.com)

Please specify which device, revision of silicon and Data Sheet (include Literature #) you are using.

Customer Notification System

Register on our web site (www.microchip.com) to receive the most current information on our products.

MCP102/103/121/131

NOTES:

Note the following details of the code protection feature on Microchip devices:

- Microchip products meet the specification contained in their particular Microchip Data Sheet.
- Microchip believes that its family of products is one of the most secure families of its kind on the market today, when used in the intended manner and under normal conditions.
- There are dishonest and possibly illegal methods used to breach the code protection feature. All of these methods, to our knowledge, require using the Microchip products in a manner outside the operating specifications contained in Microchip's Data Sheets. Most likely, the person doing so is engaged in theft of intellectual property.
- Microchip is willing to work with the customer who is concerned about the integrity of their code.
- Neither Microchip nor any other semiconductor manufacturer can guarantee the security of their code. Code protection does not mean that we are guaranteeing the product as "unbreakable."

Code protection is constantly evolving. We at Microchip are committed to continuously improving the code protection features of our products. Attempts to break Microchip's code protection feature may be a violation of the Digital Millennium Copyright Act. If such acts allow unauthorized access to your software or other copyrighted work, you may have a right to sue for relief under that Act.

Information contained in this publication regarding device applications and the like is intended through suggestion only and may be superseded by updates. It is your responsibility to ensure that your application meets with your specifications. No representation or warranty is given and no liability is assumed by Microchip Technology Incorporated with respect to the accuracy or use of such information, or infringement of patents or other intellectual property rights arising from such use or otherwise. Use of Microchip's products as critical components in life support systems is not authorized except with express written approval by Microchip. No licenses are conveyed, implicitly or otherwise, under any intellectual property rights.

Trademarks

The Microchip name and logo, the Microchip logo, Accuron, dsPIC, KEELOQ, microID, MPLAB, PIC, PICmicro, PICSTART, PRO MATE, PowerSmart, rfPIC, and SmartShunt are registered trademarks of Microchip Technology Incorporated in the U.S.A. and other countries.

AmpLab, FilterLab, MXDEV, MXLAB, PICMASTER, SEEVAL, SmartSensor and The Embedded Control Solutions Company are registered trademarks of Microchip Technology Incorporated in the U.S.A.

Analog-for-the-Digital Age, Application Maestro, dsPICDEM, dsPICDEM.net, dsPICworks, ECAN, ECONOMONITOR, FanSense, FlexROM, fuzzyLAB, In-Circuit Serial Programming, ICSP, ICEPIC, Migratable Memory, MPASM, MPLIB, MPLINK, MPSIM, PICkit, PICDEM, PICDEM.net, PICLAB, PICtail, PowerCal, PowerInfo, PowerMate, PowerTool, rLAB, rfPICDEM, Select Mode, Smart Serial, SmartTel and Total Endurance are trademarks of Microchip Technology Incorporated in the U.S.A. and other countries.

SQTP is a service mark of Microchip Technology Incorporated in the U.S.A.

All other trademarks mentioned herein are property of their respective companies.

© 2004, Microchip Technology Incorporated, Printed in the U.S.A., All Rights Reserved.

 Printed on recycled paper.

QUALITY MANAGEMENT SYSTEM
CERTIFIED BY DNV
== ISO/TS 16949:2002 ==

Microchip received ISO/TS-16949:2002 quality system certification for its worldwide headquarters, design and wafer fabrication facilities in Chandler and Tempe, Arizona and Mountain View, California in October 2003. The Company's quality system processes and procedures are for its PICmicro® 8-bit MCUs, KEELOQ® code hopping devices, Serial EEPROMs, microperipherals, nonvolatile memory and analog products. In addition, Microchip's quality system for the design and manufacture of development systems is ISO 9001:2000 certified.



WORLDWIDE SALES AND SERVICE

AMERICAS

Corporate Office
2355 West Chandler Blvd.
Chandler, AZ 85224-6199
Tel: 480-792-7200
Fax: 480-792-7277
Technical Support:
http://support.microchip.com
Web Address:
www.microchip.com

Atlanta
Alpharetta, GA
Tel: 770-640-0034
Fax: 770-640-0307

Boston
Westford, MA
Tel: 978-692-3848
Fax: 978-692-3821

Chicago
Itasca, IL
Tel: 630-285-0071
Fax: 630-285-0075

Dallas
Addison, TX
Tel: 972-818-7423
Fax: 972-818-2924

Detroit
Farmington Hills, MI
Tel: 248-538-2250
Fax: 248-538-2260

Kokomo
Kokomo, IN
Tel: 765-864-8360
Fax: 765-864-8387

Los Angeles
Mission Viejo, CA
Tel: 949-462-9523
Fax: 949-462-9608

San Jose
Mountain View, CA
Tel: 650-215-1444
Fax: 650-961-0286

Toronto
Mississauga, Ontario,
Canada
Tel: 905-673-0699
Fax: 905-673-6509

ASIA/PACIFIC

Australia - Sydney
Tel: 61-2-9868-6733
Fax: 61-2-9868-6755

China - Beijing
Tel: 86-10-8528-2100
Fax: 86-10-8528-2104

China - Chengdu
Tel: 86-28-8676-6200
Fax: 86-28-8676-6599

China - Fuzhou
Tel: 86-591-750-3506
Fax: 86-591-750-3521

China - Hong Kong SAR
Tel: 852-2401-1200
Fax: 852-2401-3431

China - Shanghai
Tel: 86-21-5407-5533
Fax: 86-21-5407-5066

China - Shenyang
Tel: 86-24-2334-2829
Fax: 86-24-2334-2393

China - Shenzhen
Tel: 86-755-8203-2660
Fax: 86-755-8203-1760

China - Shunde
Tel: 86-757-2839-5507
Fax: 86-757-2839-5571

China - Qingdao
Tel: 86-532-502-7355
Fax: 86-532-502-7205

ASIA/PACIFIC

India - Bangalore
Tel: 91-80-2229-0061
Fax: 91-80-2229-0062

India - New Delhi
Tel: 91-11-5160-8632
Fax: 91-11-5160-8632

Japan - Kanagawa
Tel: 81-45-471- 6166
Fax: 81-45-471-6122

Korea - Seoul
Tel: 82-2-554-7200
Fax: 82-2-558-5932 or
82-2-558-5934

Singapore
Tel: 65-6334-8870
Fax: 65-6334-8850

Taiwan - Kaohsiung
Tel: 886-7-536-4818
Fax: 886-7-536-4803

Taiwan - Taipei
Tel: 886-2-2500-6610
Fax: 886-2-2508-0102

Taiwan - Hsinchu
Tel: 886-3-572-9526
Fax: 886-3-572-6459

EUROPE

Austria - Weis
Tel: 43-7242-2244-399
Fax: 43-7242-2244-393

Denmark - Ballerup
Tel: 45-4420-9895
Fax: 45-4420-9910

France - Massy
Tel: 33-1-69-53-63-20
Fax: 33-1-69-30-90-79

Germany - Ismaning
Tel: 49-89-627-144-0
Fax: 49-89-627-144-44

Italy - Milan
Tel: 39-0331-742611
Fax: 39-0331-466781

Netherlands - Drunen
Tel: 31-416-690399
Fax: 31-416-690340

England - Berkshire
Tel: 44-118-921-5869
Fax: 44-118-921-5820

09/27/04