

**PLEASE CHECK WWW.MOLEX.COM FOR LATEST PART INFORMATION**

**Part Number:** [0428788984](#)  
**Status:** **Active**  
**Overview:** [modular\\_plugs\\_jacks](#)  
**Description:** Modular Jack, Vertical, Low Profile, 8/4, Panel Stops

**Documents:**

[3D Model](#) [Product Specification PS-42878 \(PDF\)](#)  
[Drawing \(PDF\)](#) [RoHS Certificate of Compliance \(PDF\)](#)

**Agency Certification**

CSA LR19980  
 UL E107635

**General**

Product Family Modular Jacks/Plugs  
 Series [42878](#)  
 Comments Flush Mount|Flangeless|2 PCB Thick  
 Component Type PCB Jack  
 Magnetic No  
 Overview [modular\\_plugs\\_jacks](#)  
 Performance Category 3  
 Power over Ethernet (PoE) N/A  
 Product Name RJ45

**Physical**

Boot Color N/A  
 Color - Resin Black  
 Durability (mating cycles max) 500  
 Flammability 94V-0  
 Inverted / Top Latch N/A  
 Lightpipes/LEDs None  
 Material - Metal Phosphor Bronze  
 Material - Plating Mating Gold  
 Material - Plating Termination Tin  
 Material - Resin Polyester  
 Orientation Vertical (Top Entry)  
 PCB Locator Yes  
 PCB Retention Yes  
 PCB Thickness Recommended (in) 0.062 In  
 PCB Thickness Recommended (mm) 1.57 mm  
 Packaging Type Tray  
 Pitch - Mating Interface (in) 0.040 In  
 Pitch - Mating Interface (mm) 1.02 mm  
 Pitch - Term. Interface (in) 0.050 In  
 Pitch - Term. Interface (mm) 1.27 mm  
 Plating min: Mating (µin) 50  
 Plating min: Mating (µm) 1.25  
 Plating min: Termination (µin) 100  
 Plating min: Termination (µm) 2.5  
 Ports 1  
 Positions / Loaded Contacts 8/4  
 Surface Mount Compatible (SMC) No  
 Temperature Range - Operating -40°C to +85°C  
 Termination Interface: Style Through Hole  
 Waterproof / Dustproof No  
 Wire/Cable Type N/A

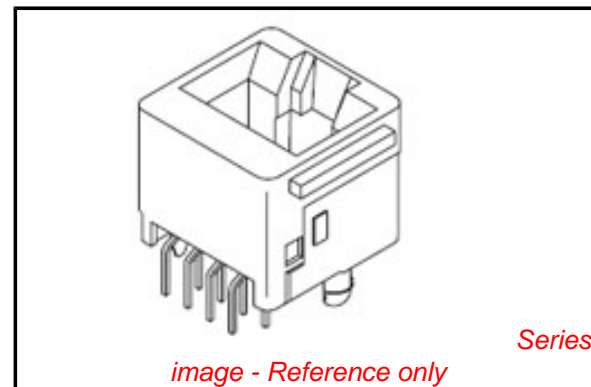

**EU RoHS**

**ELV and RoHS  
 Compliant**  
**REACH SVHC**  
 Not Reviewed  
**Halogen-Free  
 Status**  
 Not Reviewed

**China RoHS**



**Need more information on product  
 environmental compliance?**

Email [productcompliance@molex.com](mailto:productcompliance@molex.com)  
 For a multiple part number RoHS Certificate of  
 Compliance, [click here](#)

Please visit the [Contact Us](#) section for any  
 non-product compliance questions.

**Search Parts in this Series**

[42878Series](#)

**Mates With**

FCC 68 Plugs

**Electrical**

Current - Maximum per Contact	1.5A
Shielded	No
Voltage - Maximum	150V AC (RMS)

**Solder Process Data**

Duration at Max. Process Temperature (seconds)	5
Lead-free Process Capability	Wave Capable (TH only)
Max. Cycles at Max. Process Temperature	1
Process Temperature max. C	235

**Material Info****Reference - Drawing Numbers**

Packaging Specification	PK-42878-492
Product Specification	PS-42878
Sales Drawing	SDA-42878-****
Test Summary	TS-42878-001

This document was generated on 06/07/2010

**PLEASE CHECK [WWW.MOLEX.COM](http://WWW.MOLEX.COM) FOR LATEST PART INFORMATION**

MODULAR JACK CHARACTERISTICS LEGEND	
EXTERNAL CONNECTOR BODY DIMENSIONS: (SEE NOTES 8 AND 9) JACKS ARE AVAILABLE IN STANDARD 4, 6, AND 8 POSITION BODY SIZES	
NUMBER OF CONTACT POSITIONS: CONNECTOR SIZE 4 CAN ACCOMMODATE 2 OR 4 TERMINALS, CONNECTOR SIZE 6 CAN ACCOMMODATE 2, 4, OR 6 TERMINALS, CONNECTOR SIZE 8 CAN ACCOMMODATE 2, 4, 6, 8, OR 10 TERMINALS	
POLARIZATION OPTION: "NO"= JACKS WITHOUT KEYING SLOT "YES"= JACKS WITH KEYING SLOT (AVAILABLE ON CONNECTOR SIZE 8 ONLY)	
MOUNTING EARS OPTION: "YES"= JACKS WITH MOUNTING EARS "NO"= JACKS WITHOUT MOUNTING EARS	

- NOTES:
- 1) MATERIALS: HOUSING- POLYESTER, GLASS FILLED, UL94V-0, COLOR - BLACK  
TERMINALS- PHOSPHOR BRONZE ALLOY, .015/(0.38) THICK.
  - 2) TERMINAL PLATING:  
SELECT GOLD IN CONTACT AREA: 50 MICRONS MIN.  
\*SELECT TIN IN PC TAIL AREA: 100 MICRONS MIN.  
WITH OVERALL NICKEL UNDERPLATE: 50 MICRONS MIN.  
\*THE PRIMARY SHIPPING CARTON WILL BE LABELED "COMPLIANT TO ROHS DIRECTIVE 2002/95/EC AND ELV ANNEX II OF DIRECTIVE 2000/53/EC". CARTONS WITHOUT THIS LABEL MAY CONTAIN PRODUCT WITH TIN-LEAD IN THE PC TAIL.
  - 3) THESE MODULAR JACKS MEET THE PERFORMANCE REQUIREMENTS OF MOLEX PRODUCT SPECIFICATION PS-42878.
  - 4) CONNECTORS ARE SHIPPED IN THERMOFORMED TRAYS, PER PACKAGING SPECIFICATION PK-42878-492.
  - 5) ALL JACKS ARE DESIGNED TO BE USED WITH .062/(1.57) OR .125/(3.18) THICK P.C. BOARDS.
  - 6) ALL JACKS CONFORM TO AND ACCEPT PLUGS WHICH CONFORM TO FCC RULES AND REGULATIONS PART 68, SUBPART E.
  - 7) ALL JACKS MUST BE CAPABLE OF FITTING INTO MOLEX GAGE G-42410 (CONNECTOR SIZE 8).
  - 8) SEE SHEETS 1 & 4 FOR CONNECTOR SIZE 4.
  - 9) SEE SHEETS 2 & 4 FOR CONNECTOR SIZE 6.
  - 10) ENGRAVED NUMBERS ON HOUSING BODY ARE FOR MOLDING IDENTIFICATION ONLY, THEY ARE NOT INTENDED FOR ASSEMBLY IDENTIFICATION PURPOSES.
  - 11) THIS PART CONFORMS TO CLASS B REQUIREMENTS OF COSMETIC SPECIFICATION PS-45499-002 WITH THE EXCEPTION OF THE SINK WHICH CONFORMS TO CLASS C REQUIREMENTS.

P.C. BOARD THICKNESS	DIM. "D" (MTG. PEGS)	DIM. "F" (P.C. TAILS)
.062/(1.57)	.128 (3.25)	.120 +.015/-0.25 (3.05 +.38/-6.3)
.125/(3.18)	.191 (4.85)	.205 +.015/-0.25 (5.21 +.38/-6.3)

CONNECTOR SIZE	CIRCUIT SIZE	DIM. "G"
8	10	.450 (11.43)
8	8	.350 (8.89)
8	6	.250 (6.35)
8	4	.150 (3.81)
8	2	.050 (1.27)

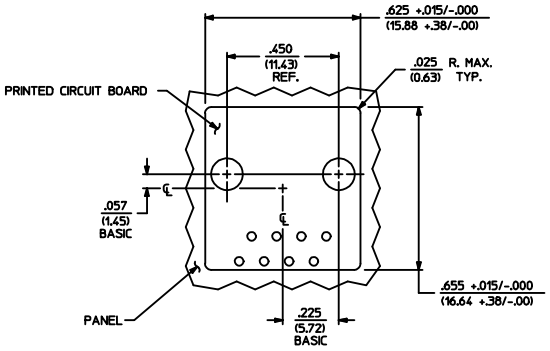
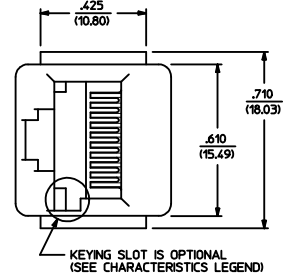

PANEL CUT-OUT FOR CONNECTOR SIZE 8

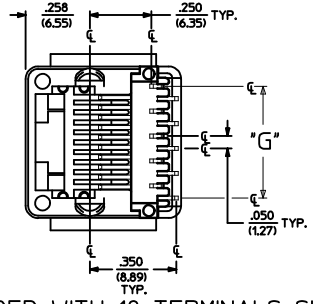
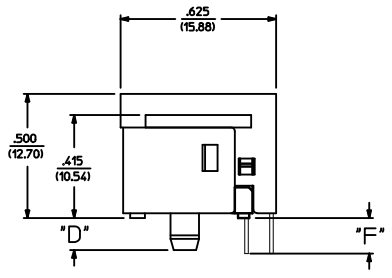
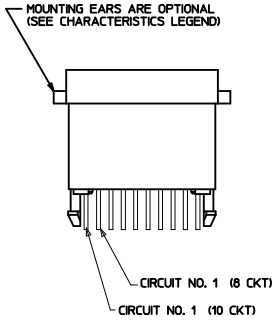

SIZE 8 MODULAR JACK LOADED WITH 10 TERMINALS SHOWN ABOVE

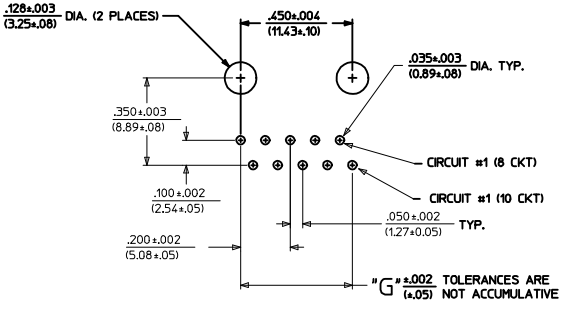

P.C. BOARD LAYOUT FOR CONNECTOR SIZE 8  
10 CIRCUIT SHOWN

ADD COSMETIC SPEC EC NO. UCP2009-1267 H2	QUALITY SYMBOLS =0 =0	GENERAL TOLERANCES (UNLESS SPECIFIED)		DIMENSION STYLE		SCALE	DESIGN UNITS	THIRD ANGLE PROJECTION	
		mm	INCH	IN/MM		1:1	INCH	INCH	
DRAWN: J. KOSTENLER 2008/12/01 CHKD: J. BELL 2008/12/02 APPR: F. SMITH 2008/12/02	DESCRIPTION	4 PLACES	± .010	DRAWN BY	DATE	1:1	INCH	ASSEMBLY, VERTICAL LOW PROFILE MODULAR JACKS (CONNECTOR SIZE 8)	
		3 PLACES	± .010	BAP	1992/04/09				
		2 PLACES	± 0.25	CHECKED BY	DATE			MOLEX INCORPORATED	
		1 PLACE	± .010	BAP	1992/04/09				
		ANGULAR ±1/2°		APPROVED BY	DATE			MOLEX INCORPORATED	
		ANGULAR ±1/2°		RAS	1992/04/09				
		DRAFT WHERE APPLICABLE MUST REMAIN WITHIN DIMENSIONS		MATERIAL NO.		DOCUMENT NO.		SHEET NO.	
				SEE SHEET 5		SDA-42878-****		3 OF 5	
				THIS DRAWING CONTAINS INFORMATION THAT IS PROPRIETARY TO MOLEX INCORPORATED AND SHOULD NOT BE USED WITHOUT WRITTEN PERMISSION					

M	PART CHARACTERISTICS						M
	ASSEMBLY ITEM NUMBER	EXTERNAL CONNECTOR SIZE	NUMBER OF POSITIONS	P. C. BOARD THICKNESS	POLARIZATION OPTION	MOUNTING EARS OPTION	
L	42878-8408	8 POS. BODY	8	.062	NO	YES	
	42878-8410	↑	↑	↑	NO	NO	
	42878-8456	↑	↑	↓	YES	YES	
	42878-8458	↑	↑	.062	YES	NO	
	42878-8504	↑	↑	.125	NO	YES	
	42878-8506	↑	↑	↑	NO	NO	
	42878-8552	↑	↑	↑	YES	YES	
K	42878-8554	8	.125	YES	NO		
	42878-8696	6	.062	NO	YES		
	42878-8698	↑	↑	NO	NO		
	42878-8744	↑	↑	YES	YES		
	42878-8746	↑	.062	YES	NO		
J	42878-8792	↑	.125	NO	YES		
	42878-8794	↑	↑	NO	NO		
	42878-8840	↑	↑	YES	YES		
I	42878-8842	8 POS. BODY	6	.125	YES	NO	

M	PART CHARACTERISTICS						M
	ASSEMBLY ITEM NUMBER	EXTERNAL CONNECTOR SIZE	NUMBER OF POSITIONS	BOARD THICKNESS/P.C. TAIL OPTION	POLARIZATION OPTION	MOUNTING EARS OPTION	
L	42878-8984	8 POS. BODY	4	.062	NO	YES	
	42878-8986	↑	↑	↑	NO	NO	
	42878-9032	↑	↑	↓	YES	YES	
	42878-9034	↑	↑	.062	YES	NO	
	42878-9080	↑	↑	.125	NO	YES	
	42878-9082	↑	↑	↑	NO	NO	
	42878-9128	↑	↑	↓	YES	YES	
	42878-9130	4	.125	YES	NO		
	42878-9272	2	.062	NO	YES		
	42878-9274	↑	↑	NO	NO		
	42878-9320	↑	↑	YES	YES		
	42878-9322	↑	.062	YES	NO		
	42878-9368	↑	.125	NO	YES		
	42878-9370	↑	↑	NO	NO		
	42878-9416	↑	↑	YES	YES		
I	42878-9418	8 POS. BODY	2	.125	YES	NO	

M	PART CHARACTERISTICS						M
	ASSEMBLY ITEM NUMBER	EXTERNAL CONNECTOR SIZE	NUMBER OF POSITIONS	BOARD THICKNESS/P.C. TAIL OPTION	POLARIZATION OPTION	MOUNTING EARS OPTION	
L	42878-1001	8 POS. BODY	10	.062	NO	YES	
	42878-1003	↑	↑	.062	NO	NO	
	42878-1025	↑	↑	.125	NO	YES	
	42878-1027	↑	↑	↑	NO	NO	
	42878-1037	↓	↓	↓	YES	YES	
	42878-1039	8 POS. BODY	10	.125	YES	NO	

CHARACTERISTICS LEGEND	
EXTERNAL CONNECTOR BODY DIMENSIONS: AVAILABLE IN 4, 6, AND 8 POSITION BODY	
NUMBER OF CONTACT POSITIONS: CONNECTOR SIZE 4 ACCOMMODATES 2, OR 4 TERMINALS, CONNECTOR SIZE 6 ACCOMMODATES 2, 4, OR 6 TERMINALS, CONNECTOR SIZE 8 ACCOMMODATES 2, 4, 6, 8, OR 10 TERMINALS	
POLARIZATION OPTION: (AVAILABLE ON CONNECTOR SIZE 8 ONLY) "NO" - WITHOUT KEYING SLOT "YES" - WITH KEYING SLOT	
MOUNTING EARS OPTION: "YES" - PART WITH MOUNTING EARS "NO" - PART WITHOUT MOUNTING EARS	
(SEE SHEET 3 FOR PART DESCRIPTIONS AND DIMENSIONS)	

SEE SHEET ONE EC NO: UCP2004-667 DRW:LSCHMIDT 2004/03/03 CHK:LSCHMIDT 2004/03/03 APPR:ESMITH 2004/03/03	QUALITY SYMBOLS	GENERAL TOLERANCES (UNLESS SPECIFIED)	SCALE	DESIGN UNITS	THIRD ANGLE PROJECTION	REVISE ON CAD ONLY
	▽ 0	mm INCH	---	INCH	ASSEMBLY, VERTICAL LOW PROFILE MODULAR JACKS (CONNECTOR SIZE 8)	
	▽ 0	4 PLACES ± --- ± --- 3 PLACES ± --- ± --- 2 PLACES ± --- ± --- 1 PLACE ± --- ± ---	IN/MM	DRAWN BY DATE BAP 1992/04/09	MATERIAL NO. (DOCUMENT NO.) MOLEX INCORPORATED (SDA-42878-****)	
		ANGULAR ±1/2° DRAFT WHERE APPLICABLE MUST REMAIN WITHIN DIMENSIONS		CHECKED BY DATE BAP 1992/04/09	SHEET NO. 5 OF 5	
			APPROVED BY DATE RAS 1992/04/09	THIS DRAWING CONTAINS INFORMATION THAT IS PROPRIETARY TO MOLEX INCORPORATED AND SHOULD NOT BE USED WITHOUT WRITTEN PERMISSION		