

RoHS Compliant Product  
A suffix of "-C" specifies halogen & lead-free

## FEATURES

- High  $h_{FE}$
- Low noise
- Complementary to KTA1504

## CLASSIFICATION OF $h_{FE}$

Product-Rank	KTC3875-O	KTC3875-Y	KTC3875-GR	KTC3875-BL
Range	70~140	120~240	200~400	350~700
Marking Code	ALO	ALY	ALG	ALL

## PACKAGE INFORMATION

Package	MPQ	Leader Size
SOT-23	3K	7 inch

## SOT-23

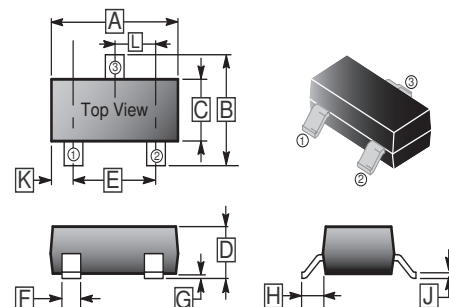

REF.	Millimeter		REF.	Millimeter	
	Min.	Max.		Min.	Max.
A	2.80	3.04	G	0.09	0.18
B	2.10	2.55	H	0.45	0.60
C	1.20	1.40	J	0.08	0.177
D	0.89	1.15	K	0.6 REF.	
E	1.78	2.04	L	0.89	1.02
F	0.30	0.50			

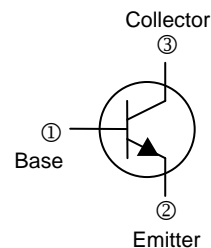

## ABSOLUTE MAXIMUM RATINGS ( $T_A=25^\circ\text{C}$ unless otherwise specified)

Parameter	Symbol	Ratings	Unit
Collector to Base Voltage	$V_{CBO}$	60	V
Collector to Emitter Voltage	$V_{CEO}$	50	V
Emitter to Base Voltage	$V_{EBO}$	5	V
Collector Current - Continuous	$I_C$	150	mA
Collector Power Dissipation	$P_C$	150	mW
Junction, Storage Temperature	$T_J, T_{STG}$	150, -55~150	$^\circ\text{C}$

## ELECTRICAL CHARACTERISTICS ( $T_A=25^\circ\text{C}$ unless otherwise specified)

Parameter	Symbol	Min.	Typ.	Max.	Unit	Test Conditions
Collector to Base Breakdown Voltage	$V_{(BR)CBO}$	60	-	-	V	$I_C=100\mu\text{A}, I_E=0$
Collector to Emitter Breakdown Voltage	$V_{(BR)CEO}$	50	-	-	V	$I_C=1\text{mA}, I_B=0$
Emitter to Base Breakdown Voltage	$V_{(BR)EBO}$	5	-	-	V	$I_E=100\mu\text{A}, I_C=0$
Collector Cut-Off Current	$I_{CBO}$	-	-	0.1	$\mu\text{A}$	$V_{CB}=60\text{V}, I_E=0$
Emitter Cut-Off Current	$I_{EBO}$	-	-	0.1	$\mu\text{A}$	$V_{EB}=5\text{V}, I_C=0$
DC Current Gain	$h_{FE}$	70	-	700		$V_{CE}=6\text{V}, I_C=2\text{mA}$
Collector to Emitter Saturation Voltage	$V_{CE(sat)}$	-	0.1	0.25	V	$I_C=100\text{mA}, I_B=10\text{mA}$
Base to Emitter Saturation Voltage	$V_{BE(sat)}$	-	-	1	V	$I_C=100\text{mA}, I_B=10\text{mA}$
Transition Frequency	$f_T$	80	-	-	MHz	$V_{CE}=10\text{V}, I_C=1\text{mA}$
Collector output capacitance	$C_{ob}$	-	2.0	3.5	pF	$V_{CB}=10\text{V}, I_E=0, f=1\text{MHz}$
Noise figure	NF	-	1	10	dB	$V_{CE}=6\text{V}, I_C=0.1\text{mA}, R_g=10\text{k}\Omega, f=1\text{KHz}$

**CHARACTERISTIC CURVES**

$I_C - V_{CE}$

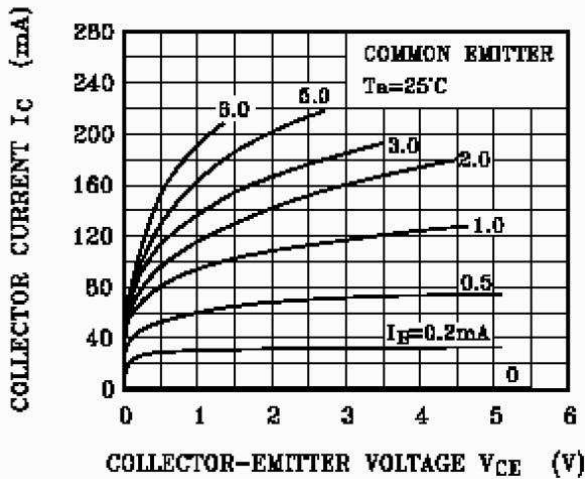

$h_{FE} - I_C$

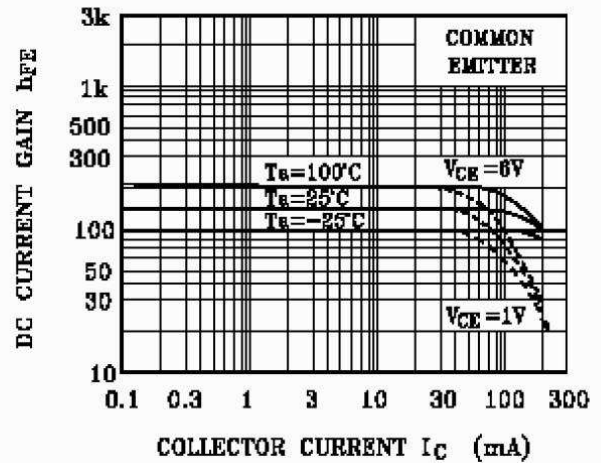

$V_{CE(sat)} - I_C$

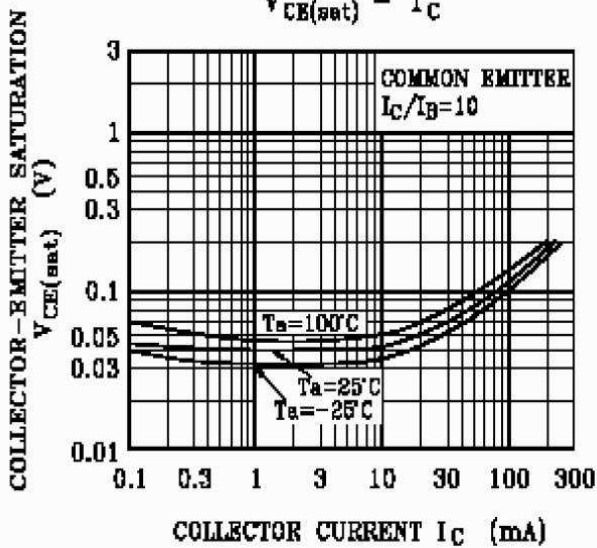

$V_{BE(sat)} - I_C$

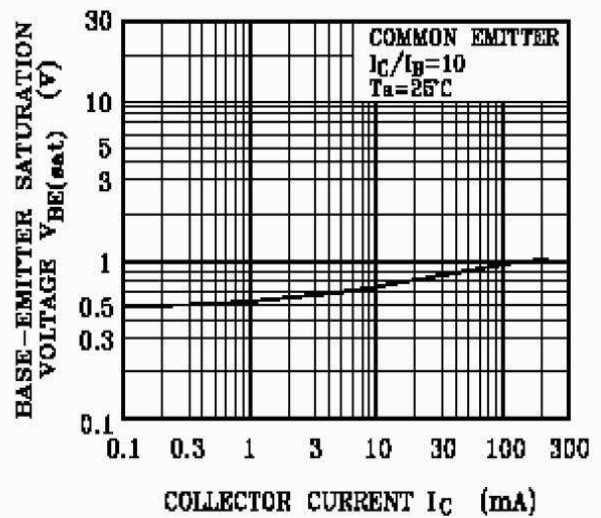

$f_T - I_E$

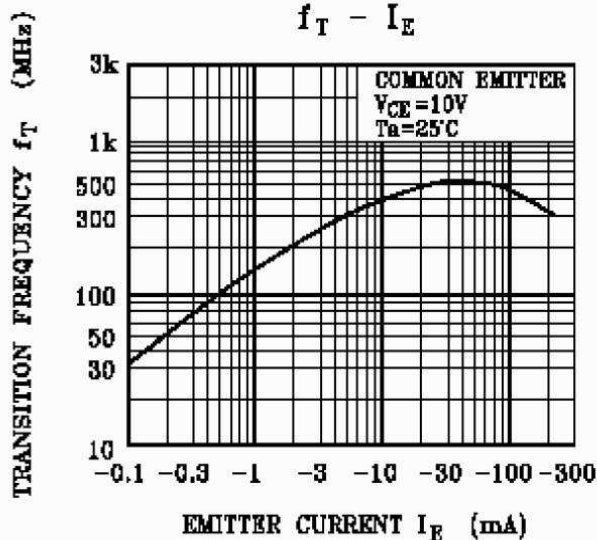

$I_B - V_{BE}$

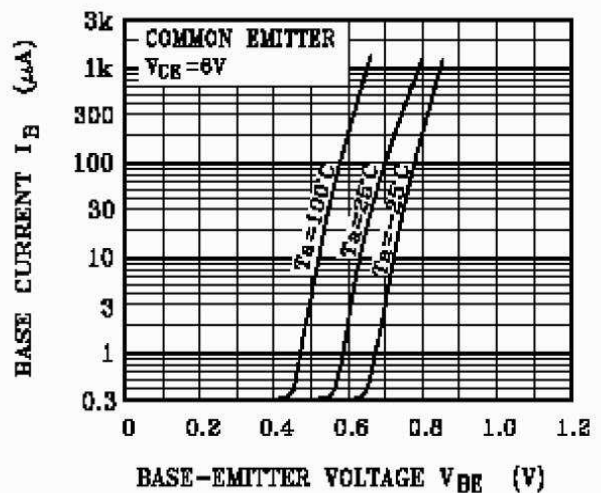

**CHARACTERISTIC CURVES**

**h PARAMETER -  $I_C$**

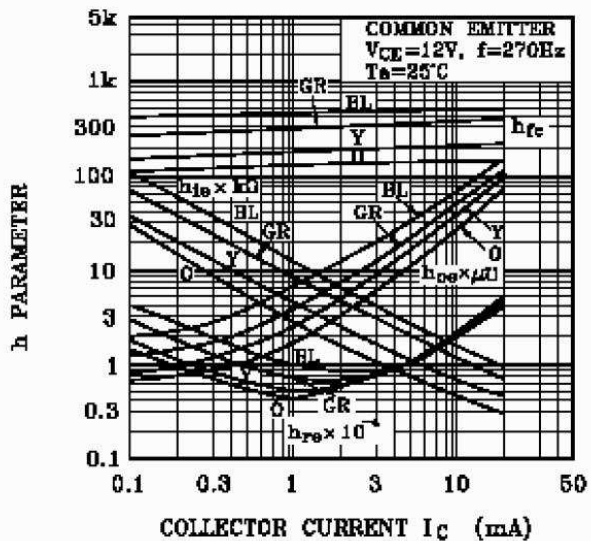

**h PARAMETER -  $V_{CE}$**

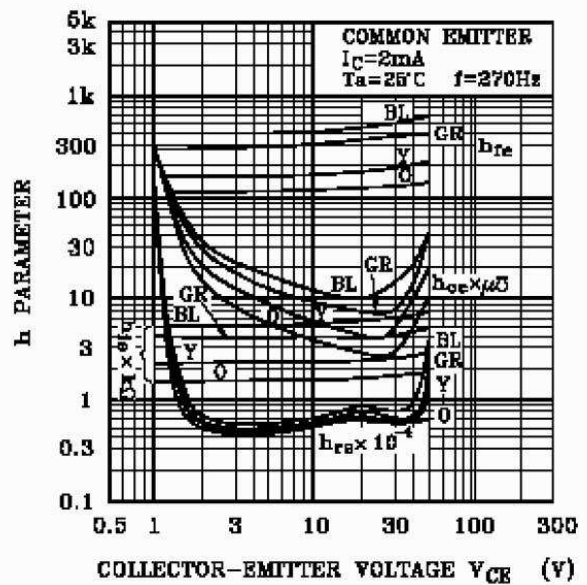

**$P_C$  -  $T_a$**

