



Dual EIA-422/423 Transceivers

The MC34050/51 are dual transceivers which comply with EIA Standards EIA-422 (Balanced line) and EIA-423 (Unbalanced line). Each device contains two drivers and two receivers.

The MC34050 has a DRIVER ENABLE (for both drivers) and a RECEIVER ENABLE (for both receivers). Connecting the two ENABLES together provides Driver-to-Receiver switching from a single line.

The MC34051 has a DRIVER ENABLE for each driver. The two receivers are permanently enabled.

The Driver inputs, Receiver outputs, and Enable inputs are 74LS TTL compatible.

- Two Independent Drivers and Receivers Per Package
- 3-State Outputs
- Single 5.0 V Supply
- Internal Hysteresis (50 mV Typical) on Receivers
- Receivers Provide Fail-Safe Function. Output Stays High if Inputs are Open, Shorted (floating), or Terminated (floating)
- Receivers May Be Used in EIA-422 or 423 Systems
- Drivers Meet Full EIA-422 Standards

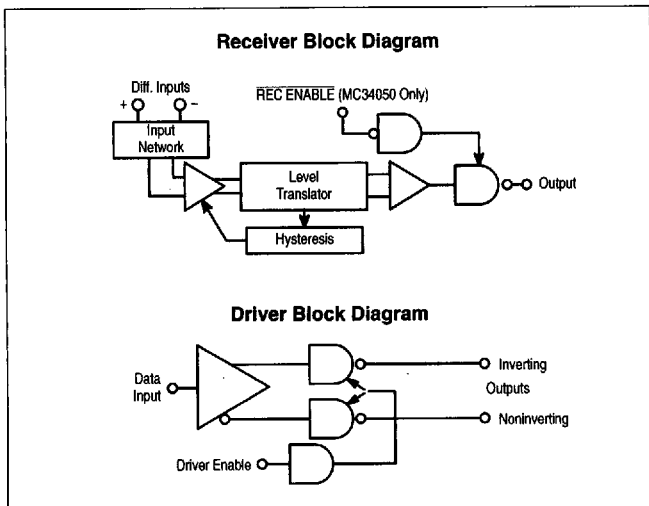

TRUTH TABLE

Driver				Receiver		
Data	EN	Inv. Out	Noninv. Out	Input	EN	Output
L	H	H	L	> +0.2 V Diff.	L	H
H	H	L	H	< -0.2 V Diff.	L	L
X	L	Z	Z	X	H	Z

MC34050 MC34051

DUAL EIA-422/423 TRANSCIVERS

SEMICONDUCTOR
TECHNICAL DATA

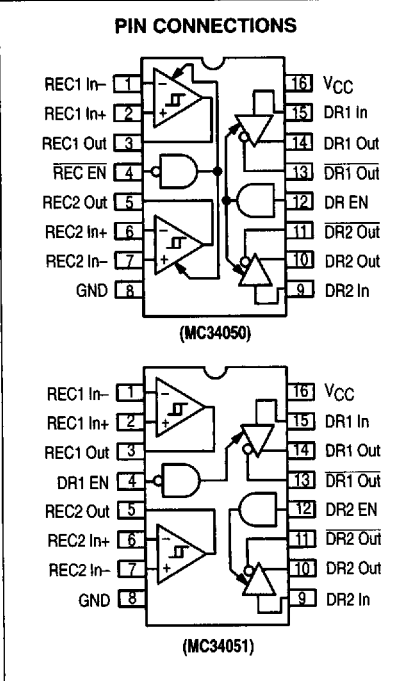
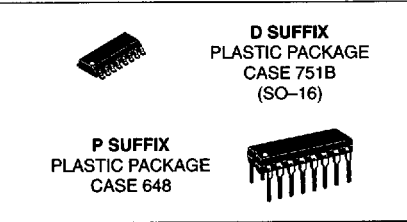

7

ORDERING INFORMATION

Device	Operating Temperature Range	Package
MC34050D	T _A = 0° to +70°C	SO-16
MC34050P		Plastic DIP
MC34051P		Plastic DIP
MC34051D		SO-16

MC34050 MC34051

MAXIMUM RATINGS

Rating	Value	Units
Power Supply Voltage (V_{CC})	7.0	Vdc
Input Common Mode Voltage (Receivers)	± 25	Vdc
Input Differential Voltage (Receivers)	± 25	Vdc
Output Sink Current (Receivers)	50	mA
Enable Input Voltage (Drivers and Receivers)	5.5	Vdc
Input Voltage (Drivers)	5.5	Vdc
Applied Output Voltage (3-State mode) – Receivers	-1.0 to +7.0	Vdc
Applied Output Voltage (3-State mode) – Drivers	-1.0 to +7.0	Vdc
Junction Temperature	-65 to +150	$^{\circ}\text{C}$
Storage Temperature	-65 to +150	$^{\circ}\text{C}$

Devices should not be operated at these values.
The "Recommended Operating Limits" provide for actual device operation.

RECOMMENDED OPERATING LIMITS

Characteristic	Min	Typ	Max	Unit
Power Supply Voltage	+4.75	+5.0	+5.25	Vdc
Input Common Mode Voltage (Receivers)	-7.0	-	+7.0	Vdc
Input Differential Voltage (Receivers)	-6.0	-	+6.0	Vdc
Enable Input Voltage (Drivers and Receivers)	0	-	+5.25	Vdc
Input Voltage (Drivers)	0	-	+5.25	Vdc
Ambient Temperature Range	0	-	+70	$^{\circ}\text{C}$

ELECTRICAL CHARACTERISTICS (Unless otherwise noted, specifications apply for $4.75 < V_{CC} < 5.25$ V, and $0^{\circ} < T_A < 70^{\circ}\text{C}$).

Characteristic	Symbol	Min	Typ	Max	Unit
----------------	--------	-----	-----	-----	------

DRIVERS

Input Voltage – Low	V_{ILD}	-	-	0.8	Vdc
Input Voltage – High	V_{IHD}	2.0	-	-	Vdc
Input Current @ $V_{IL} = 0.4$ V	I_{ILD}	-360	-	-	μA
Input Current @ $V_{IH} = 2.7$ V $V_{IH} = 5.25$ V	I_{IHD}	-	-	+20 +100	μA
Input Clamp Voltage ($I_{IK} = -18$ mA)	V_{IKD}	-1.5	-	-	Vdc
Output Voltage – Low ($I_{OL} = 20$ mA)	V_{OLD}	-	-	0.5	Vdc
Output Voltage – High ($I_{OH} = -20$ mA)	V_{OHD}	2.5	-	-	Vdc
Output Offset Voltage Difference (Note 1)	V_{OSD}	-0.4	-	+0.4	Vdc
Output Differential Voltage (Note 1)	V_T	2.0	-	-	Vdc
Output Differential Voltage Difference (Note 1)	V_{TD}	-0.4	-	+0.4	Vdc
Short Circuit Current ($V_{CC} = 5.25$ V) (From High Output, Note 2)	I_{OSD}	-150	-	-30	mA
Output Leakage Current – HI-Z State ($V_{out} = 0.5$ V, DR EN = 0.8 V) ($V_{out} = 2.7$ V, DR EN = 0.8 V)	I_{OZD}	-100 -100	- -	+100 +100	μA
Output Leakage – Power Off ($V_{out} = -0.25$ V, $V_{CC} = 0$ V) ($V_{out} = 6.0$ V, $V_{CC} = 0$ V)	$I_{O(off)}$	-100 -	- -	- +100	μA

NOTES: 1. See EIA Standard EIA-422 and Figure 1 for exact test conditions.
2. Only one output in a package should be shorted at a time, for no longer than 1 second.

MC34050 MC34051

ELECTRICAL CHARACTERISTICS (Unless otherwise noted, specifications apply for $4.75 < V_{CC} < 5.25$ V, and $0^\circ < T_A < 70^\circ$ C).

Characteristic	Symbol	Min	Typ	Max	Unit
----------------	--------	-----	-----	-----	------

RECEIVERS

Differential Input Threshold Voltage (Note 3) (-7.0 V $< V_{ICM} < 7.0$ V, $V_{out} \geq 2.7$ V) (-7.0 V $< V_{ICM} < 7.0$ V, $V_{out} \leq 0.45$ V)	V_{THR}	– –0.2	– –	+0.2 –	Vdc
Input Bias Current ($0 \leq V_{CC} \leq 5.25$ V, $V_{in} = 15$ V) ($0 \leq V_{CC} \leq 5.25$ V, $V_{in} = -15$ V)	I_{IBR}	– –2.8	– –	+2.3 –	mA
Input Balance and Output Level ($-7.0 \leq V_{ICM} \leq 7.0$ V) ($V_{ID} = 0.4$ V, $I_O = -400$ μ A) ($V_{ID} = -0.4$ V, $I_O = 8.0$ mA)	V_{OHR} V_{OLR}	2.7 –	– –	– 0.45	Vdc
Output Leakage Current – 3-State (Pin 4 = 2.0 V, MC34050 only) ($V_{ID} = 3.0$ V, $V_O = 0.4$ V) ($V_{ID} = -3.0$ V, $V_O = 2.4$ V)	I_{OZR}	–100 –100	– –	+100 +100	μ A
Output Short Circuit Current (Note 2, $V_{CC} = 5.25$ V) ($V_{ID} = 3.0$ V, MC34050 Pin 4 = 0.4 V, $V_O = 0$ V)	I_{OSR}	–85	–	–15	mA

ENABLES

Input Voltage – Low	V_{ILE}	–	–	0.8	Vdc
Input Voltage – High	V_{IHE}	2.0	–	–	Vdc
Input Current @ $V_{IL} = 0.4$ V (Receiver EN) (Driver EN)	I_{ILER} I_{ILED}	–100 –360	– –	– –	μ A
Input Current @ $V_{IH} = 2.7$ V $V_{IH} = 5.25$ V	I_{IHE}	– –	– –	+20 +100	μ A
Input Clamp Voltage ($I_{IK} = -18$ mA)	V_{IKE}	–1.5	–	–	Vdc

POWER SUPPLY

Power Supply Current @ $V_{CC} = 5.25$ V	I_{CC}	–	55	80	mA
--	----------	---	----	----	----

NOTES: 2. Only one output in a package should be shorted at a time, for no longer than 1 second.
3. Differential input threshold voltage and guaranteed output levels are done simultaneously for worst case.

DRIVER SWITCHING CHARACTERISTICS ($V_{CC} = 5.0$ V, $T_A = 25^\circ$ C, see Figure 2).

Characteristic	Symbol	Min	Typ	Max	Unit
Propagation Delay Data Input to Output High-to-Low Data Input to Output Low-to-High Output Skew ($ t_{PHL} - t_{PLH} $ each driver) Enable Input to Output $C_L = 10$ pF, $R_L = 75$ Ω to Gnd $C_L = 10$ pF, $R_L = 180$ Ω to V_{CC} $C_L = 30$ pF, $R_L = 75$ Ω to Gnd $C_L = 30$ pF, $R_L = 180$ Ω to V_{CC}	t_{PHLD} t_{PLHD} t_{SKD} t_{PHZD} t_{PLZD} $t_{PZH D}$ t_{PZLD}	– – – – – – –	– – – – – – –	20 20 8 30 35 40 45	ns
Maximum Data Input Transition Time (10% to 90%)	t_{TRD}	–	50	–	ns

RECEIVER SWITCHING CHARACTERISTICS ($V_{CC} = 5.0$ V, $T_A = 25^\circ$ C, see Figure 3).

Characteristic	Symbol	Min	Typ	Max	Unit
Propagation Delay Differential Input to Output – High-to-Low Differential Input to Output – Low-to-High Enable Input – Output Low to 3-State Enable Input – Output High to 3-State Enable Input – Output 3-State to High Enable Input – Output 3-State to Low	t_{PHLR} t_{PLHR} t_{PLZR} t_{PHZR} t_{PZHR} t_{PZLR}	– – – – – –	– – – – – –	30 30 35 35 30 30	ns
} MC34050 Only					

7

MC34050 MC34051

Figure 1. Driver Output Test Circuit

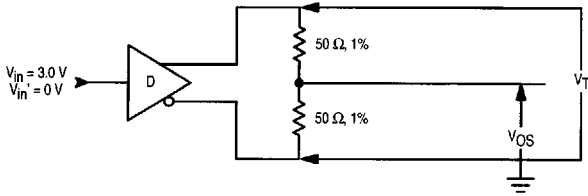

$$V_{OSD} = |V_{OS} - V_{OS}'|;$$

$$V_{ODD} = |V_T| - |V_T'|$$

Circuit per EIA-422-A, Dec. 1978

Figure 2. Driver Switching Test Circuits

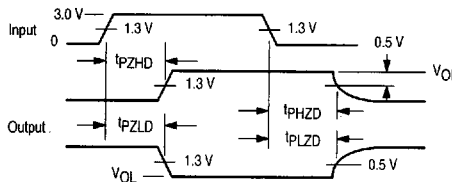
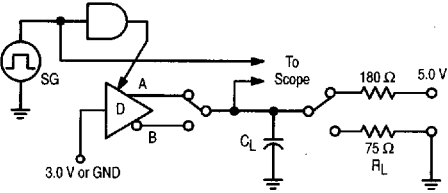
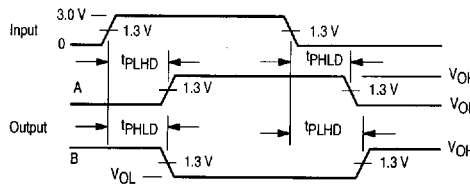
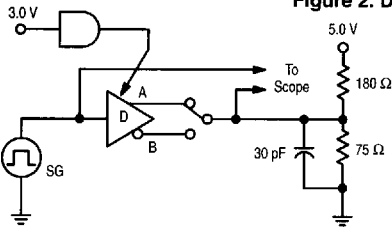

SG: 1.0 MHz, 50% duty cycle, t_R , t_F = 6.0 ns (10% to 90%)
 R_L = 75 Ω to GND for t_{PZHD} and t_{PHZD} ; 180 Ω to V_{CC} for t_{PZLD} and t_{PHLD} ;
 C_L = 10 pF for t_{PHZD} and t_{PLZD} ; 30 pF for t_{PZHD} and t_{PZLD} .

Figure 3. Receiver Switching Test Circuits

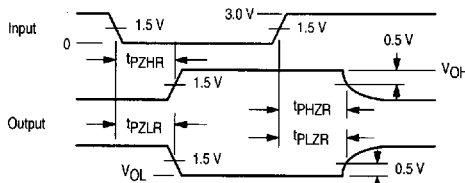
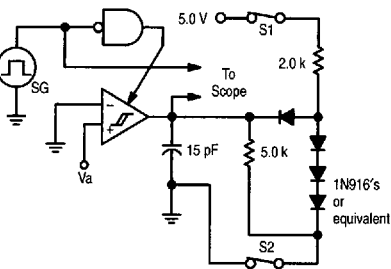
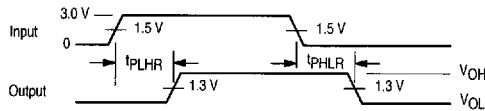
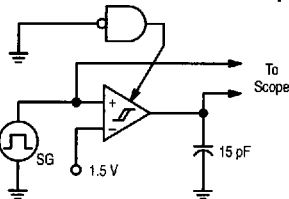

MC34050 Only

SG: 1.0 MHz, 50% duty cycle, t_R , t_F = 6.0 ns (10% to 90%)
 V_a = +1.5 V for t_{PHZ} , t_{PZH} ; V_a = -1.5 V for t_{PLZ} , t_{PZL} ;
 S_1 , S_2 closed for t_{PHZ} , t_{PLZ} ; S_1 open, S_2 closed for t_{PZH} ; S_1 closed, S_2 open for t_{PZL} .

MC34050 MC34051

Figure 4. Driver Input Characteristics

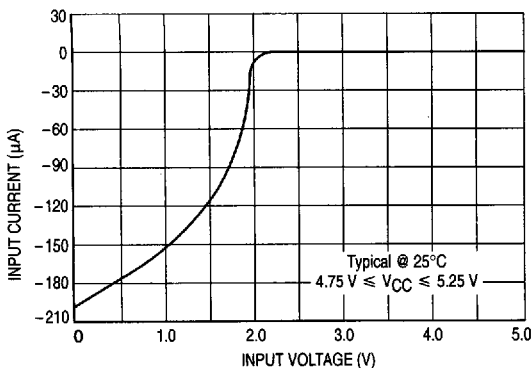

Figure 5. Driver Differential Output Characteristics

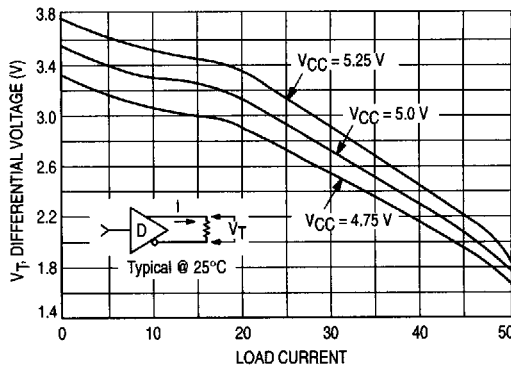

Figure 6. Driver Output Voltage

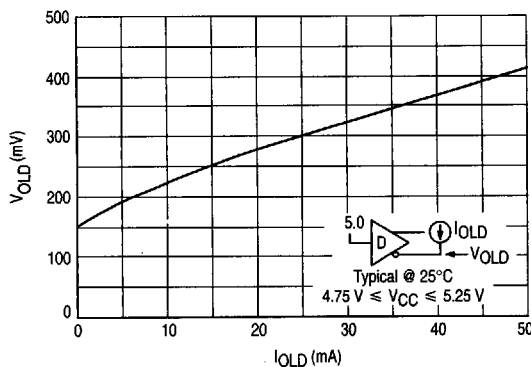

Figure 7. Driver Output Voltage

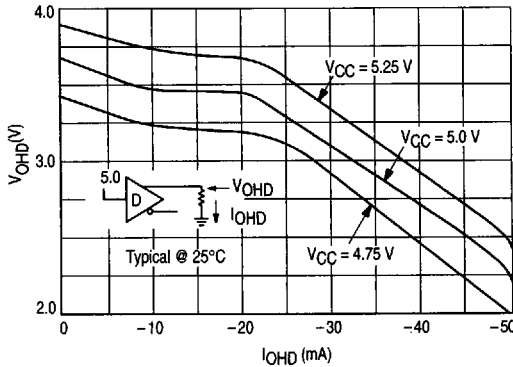

Figure 8. Receiver Output Voltage

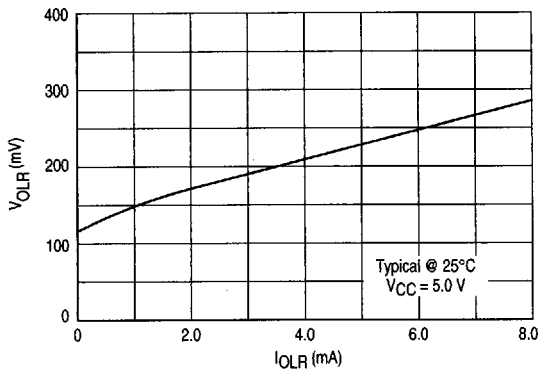
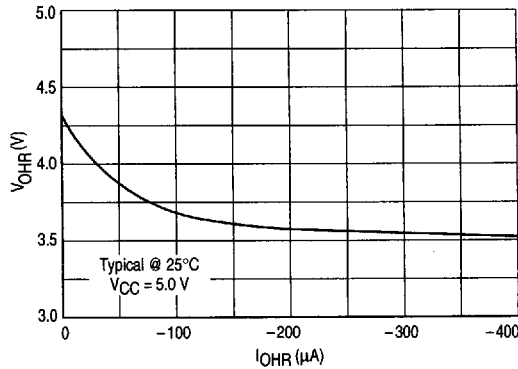

Figure 9. Receiver Output Voltage



7

MC34050 MC34051

Figure 10. Receiver Input Characteristics

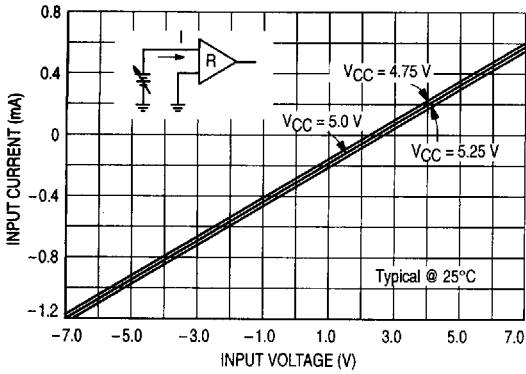

Figure 11. Enable Input Characteristics

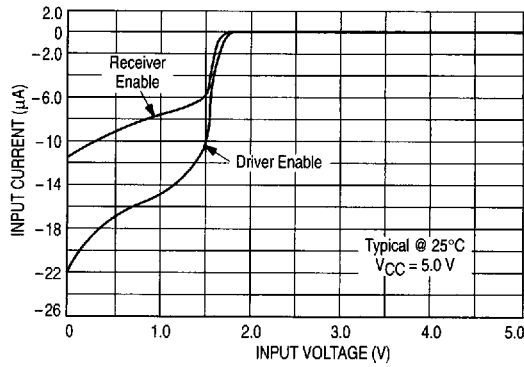

Figure 12. Receiver Input Characteristics

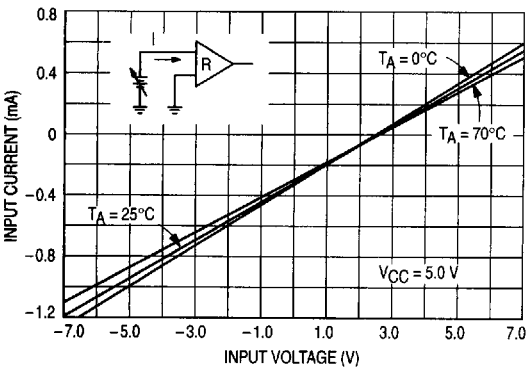

Figure 13. Receiver Output Leakage

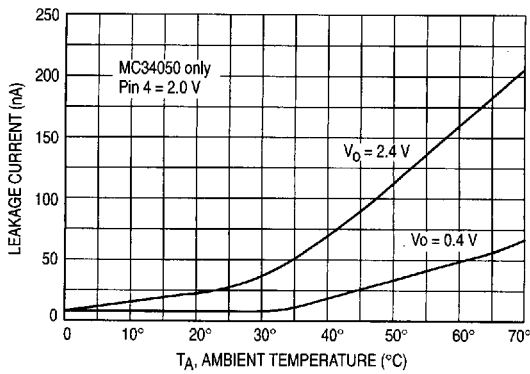

Figure 14. Driver Output Voltage

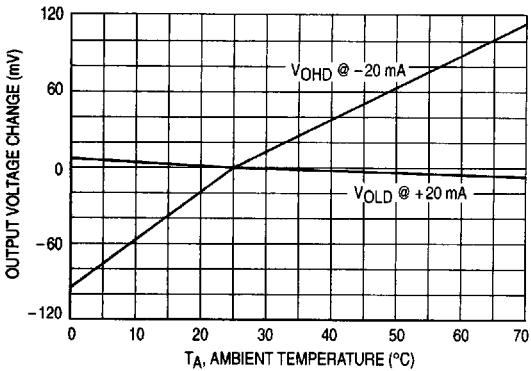
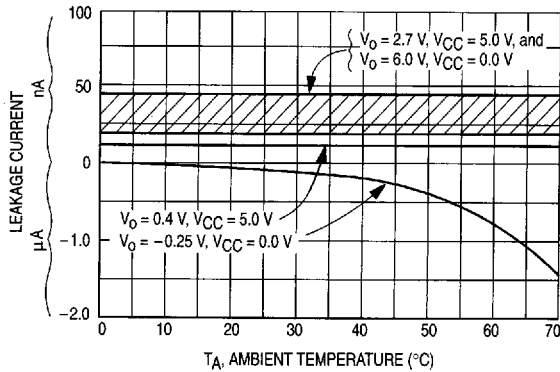

Figure 15. Driver Output Leakage



MC34050 MC34051

Figure 16. EIA-422 Application

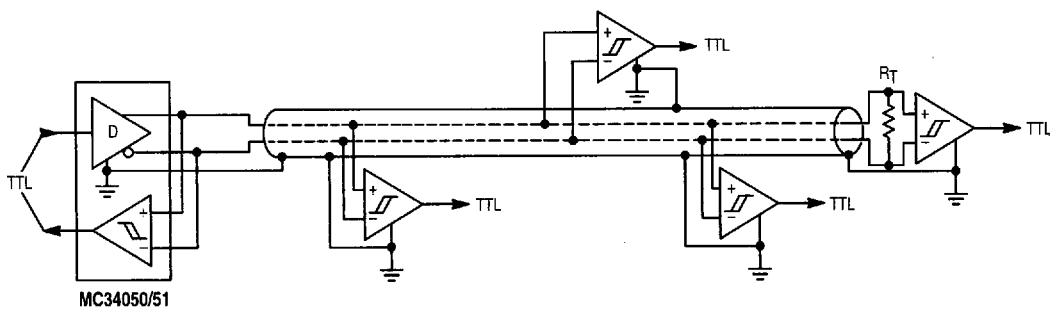
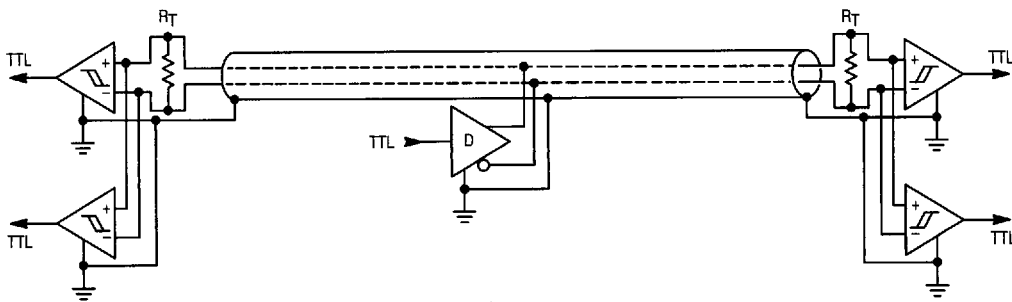

Figure 17. EIA-423 Application



7