

WIDE BAND LOW NOISE AMPLIFIER GaAs MMIC

■ GENERAL DESCRIPTION

The NJG1142KA1 is a wide band low noise amplifier GaAs MMIC designed for mobile TV application. And this amplifier can be tuned to wide frequency (170~1680MHz).

The NJG1142KA1 has a LNA pass-through function to select high gain mode or low gain mode by low control voltage operation. The NJG1142KA1 features low current consumption, high linearity.

An ultra-small and ultra-thin package of FLP6-A1 is adopted.

■ PACKAGE OUTLINE

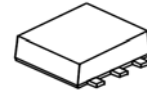

NJG1142KA1

■ FEATURES

- Wide operating frequency range 170MHz~1680MHz
- Low voltage operation 2.8V typ.
- [High gain mode]
 - Low current consumption 6mA typ.
 - High gain +14.0dB typ.
 - Low noise figure 1.5dB typ.
 - High P_{-0.1dB} Compression 0dBm typ.
 - High input IP3 +2.0dBm typ.
- [Low gain mode]
 - Low current consumption 11μA typ.
 - Gain (Low loss) -1.0dB typ.
 - High P_{-0.1dB} Compression +17dBm typ.
 - High input IP3 +22.0dBm typ.
- External components count 3 pcs. (capacitor: 2pcs, inductor: 1pc)
- Small package size FLP6-A1 (package size: 1.6mm x 1.6mm x 0.55mm typ.)
- Lead -free and halogen-free

■ PIN CONFIGURATION

(Top View)

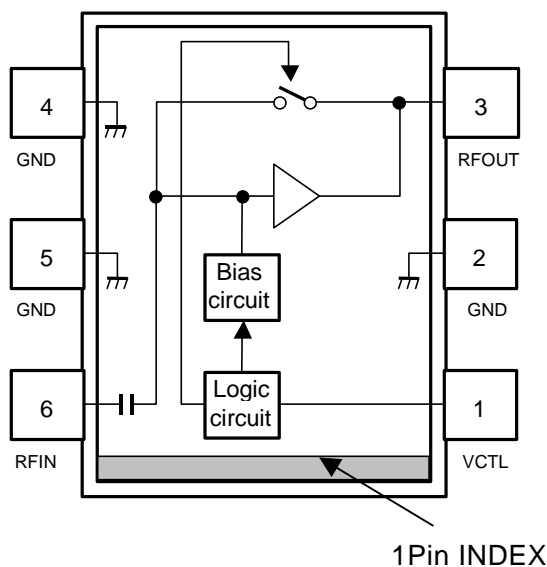

■ PIN CONNECTION

1. VCTL
2. GND
3. RFOUT
4. GND
5. GND
6. RFIN

■ TRUTH TABLE

“H” = V_{CTL(H)} “L” = V_{CTL(L)}

V _{CTL}	LNA Mode
H	High Gain Mode
L	Low Gain Mode

NOTE: The information on this datasheet is subject to change without notice

NJG1142KA1

■ ABSOLUTE MAXIMUM RATINGS

$T_a=+25^{\circ}\text{C}$, $Z_s=Z_l=50\ \text{ohm}$

PARAMETER	SYMBOL	CONDITIONS	RATINGS	UNITS
Supply voltage	V_{DD}		5.0	V
Control voltage	V_{CTL}		5.0	V
Input power	P_{IN}	$V_{DD}=2.8\text{V}$	+15	dBm
Power dissipation	P_D	4-layer FR4 PCB with through-hole (74.2mmx74.2mm), $T_j=150^{\circ}\text{C}$	580	mW
Operating temperature	T_{opr}		-40~+85	$^{\circ}\text{C}$
Storage temperature	T_{stg}		-55~+150	$^{\circ}\text{C}$

■ ELECTRICAL CHARACTERISTICS

DC CHARACTERISTICS

General conditions: $V_{DD}=2.8\text{V}$, $T_a=+25^{\circ}\text{C}$, $Z_s=Z_l=50\ \text{ohm}$, with application circuit

PARAMETERS	SYMBOL	CONDITIONS	MIN	TYP	MAX	UNITS
Operating voltage	V_{DD}		2.3	2.8	3.6	V
Control voltage (High)	$V_{CTL(H)}$		1.3	1.8	3.6	V
Control voltage (Low)	$V_{CTL(L)}$		0.0	0.0	0.5	V
Operating current1	I_{DD1}	RF OFF, $V_{CTL}=1.8\text{V}$	-	6.0	9.5	mA
Operating current2	I_{DD2}	RF OFF, $V_{CTL}=0\text{V}$	-	11.0	25.0	μA
Control current	I_{CTL}	RF OFF, $V_{CTL}=1.8\text{V}$	-	6.0	10.0	μA

■ ELECTRICAL CHARACTERISTICS

RF CHARACTERISTICS1 (High Gain Mode)

Conditions: $V_{DD}=2.8V$, $V_{CTL}=1.8V$, $f_{RF}=170\sim 900MHz$, $T_a=+25^{\circ}C$, $Z_s=Z_l=50ohm$, with application circuit

PARAMETERS	SYMBOL	CONDITIONS	MIN	TYP	MAX	UNITS
Frequency	f_{RF}		170	620	1680	MHz
Small signal gain1	Gain1	Exclude PCB, connector losses*1	11.0	14.0	18.0	dB
Noise figure1	NF1	Exclude PCB & connector losses*2	-	1.5	1.9	dB
Input power 1dB gain compression1	$P_{-1dB(IN)1}$		-5.0	0.0	-	dBm
Input 3rd order intercept point1	IIP3_1	$f1=f_{RF}$, $f2=f_{RF}+100kHz$, $P_{IN}=-26dBm$	-3.0	+2.0	-	dBm
Isolation1	ISL1	Exclude PCB & connector losses*1	-	-19	-	dB
RF IN VSWR1	VSWRi1		-	1.5	2.3	-
RF OUT VSWR1	VSWRo1		-	1.5	2.2	-

■ ELECTRICAL CHARACTERISTICS

RF CHARACTERISTICS2 (Low Gain Mode)

Conditions: $V_{DD}=2.8V$, $V_{CTL}=0V$, $f_{RF}=170\sim 900MHz$, $T_a=+25^{\circ}C$, $Z_s=Z_l=50ohm$, with application circuit

PARAMETERS	SYMBOL	CONDITIONS	MIN	TYP	MAX	UNITS
Frequency	f_{RF}		170	620	1680	MHz
Small signal gain2	Gain2	Exclude PCB & connector losses*1	-2.5	-1.0	-	dB
Input power at 1dB gain compression2	$P_{-1dB(IN)2}$		+14.0	+17.0	-	dBm
Input 3rd order intercept point2	IIP3_2	$f1=f_{RF}$, $f2=f_{RF}+100kHz$, $P_{IN}=-8dBm$	+17.0	+22.0	-	dBm
RF IN VSWR2	VSWRi2		-	1.5	2.0	-
RF OUT VSWR2	VSWRo2		-	1.5	2.0	-

*1 Input & output PCB and connector losses:

0.035dB(at 170MHz), 0.088dB(620MHz), 0.120dB(at 900MHz), 0.206dB(at 1680MHz)

*2 Input PCB and connector losses:

0.018dB(170MHz), 0.044dB(620MHz), 0.060dB(900MHz), 0.103dB(at 1680MHz)

NJG1142KA1

■ TERMINAL INFORMATION

No.	SYMBOL	DESCRIPTION
1	VCTL	Control voltage supply terminal.
2	GND	Ground terminal. These terminals should be connected to the ground plane as close as possible for excellent RF performance.
3	RFOUT	RF output terminal. This terminal is also the power supply terminal of the LNA. please use inductor (L1) to connect power supply.
4	GND	Ground terminal. These terminals should be connected to the ground plane as close as possible for excellent RF performance.。
5	GND	Ground terminal. These terminals should be connected to the ground plane as close as possible for excellent RF performance.
6	RFIN	RF input terminal. This IC is integrated an input DC blocking capacitor.

■ ELECTRICAL CHARACTERISTICS (High Gain Mode)

(Condition : $T_a=+25^\circ\text{C}$, $V_{DD}=2.8\text{V}$, $V_{CTL}=1.8\text{V}$, $Z_s=Z_l=50\text{ohm}$, with application circuit)

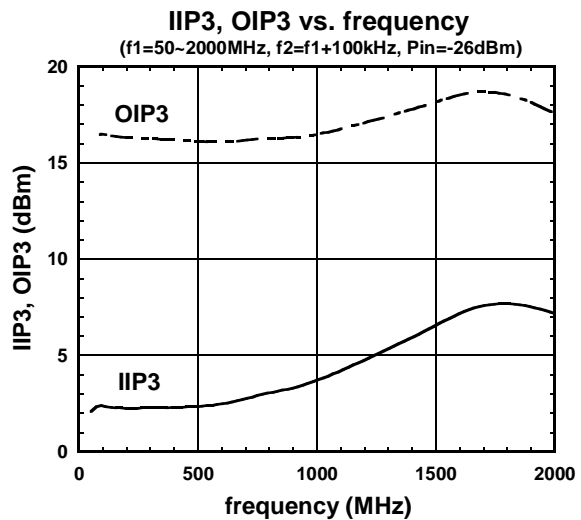
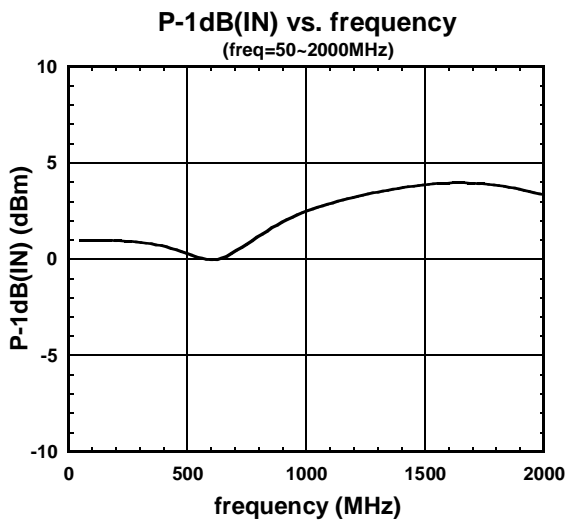
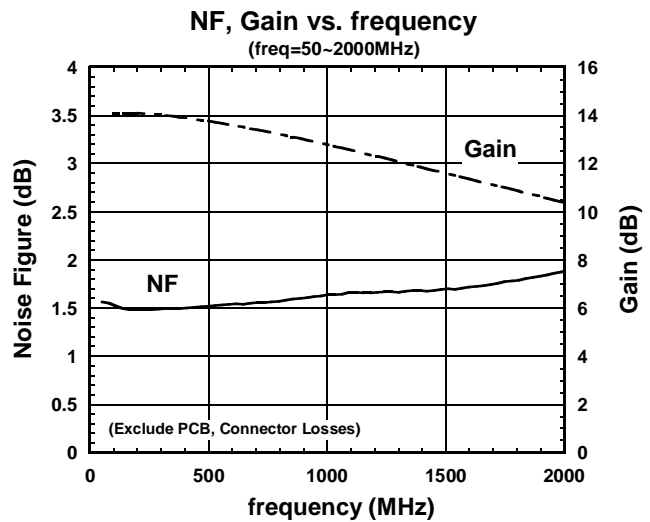
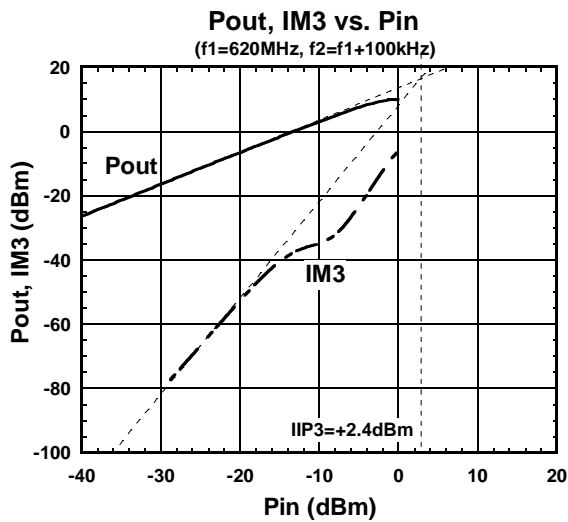
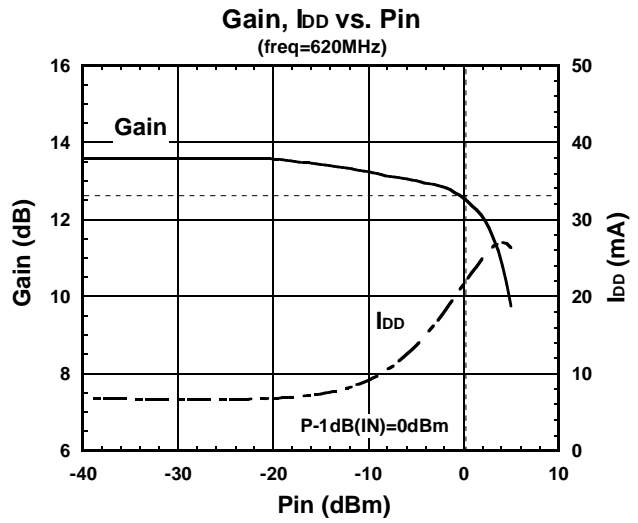
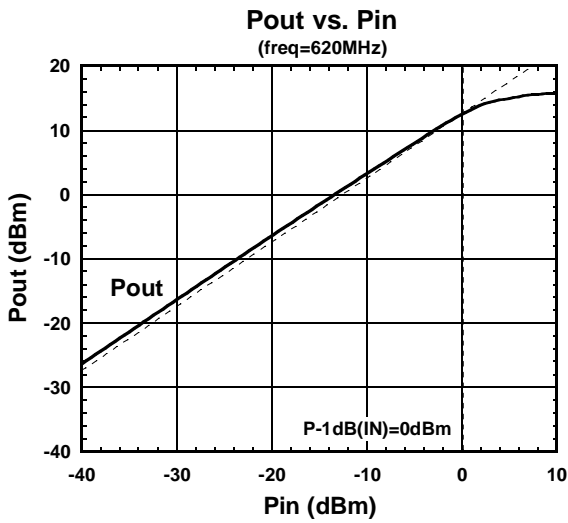

NJG1142KA1

■ ELECTRICAL CHARACTERISTICS(High Gain Mode)

(Condition : $T_a=+25^{\circ}\text{C}$, $V_{CTL}=1.8\text{V}$, $Z_s=Z_l=50\text{ohm}$, with application circuit)

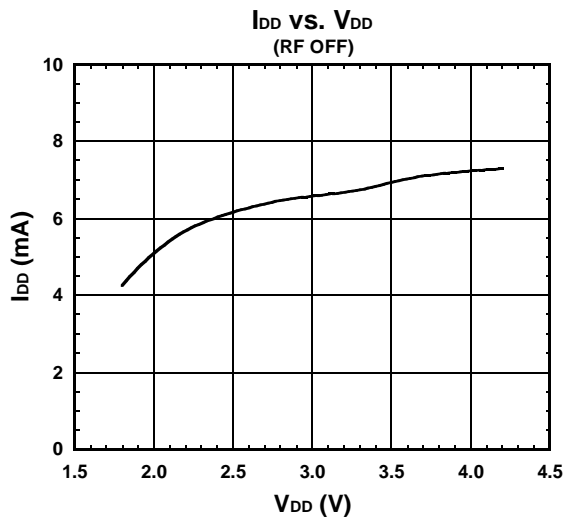
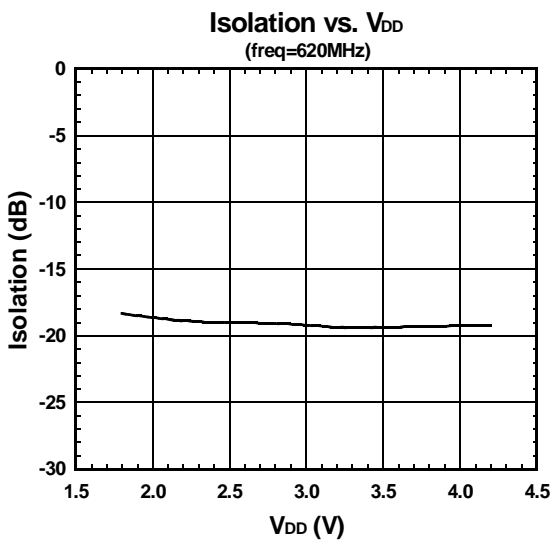
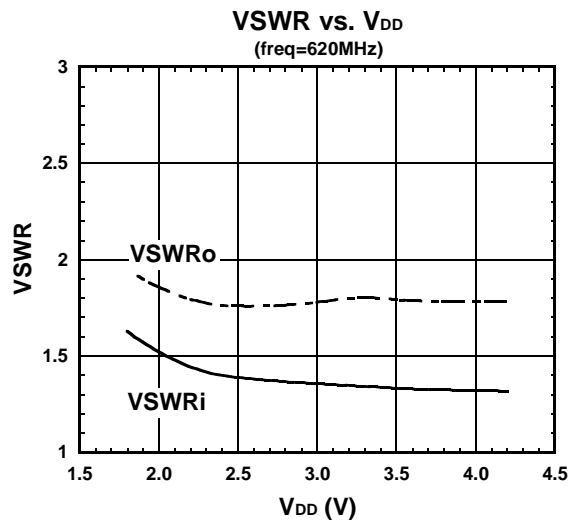
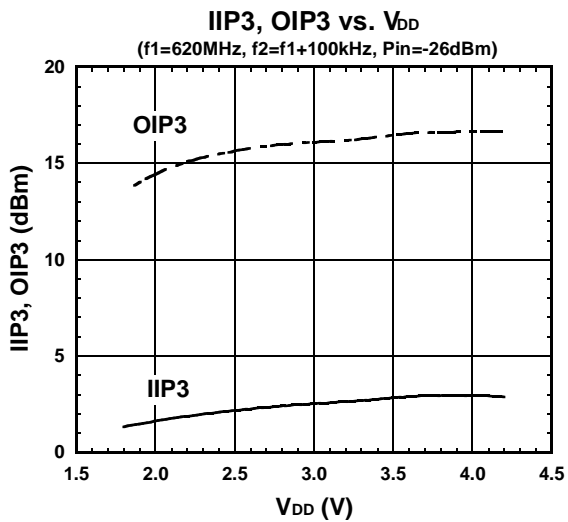
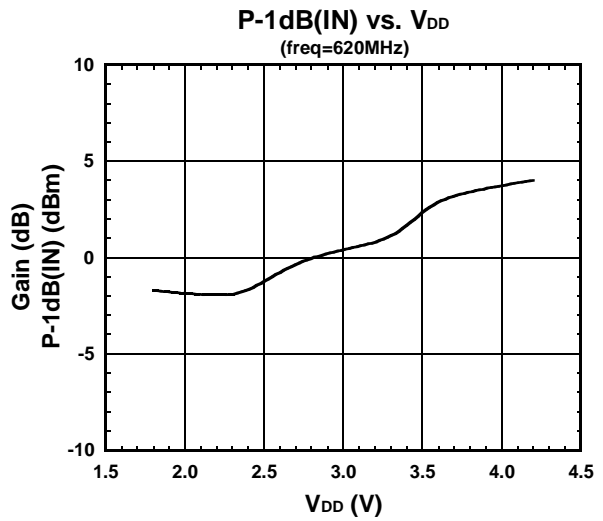
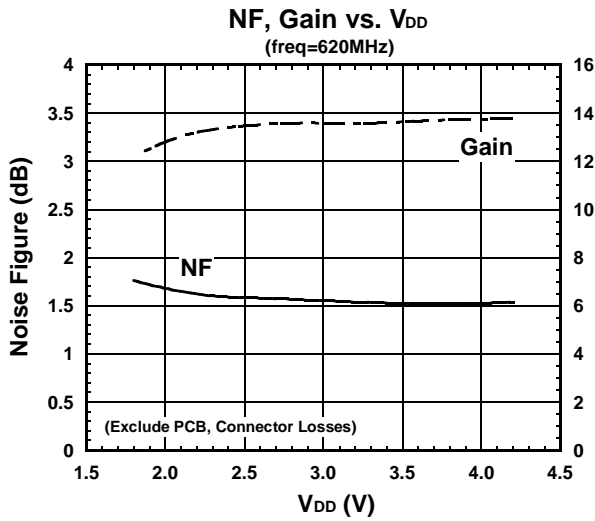

■ ELECTRICAL CHARACTERISTICS (High Gain Mode)

(Condition : $V_{DD}=2.8V$, $V_{CTL}=1.8V$, $Z_s=Z_l=50\Omega$, with application circuit)

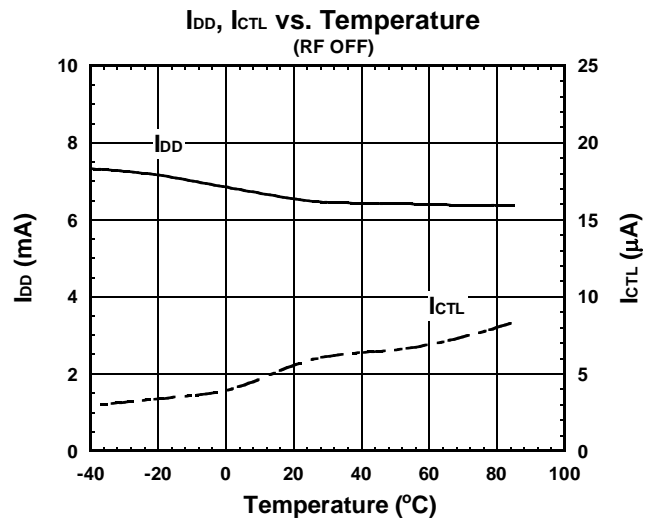
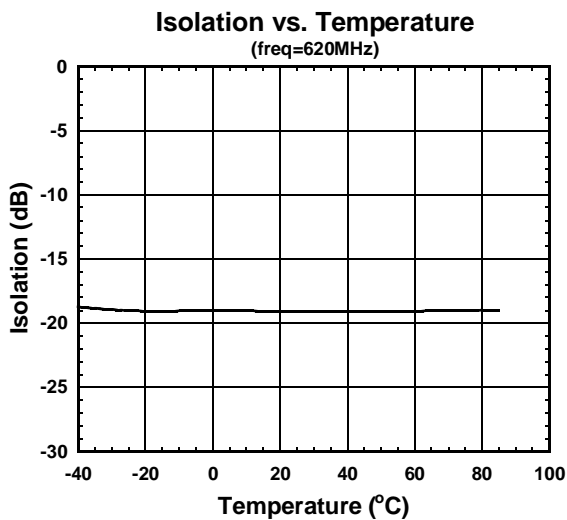
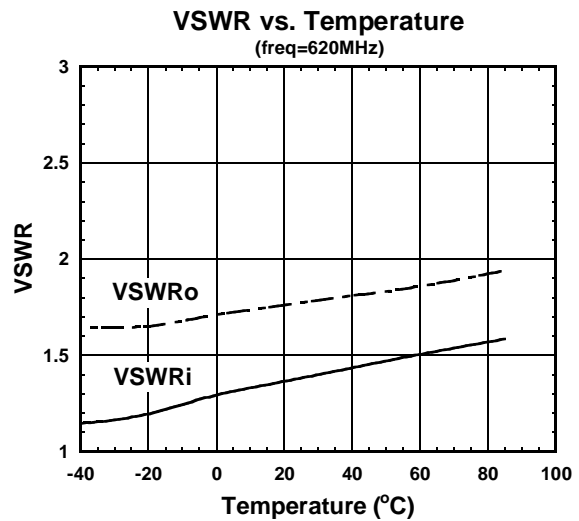
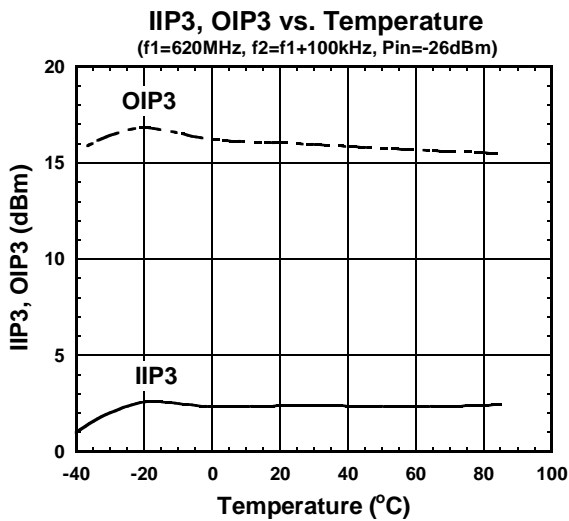
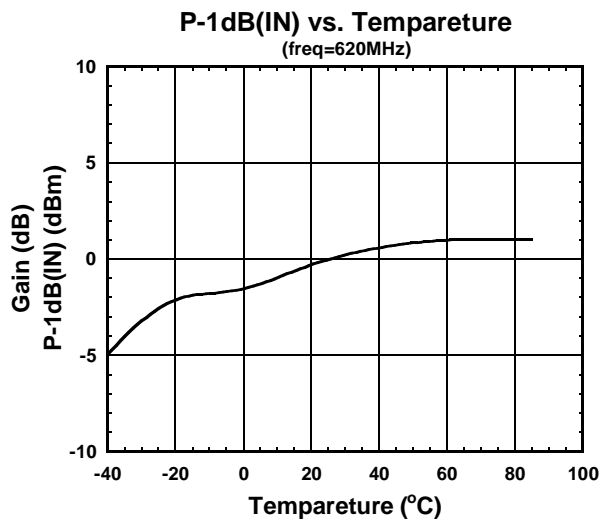
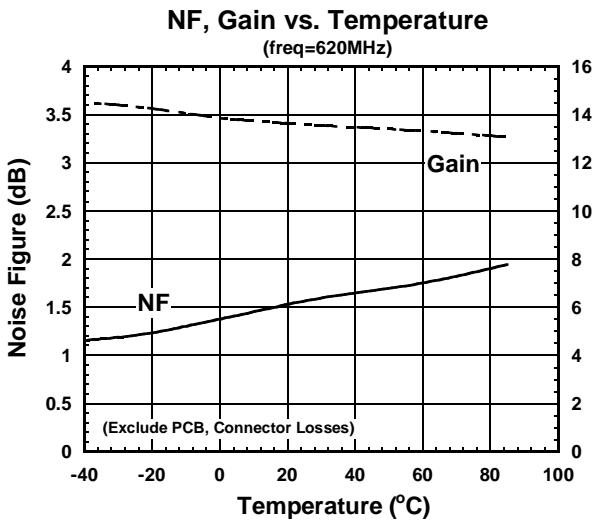

NJG1142KA1

ELECTRICAL CHARACTERISTICS(High Gain Mode)

(Condition : Ta=+25°C, V_{DD}=2.8V, V_{CTL}=1.8V, Z_s=Z_l=50ohm, with application circuit)

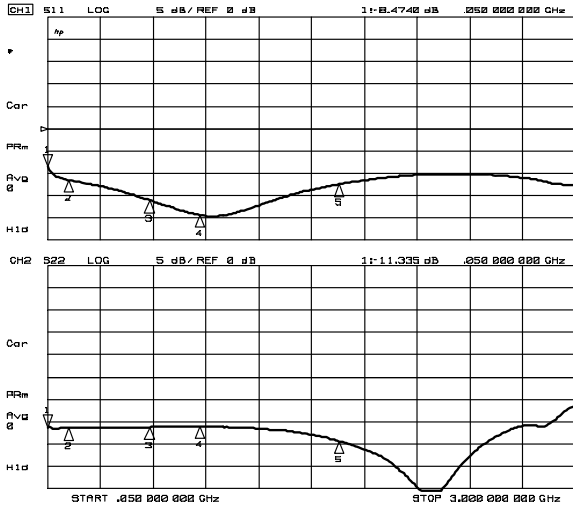

S11, S22

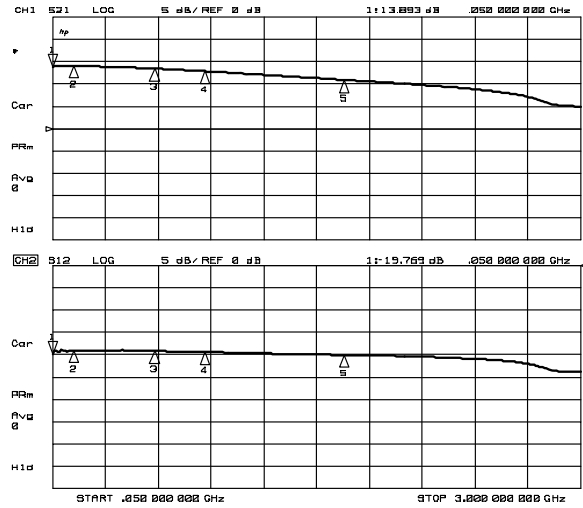

S21, S12

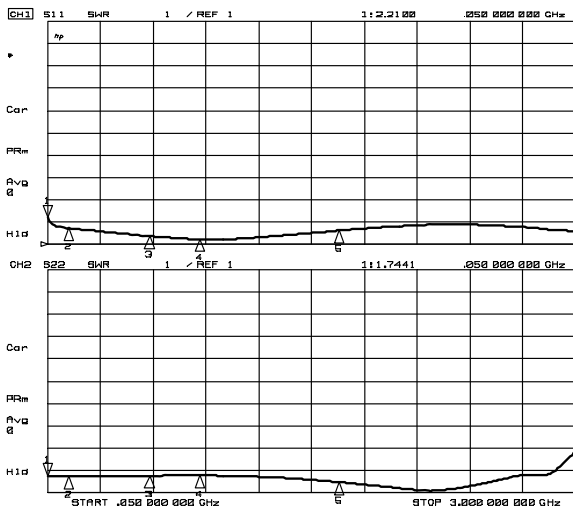

VSWRi, VSWRo

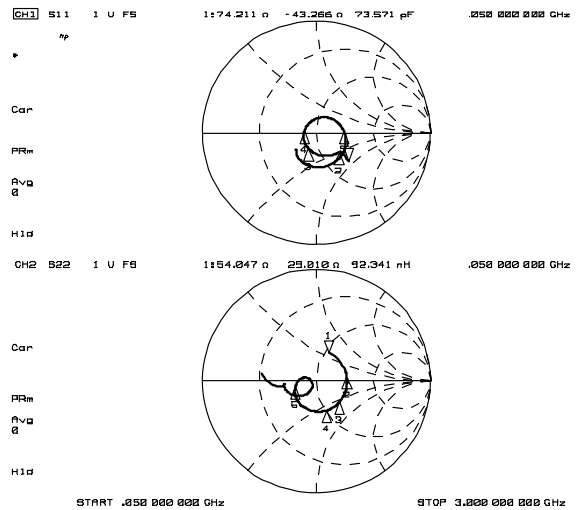

Zin, Zout

■ ELECTRICAL CHARACTERISTICS (High Gain Mode)

(Condition : $T_a=+25^{\circ}\text{C}$, $V_{DD}=2.8\text{V}$, $V_{CTL}=1.8\text{V}$, $Z_s=Z_l=50\text{ohm}$, with application circuit)

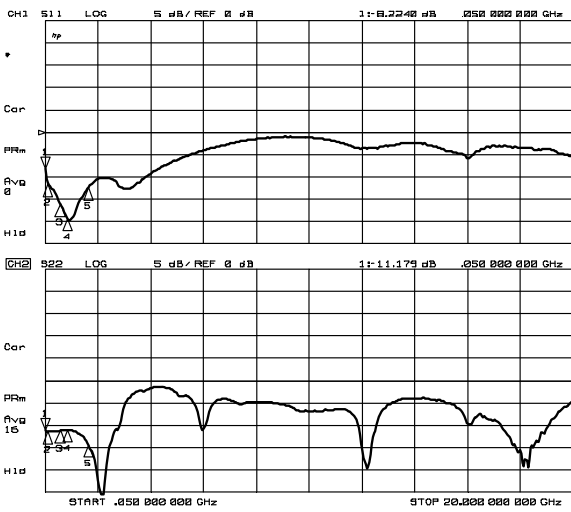

S11, S22 (50MHz~20GHz)

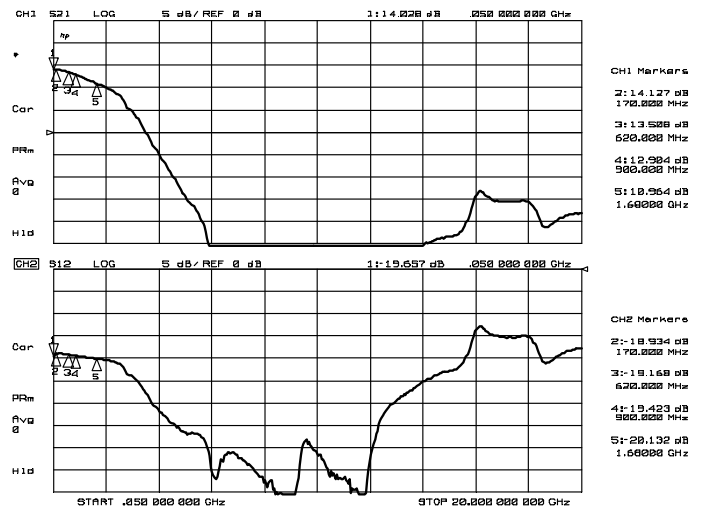

S21, S12 (50MHz~20GHz)

K factor vs. frequency (freq=50MHz~20GHz)

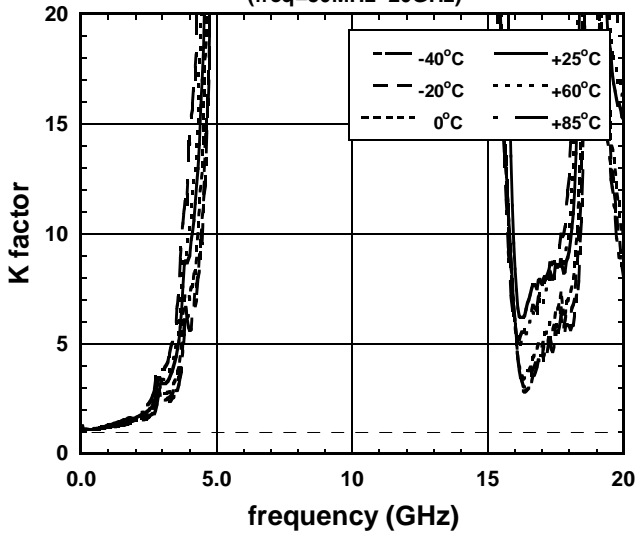

NJG1142KA1

■ ELECTRICAL CHARACTERISTICS (Low Gain Mode)

(Condition : $T_a=+25^{\circ}\text{C}$, $V_{DD}=2.8\text{V}$, $V_{CTL}=0\text{V}$, $Z_s=Z_l=50\text{ohm}$, with application circuit)

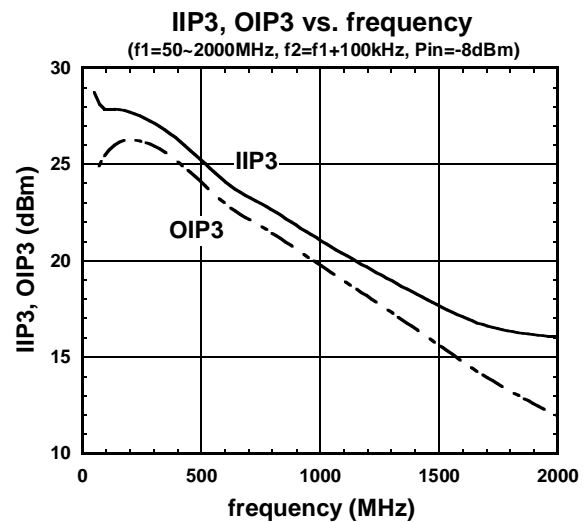
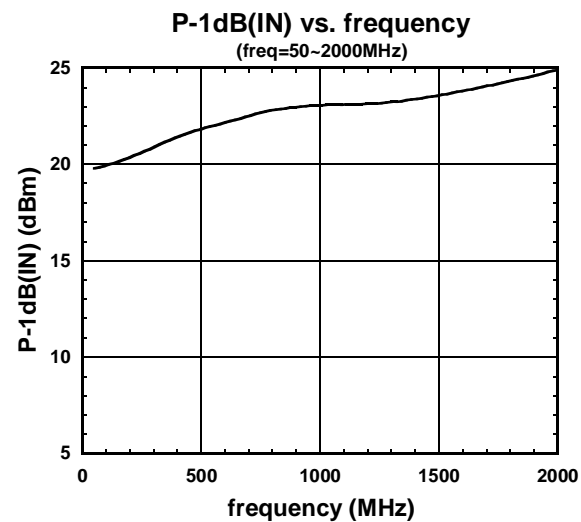
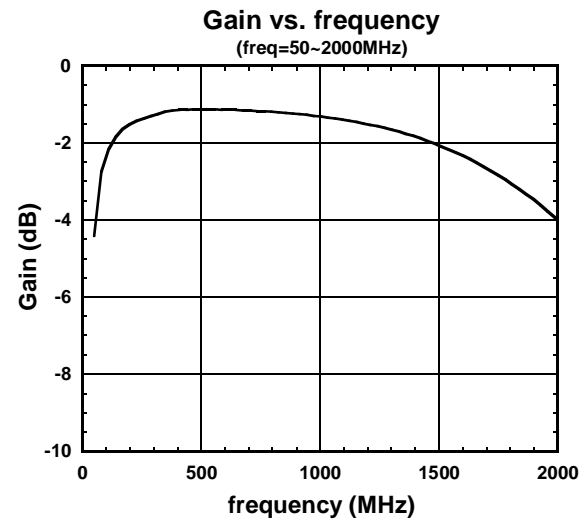
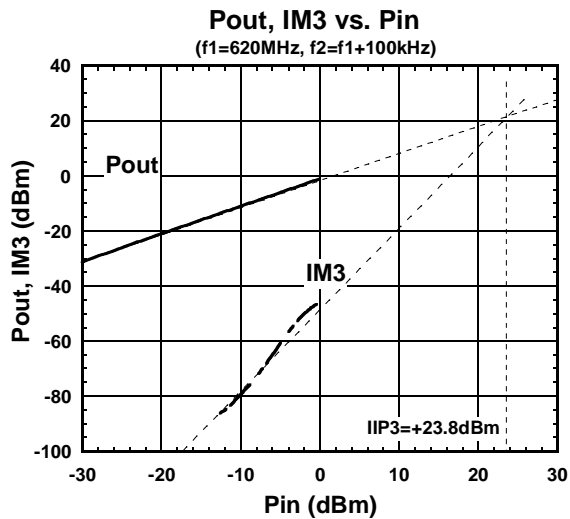
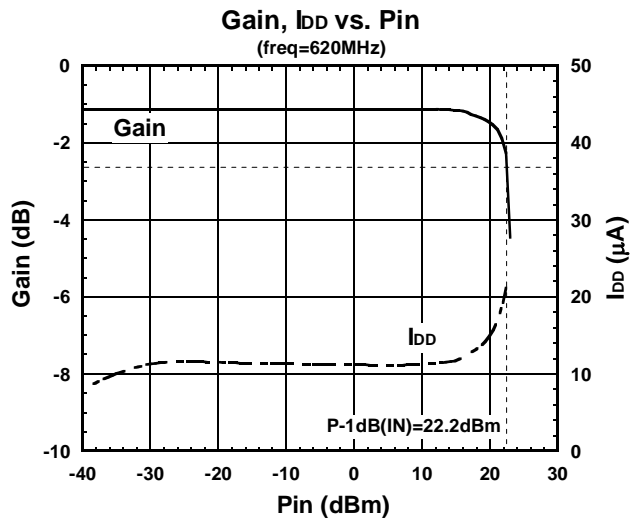
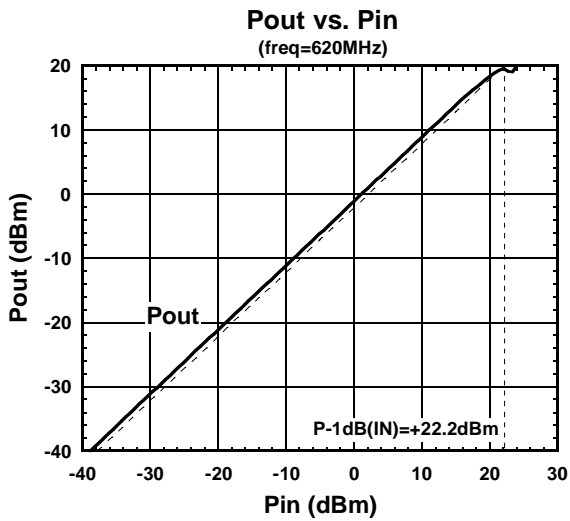

■ ELECTRICAL CHARACTERISTICS (Low Gain Mode)

(Condition : $T_a=+25^\circ\text{C}$, $V_{\text{CTL}}=0\text{V}$, $Z_s=Z_l=50\text{ohm}$, with application circuit)

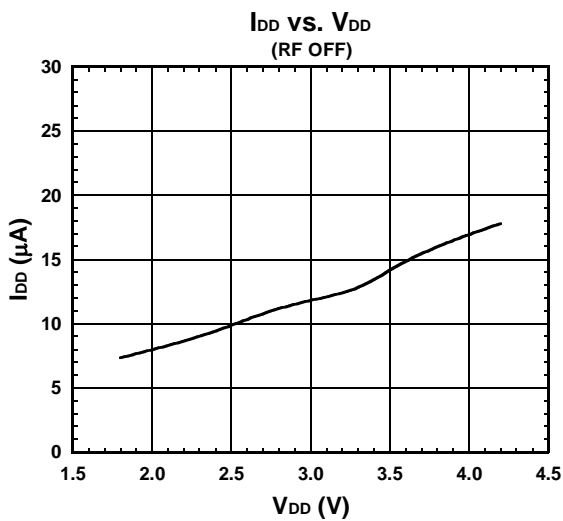
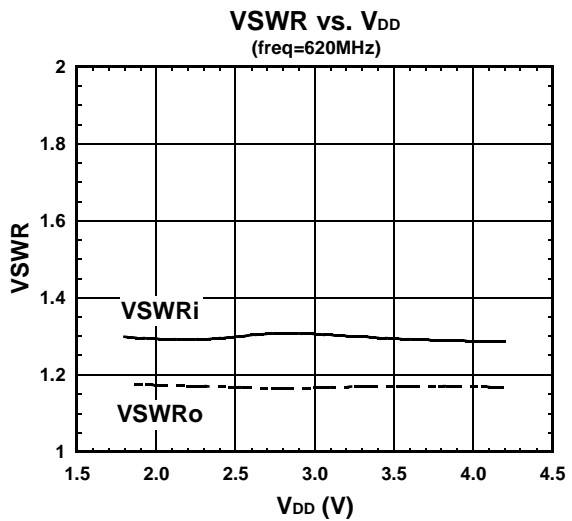
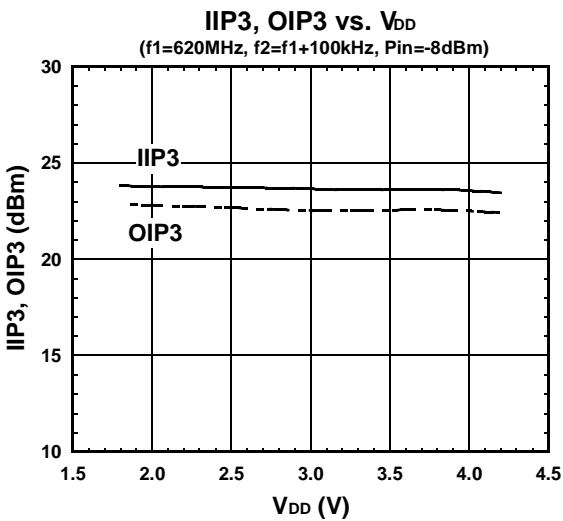
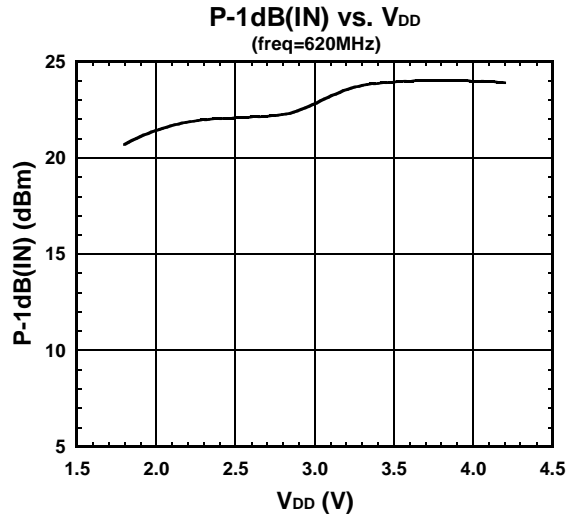
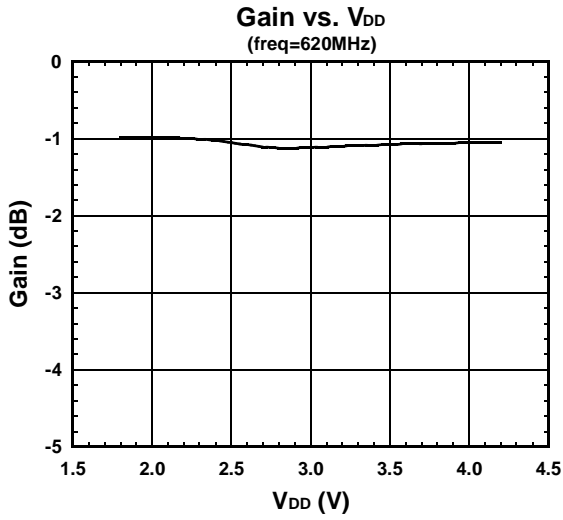

NJG1142KA1

■ ELECTRICAL CHARACTERISTICS (Low Gain Mode)

(Condition : $V_{DD}=2.8V$, $V_{CTL}=0V$, $Z_S=Z_L=50\Omega$, with application circuit)

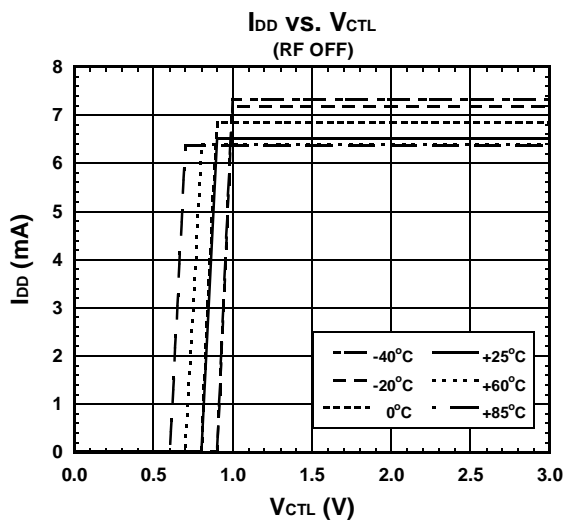
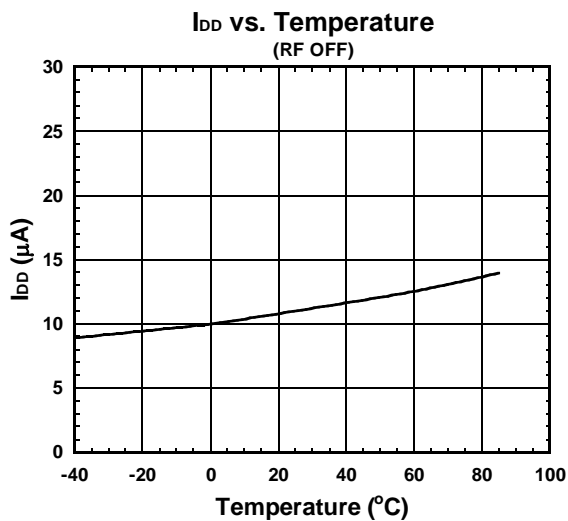
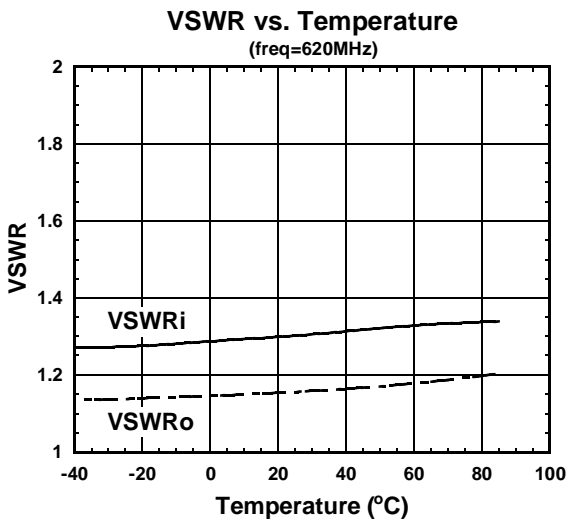
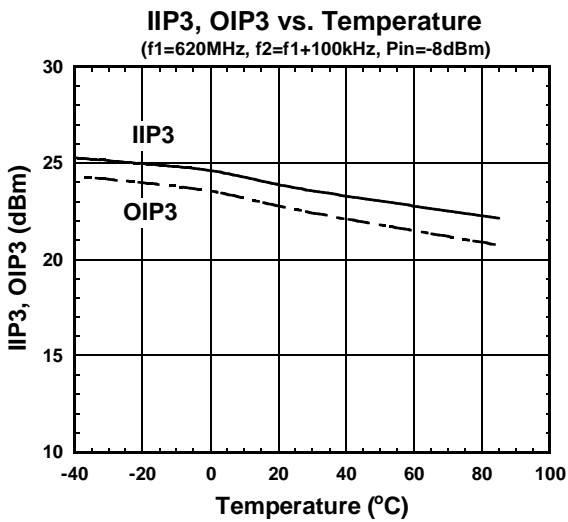
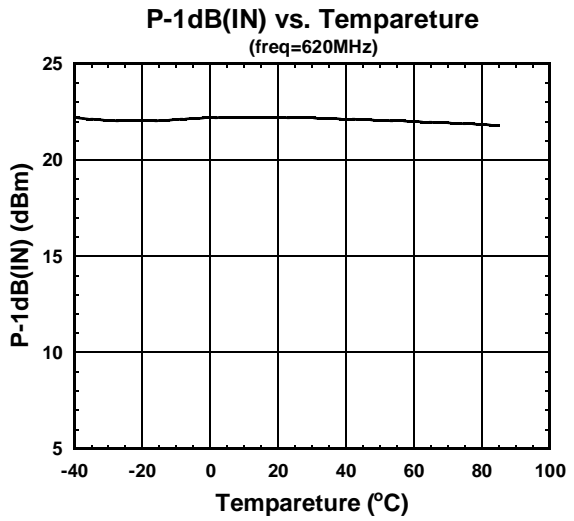
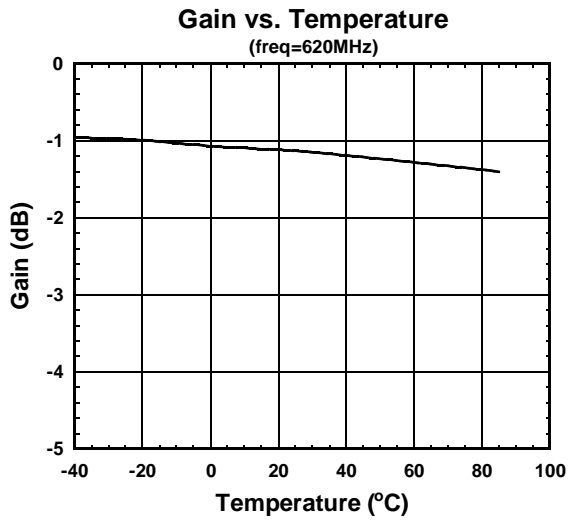

ELECTRICAL CHARACTERISTICS (Low Gain Mode)

(Condition : Ta=+25°C, V_{DD}=2.8V, V_{CTL}=0V, Z_s=Z_l=50ohm,with application circuit)

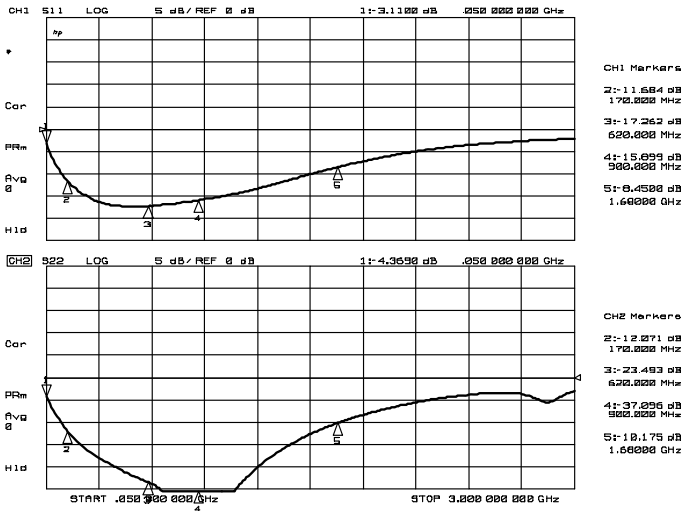

S11, S22

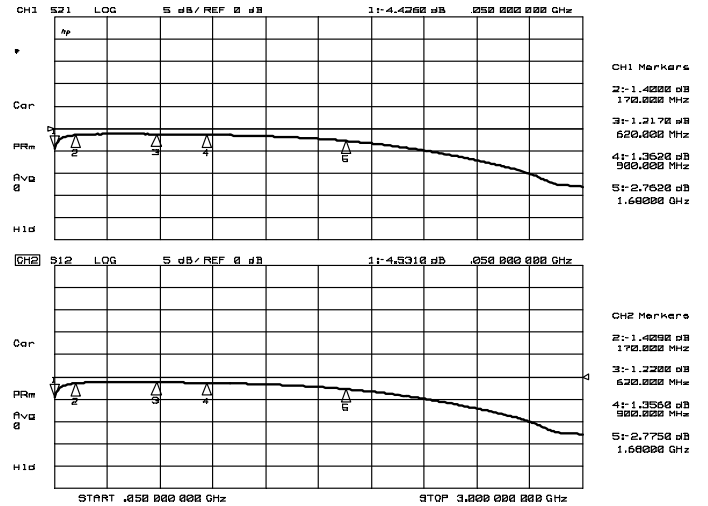

S21, S12

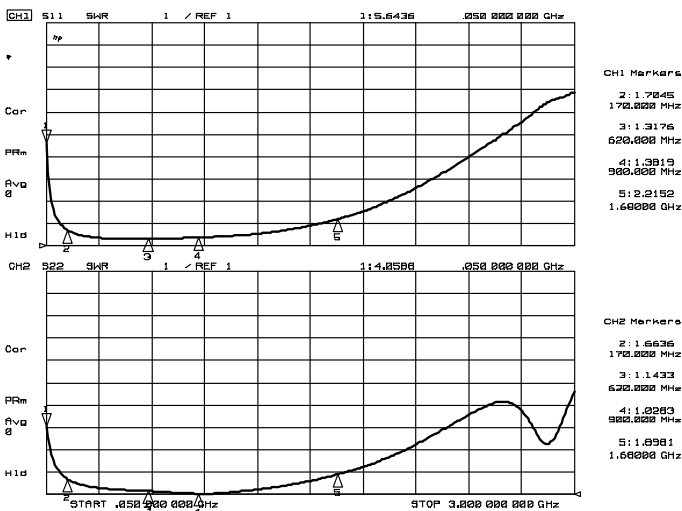

VSWRi, VSWRo

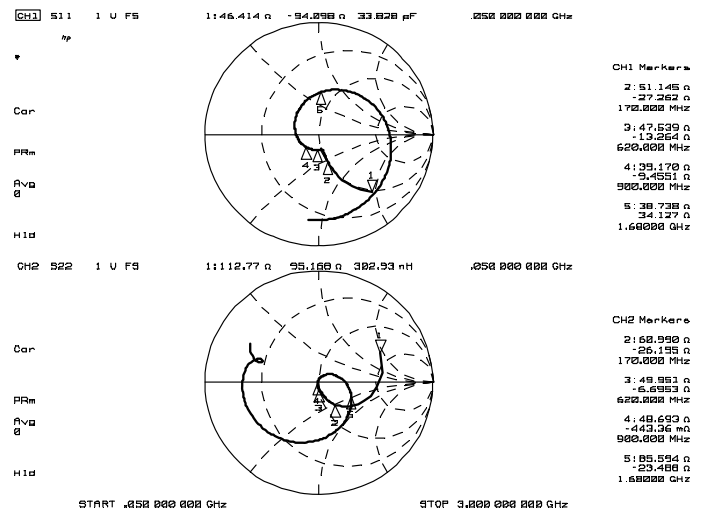

Zin, Zout

NJG1142KA1

ELECTRICAL CHARACTERISTICS (Low Gain Mode)

(Condition : Ta=+25°C, V_{DD}=2.8V, V_{CTL}=0V, Z_s=Z_l=50ohm, With application circuit)

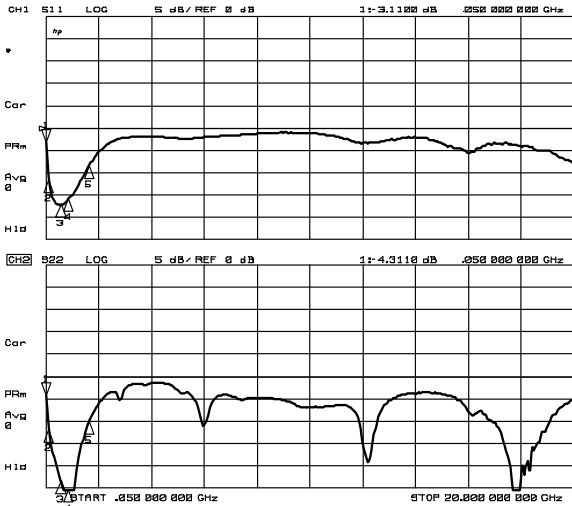

S11, S22 (50MHz~20GHz)

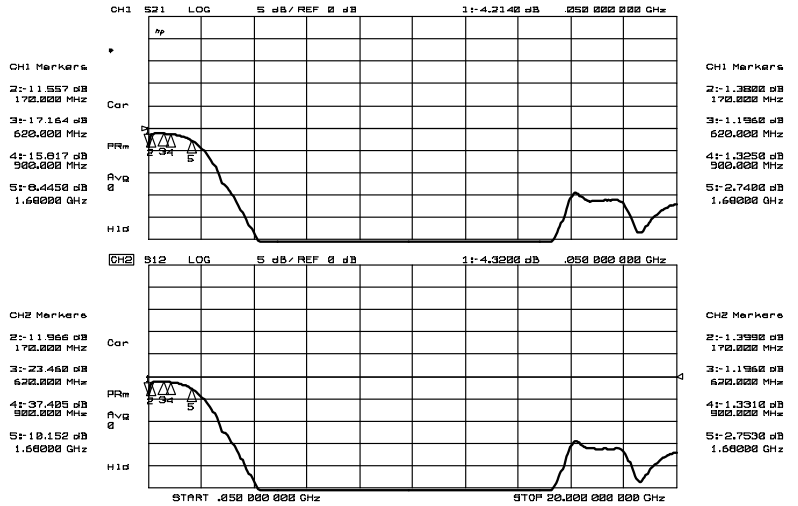

S21, S12 (50MHz~20GHz)

K factor vs. frequency
(freq=50MHz~20GHz)

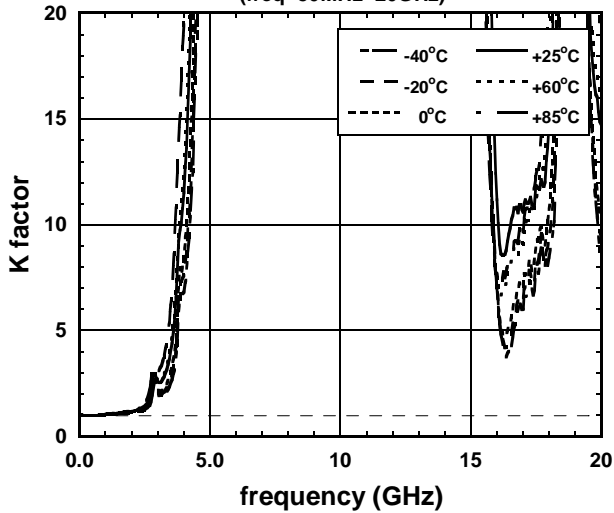

APPLICATION CIRCUIT

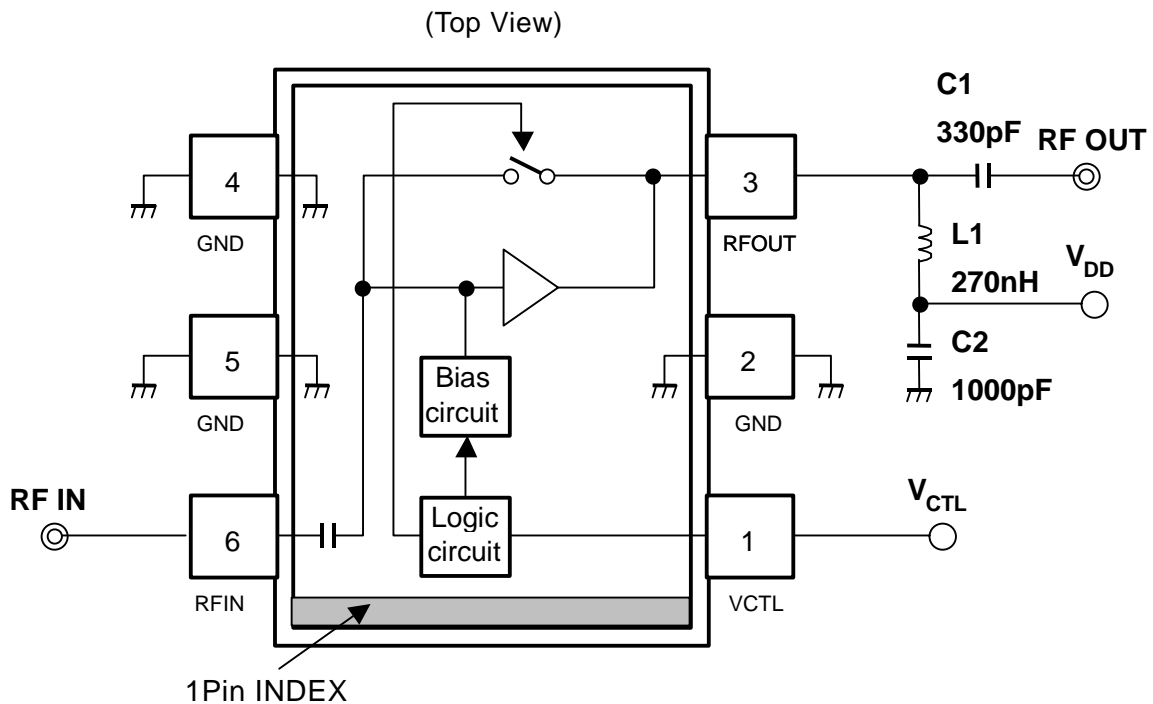

NOTES:

- L1 is an RF choke. (DC feed inductor)
- C1 is a coupling and DC blocking capacitor at the output.
- C2 is a bypass capacitor.

TEST PCB LAYOUT

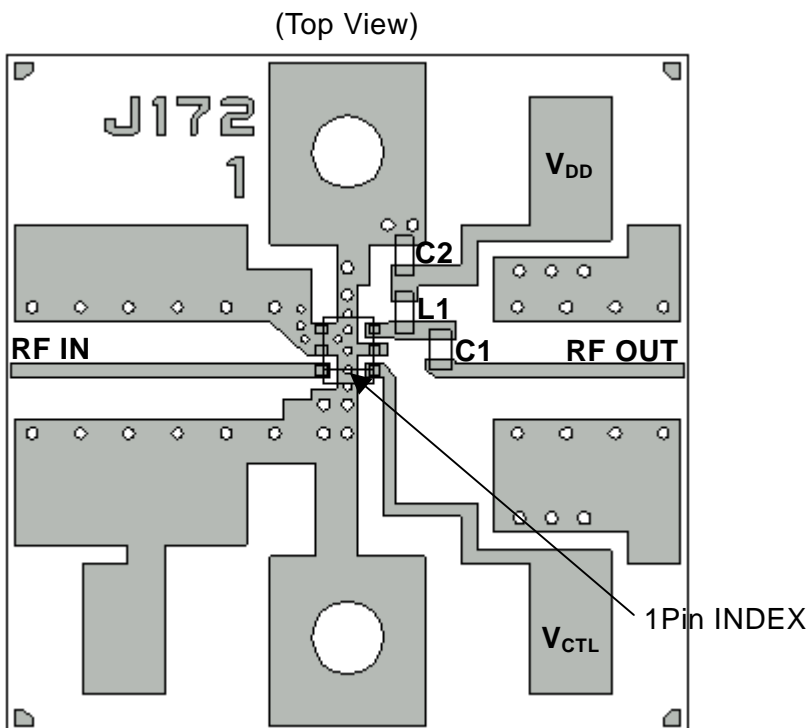

PARTS LIST

Parts ID.	Notes
L1	TAIYO-YUDEN HK1005 Series
C1, C2	MURATA GRM15 Series

PCB (FR-4):

t=0.2mm

MICROSTRIP LINE WIDTH

=0.40mm ($Z_0=50\Omega$)

PCB SIZE=16.8mm x 16.8mm

PRECAUTION:

- In order not to couple with terminal RFIN and RFOUT, please layout ground pattern under the IC.

MEASUREMENT BLOCK DIAGRAM

S parameter Measurements

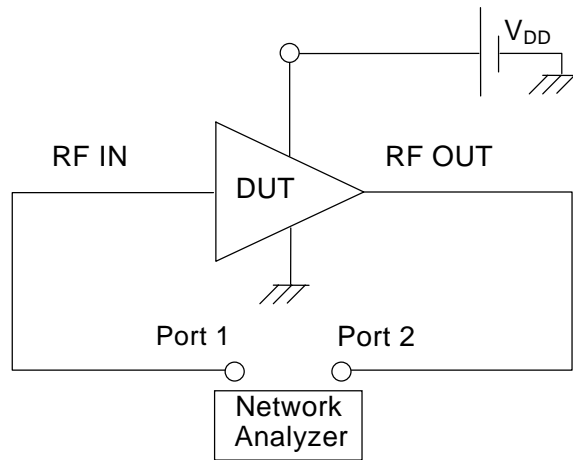

S parameter Measurement Block Diagram

IIP3 Measurements

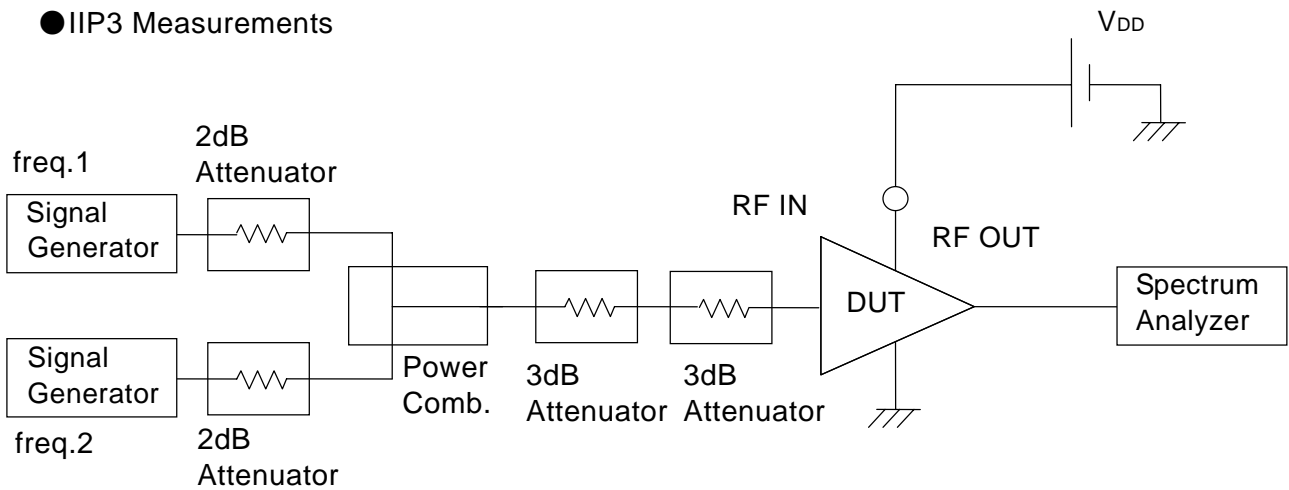

IF and IM3 Measurement Block Diagram for IIP3 (High Gain Mode)

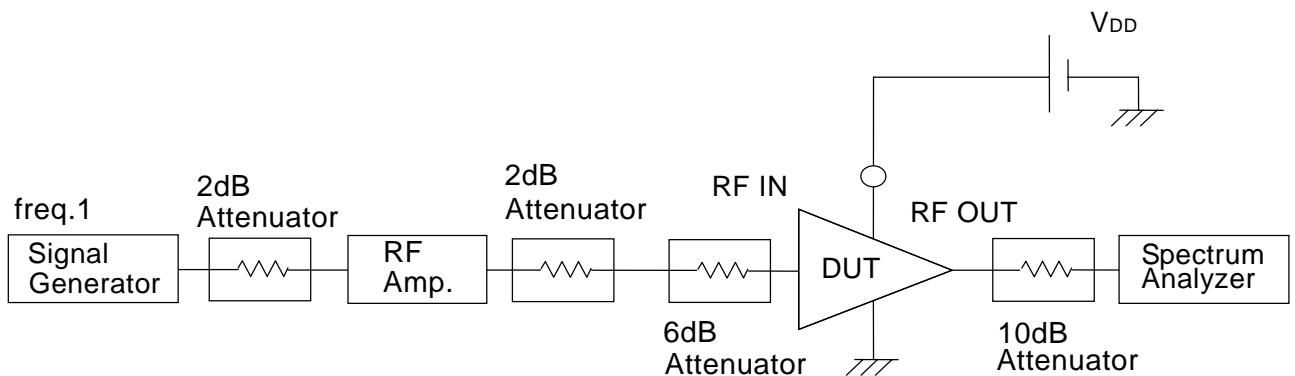

IF and IM3 Measurement Block Diagram for IIP3 (Low Gain Mode)

- Noise Figure Measurements

Measuring instruments

NF Analyzer : Agilent 8973A
 Noise Source : Agilent 346A

Setting the NF analyzer

Measurement mode form

Device under test : Amplifier
 System downconverter : off

Mode setup form

Sideband : LSB
 Averages : 8
 Average mode : Point
 Bandwidth : 4MHz
 Loss comp : off
 Tcold : setting the temperature of noise source (300.0K)

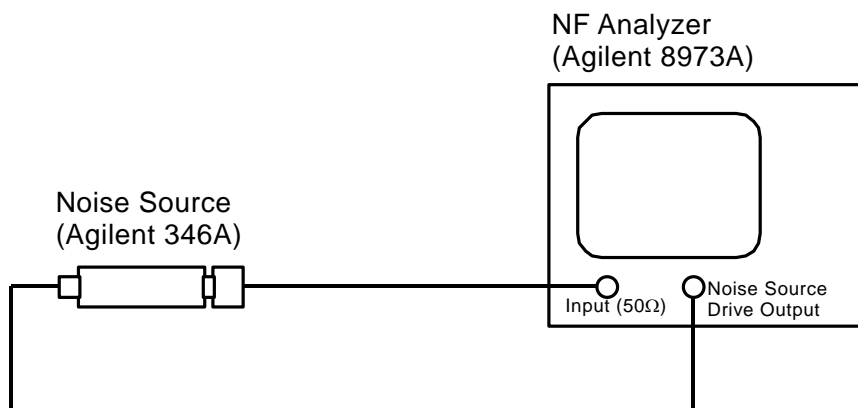

* Noise source and NF analyzer are connected directly.

Calibration Setup

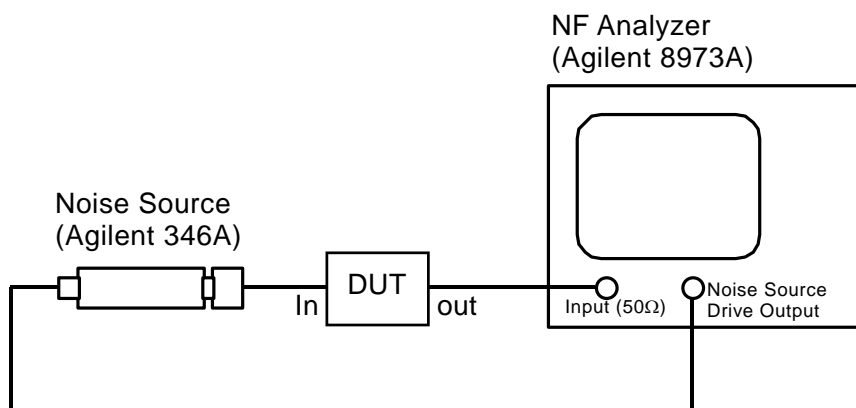

* Noise source and DUT, DUT and NF analyzer are connected directly.

Measurement Setup

NJG1142KA1

■ PACKAGE OUTLINE (FLP6-A1)

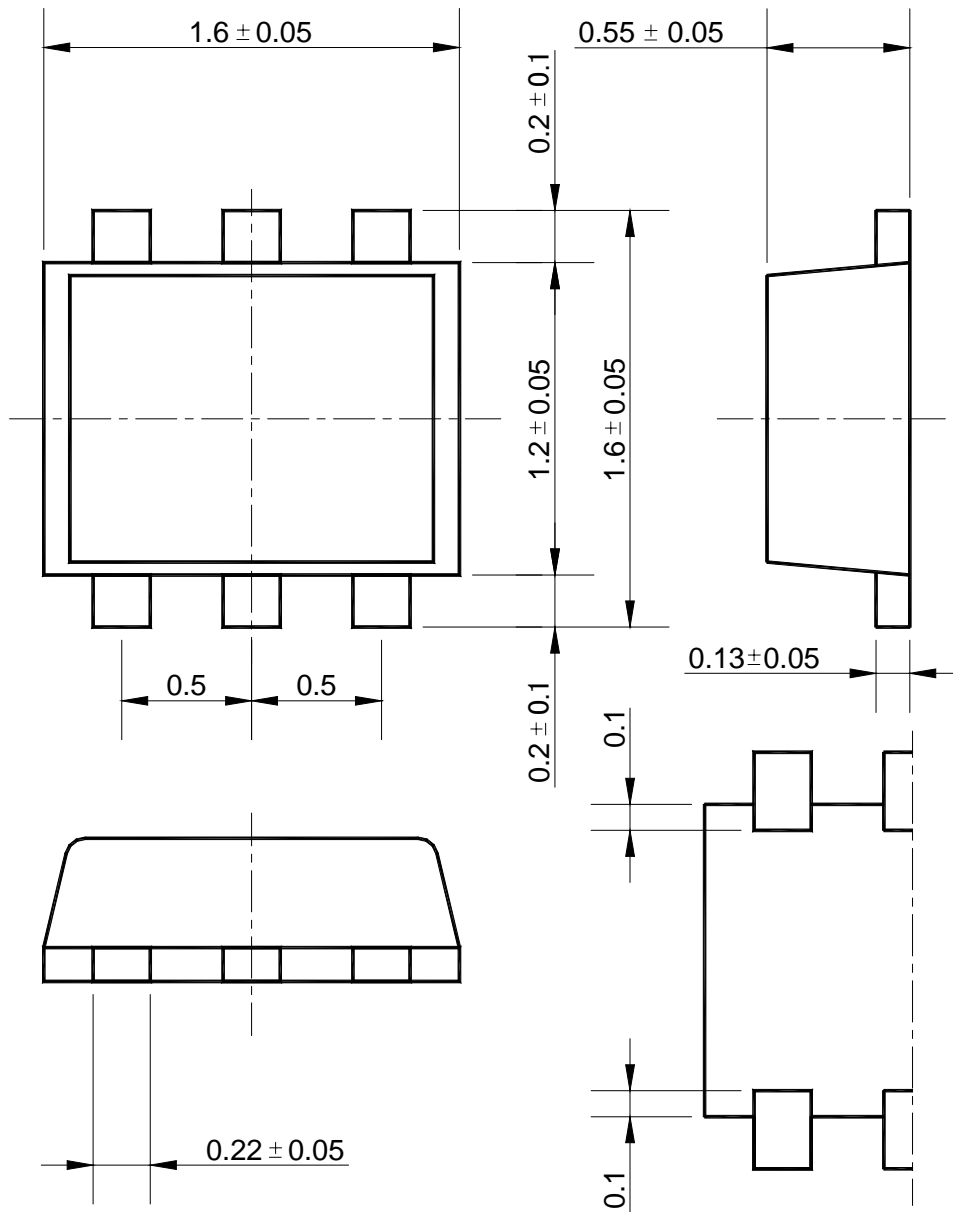

Unit: mm

Cautions on using this product

This product contains Gallium-Arsenide (GaAs) which is a harmful material.

- Do NOT eat or put into mouth.
- Do NOT dispose in fire or break up this product.
- Do NOT chemically make gas or powder with this product.
- To waste this product, please obey the relating law of your country.

[CAUTION]

The specifications on this databook are only given for information, without any guarantee as regards either mistakes or omissions. The application circuits in this databook are described only to show representative usages of the product and not intended for the guarantee or permission of any right including the industrial rights.

This product may be damaged with electric static discharge (ESD) or spike voltage. Please handle with care to avoid these damages.