

# Series 79 Micro-Crimp

## Section F: Straight Printed Circuit Board Connectors

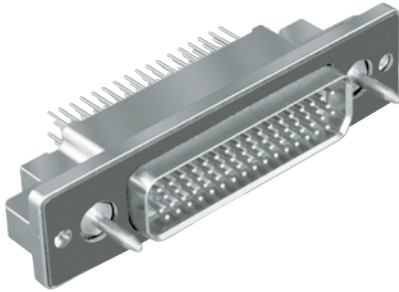

### PANEL RECEPTACLES WITH PIN CONTACTS, STRAIGHT PCB TERMINATION, 790-028P



790-028P connectors are designed for rear-panel mounting and are supplied with conductive panel gaskets. These connectors feature machined aluminum shells, fluorosilicone face seals and straight printed circuit board contacts. Contacts are epoxy-encapsulated and are non-removable. Contacts are gold plated. Connector shells provide blind threaded holes for attaching to panel and to printed circuit board. Available in 29 different insert arrangements, these connectors feature size #23 contacts for signal and data. For higher current applications, size #16 contacts provide up to 13 amps and size #12 contacts handle up to 23 amps.

#### HOW TO ORDER

Sample Part Number

790-028P	J-25P2	M	P	A
Part Number	Shell Size - Insert Arr.	Shell Finish	Hardware Option	PC Tail Length
<p><b>790-028P</b> Rear Panel Mounted Receptacle with PC Tail Pin Contacts for Termination to Backplanes or Flexible Circuits</p>	<p>See Table 1 for Available Insert Arrangements</p>	<p><b>M</b> Electroless Nickel <i>general purpose applications</i></p> <p><b>MT</b> Nickel-PTFE 1000 Hour Grey™ <i>maximum corrosion protection and durability (non-reflective grey)</i></p> <p><b>ZNU</b> Zinc-Nickel with Black Chromate <i>tactical applications (non-reflective black)</i></p> <p>Additional shell finishes are listed on page C-9.</p>	<p><b>N</b> No Hardware</p> <p><b>G</b> Guide Pin</p> <p><b>P</b> Female Jackpost</p> <p><b>S</b> Female Guide Socket</p>	<p><b>A</b> .125 Inch (3.2 mm.)</p> <p><b>B</b> .250 inch (6.4 mm.)</p>

#### SPECIFICATIONS

Current Rating	#23 5 AMPS, #16 13 A., #12 23 A.
Dielectric Withstanding Voltage	#23 500 VAC RMS, #12 and #16 1800 VAC RMS
Insulation Resistance	5000 megohms minimum
Operating Temperature	-65° C. to +150° C.
Shock	300 g.
Vibration	37 g.

#### MATERIALS AND FINISHES

Shell	Aluminum alloy
Contacts	Copper alloy, 50 microinches gold plated
Insulators	Liquid crystal polymer (LCP)
Retention Clips	Beryllium copper alloy
Interfacial Seal	Flourosilicone rubber
Hardware	300 series stainless steel
Panel Gasket	Fluorosilicone, conductive
Encapsulant	Epoxy

Dimensions in inches (millimeters) and are subject to change without notice.

Table 1 Contact Arrangements

Layout	Contact Quantity			Face View
	#23	#16	#12	
A-5	5			
B-2P2	2			
B-9	9			
C-13	13			
D-15	15			
D-3P3	3			
D-7P2	5	2		
E-11P2	9	2		
E-19	19			
E-7P3	4	3		
F-15P2	13	2		
F-23	23			
F-5P5	5			
G-33	33			
H-10P4	6	4		
H-29P7	22	7		
H-36P2	34	2		
H-54P2	52	2		
H-5P5		5		
H-66	66			
J-17P4	13	4		
J-25P2	23	2		
J-33	33			
J-7P7	7			
K-27P4	23	4		
K-35P2	33	2		
K-43	43			
K-9P9	9			
L-6P6		6		

CROSS-SECTIONAL VIEW OF 790-028P

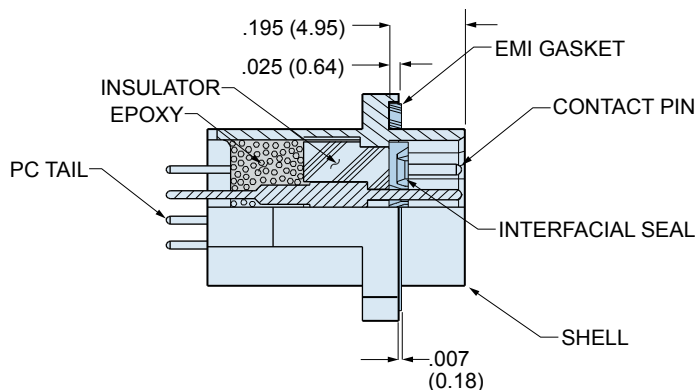
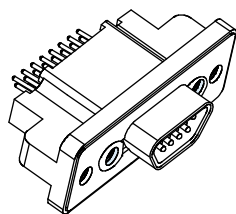

TABLE 2 HARDWARE OPTION



**N**

**No Mating Hardware**

Connector is supplied with threaded holes. Shell sizes H and L have #6-32 threads, other sizes have #4-40 threads. Thread depth is .150" (3.8).

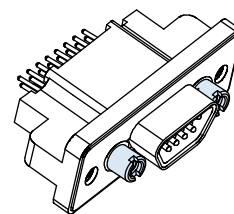

**P**

**Jackposts**

Connector is supplied with non-removable stainless steel jackposts. Shell sizes H and L have #4-40 UNC thread, other sizes have #2-56 thread.

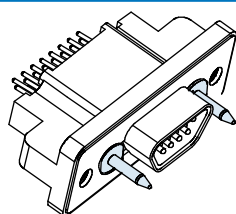

**G**

**Guide Pins**

Connector is supplied with stainless steel non-removable guide pins. Mates with type "S" guide sockets on corresponding plug connector.

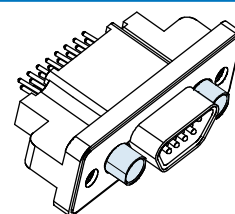

**S**

**Guide Sockets**

Connector is supplied with stainless steel non-removable bushings. Mates with type "G" guide pins on corresponding plug connector.

Dimensions in inches (millimeters) and are subject to change without notice.

CAGE Code 06324

Printed in U.S.A.

© 2009 Glenair, Inc.

GLENAIR, INC. • 1211 AIR WAY • GLENDALE, CA 91201-2497 • 818-247-6000 • FAX 818-500-9912

www.glenair.com

F-2

E-Mail: sales@glenair.com

Rev. 04-July-2009

# Series 79 Micro-Crimp Section F: Straight Printed Circuit Board Connectors



## 790-028P SHELL SIZE A,B,C,D,E,F,J,K DIMENSIONS

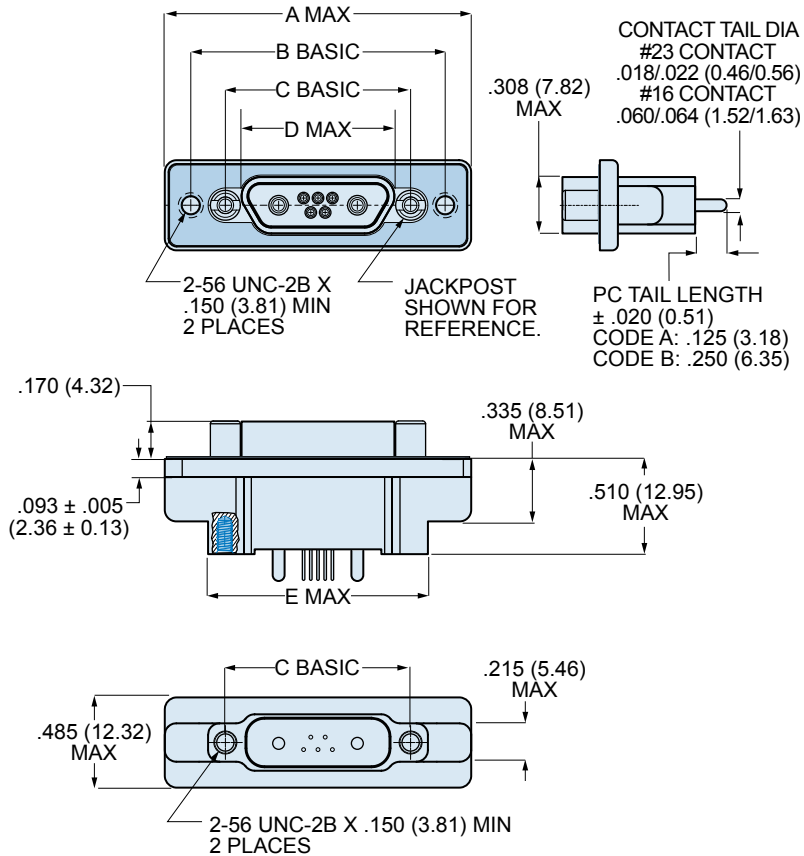

### BLIND MATE

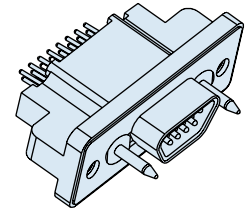

SHELL SIZES A, B, C, D, E, F, G, J, K  
+/- .030 (0.76) ALLOWABLE MISALIGNMENT FROM CENTERLINE

### 790-028P DIMENSIONS FOR SIZE A-F, J AND K

Shell Size	A Max.		B Basic		C Basic		D Max.		E Max.	
	In.	mm.	In.	mm.	In.	mm.	In.	mm.	In.	mm.
A	1.211	30.76	.925	23.50	.565	14.35	.401	10.19	.760	19.30
B	1.361	34.57	1.075	27.31	.715	18.16	.551	14.00	.910	21.11
C	1.511	38.38	1.225	31.12	.865	21.97	.701	17.81	1.060	26.92
D	1.611	40.92	1.325	33.66	.965	24.51	.801	20.35	1.160	29.46
E	1.761	44.73	1.475	37.47	1.115	28.32	.951	24.16	1.310	33.27
F	1.911	48.54	1.625	41.28	1.265	32.13	1.101	27.96	1.460	37.08
J	2.261	57.43	1.975	50.17	1.615	41.02	1.460	37.08	1.810	45.97
K	2.661	67.59	2.375	60.33	2.015	51.18	1.860	47.24	2.210	56.13

Dimensions in inches (millimeters) and are subject to change without notice.

790-028P SHELL SIZE G DIMENSIONS

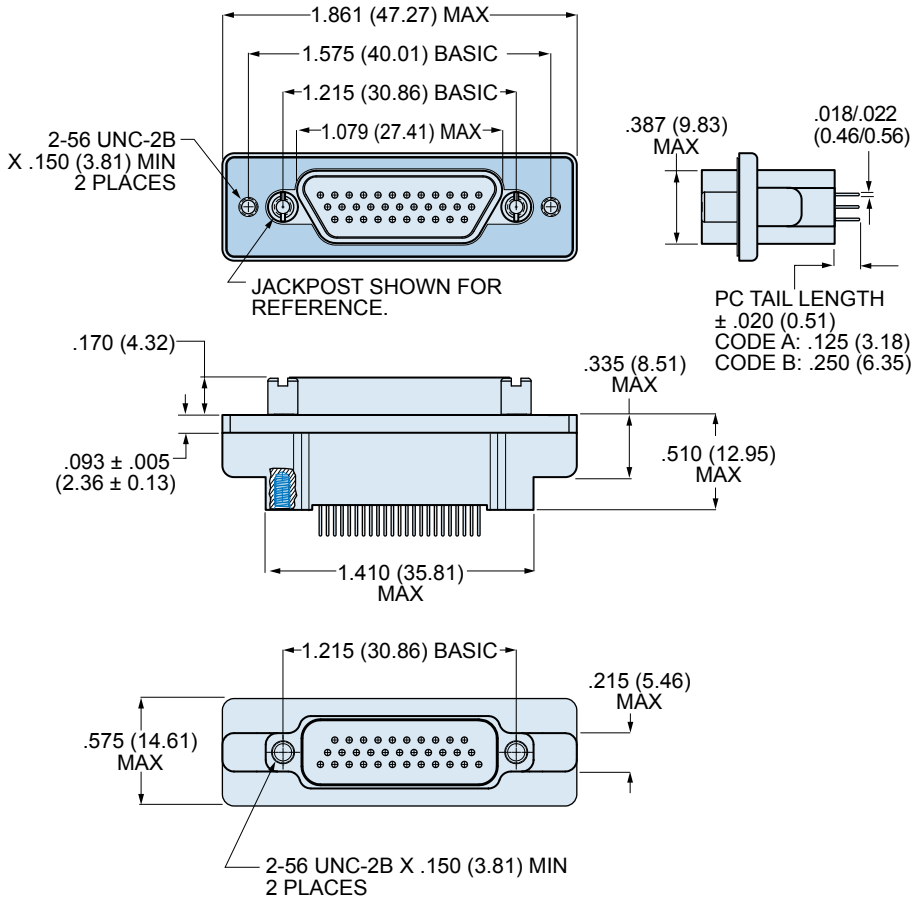

BLIND MATE

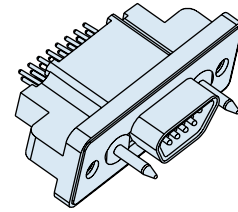

SHELL SIZES A, B, C, D, E, F, G, J, K  
+/- .030 (0.76) ALLOWABLE MISALIGNMENT FROM CENTERLINE

# Series 79 Micro-Crimp Section F: Straight Printed Circuit Board Connectors



## 790-028P SHELL SIZE H, L DIMENSIONS

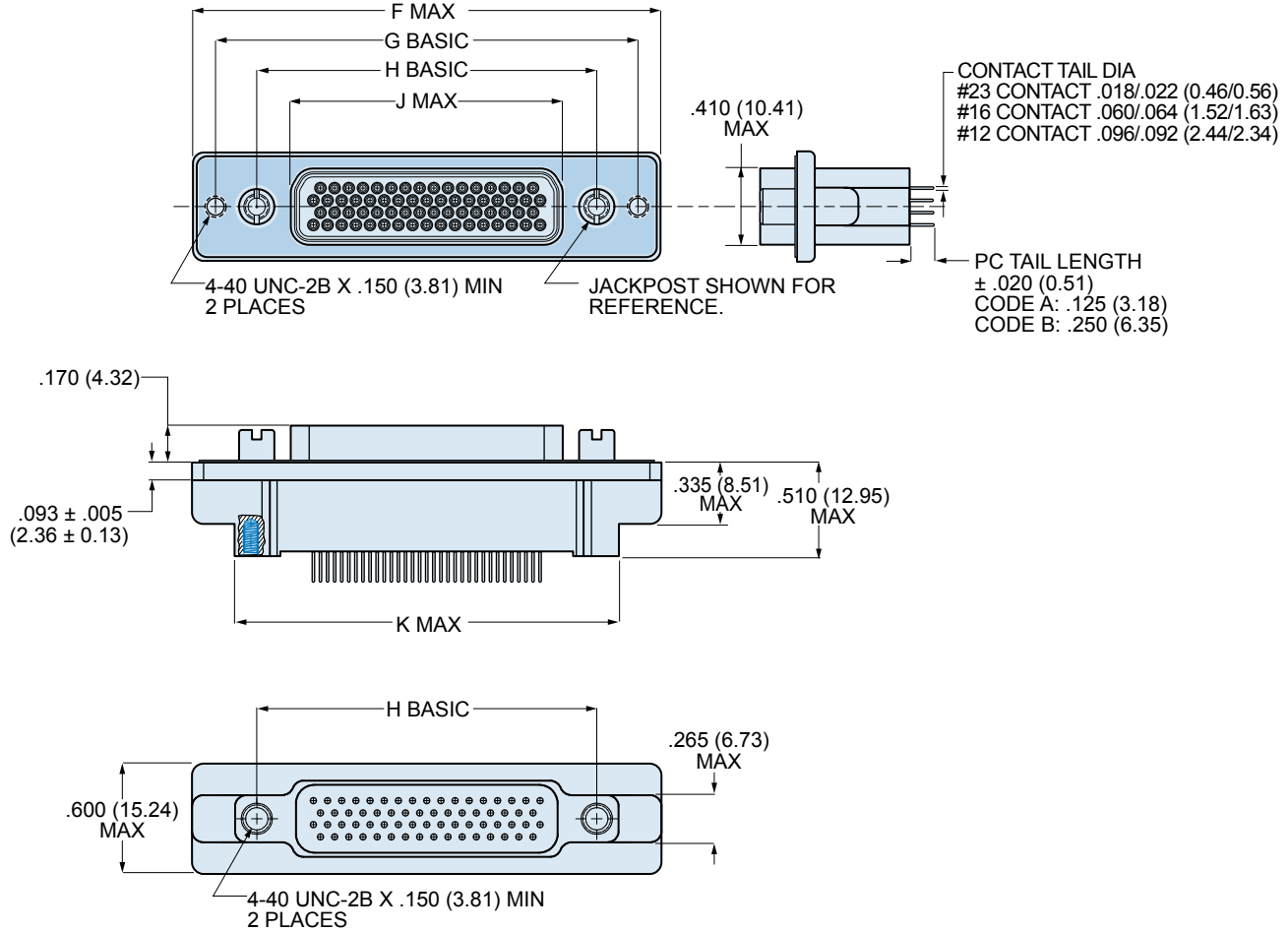

### 790-028P SIZE H & L DIMENSIONS

Shell Size	F Max.		G Basic		H Basic		J Max.		K Max.	
	In.	mm.	In.	mm.	In.	mm.	In.	mm.	In.	mm.
H	2.500	63.50	2.236	56.79	1.800	45.72	1.450	36.83	2.045	51.94
L	2.736	69.49	2.472	62.79	2.036	51.71	1.686	42.82	2.281	57.94

### BLIND MATE

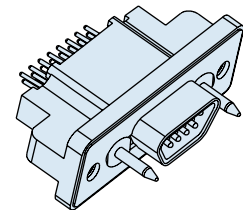

SHELL SIZES H, L  
+/- .040 (1.02) ALLOWABLE MISALIGNMENT FROM CENTERLINE

Dimensions in inches (millimeters) and are subject to change without notice.

PCB Hole Patterns for 790-028P and 790-043P Receptacles

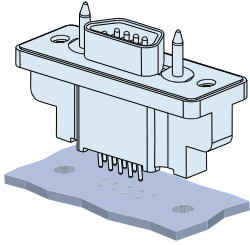

This section contains printed circuit board footprints for vertical mounted Series 79 receptacles. The contact identification numbers are shown for the connector mounting side of the PC board. Contact tails are gold over nickel plated.

Contact Size	PC Tail Diameter	
	In.	mm.
#23	.018-.022	0.46-0.56
#16	.060-.064	1.52-1.63
#12	.092-.096	2.34-2.44

790-028P PRINTED CIRCUIT BOARD PATTERNS

Insert Arr.	Component Mounting Side of PCB
A-5	
B-2P2	
B-9	
C-13	

Dimensions in inches (millimeters) and are subject to change without notice.

# Series 79 Micro-Crimp Section F: Straight Printed Circuit Board Connectors



## 790-028P PRINTED CIRCUIT BOARD PATTERNS

Insert Arr.	Component Mounting Side of PCB
D-15	
D-3P3	
D-7P2	
E-11P2	
E-19	

Dimensions in inches (millimeters) and are subject to change without notice.

790-028P PRINTED CIRCUIT BOARD PATTERNS

Insert Arr.	Component Mounting Side of PCB
E-7P3	
F-15P2	
F-23	
F-5P5	
G-33	

Dimensions in inches (millimeters) and are subject to change without notice.

© 2009 Glenair, Inc.

CAGE Code 06324

Printed in U.S.A.

GLENAIR, INC. • 1211 AIR WAY • GLENDALE, CA 91201-2497 • 818-247-6000 • FAX 818-500-9912

www.glenair.com

F-12

E-Mail: sales@glenair.com

Rev. 04-July-2009



# Series 79 Micro-Crimp Section F: Straight Printed Circuit Board Connectors



## 790-028P PRINTED CIRCUIT BOARD PATTERNS

Insert Arr.	Component Mounting Side of PCB
H-10P4	
H-29P7	
H-36P2	
H-54P2	
H-5P5	

Dimensions in inches (millimeters) and are subject to change without notice.

790-028P PRINTED CIRCUIT BOARD PATTERNS

Insert Arr.	Component Mounting Side of PCB
H-66	
J-17P4	
J-25P2	
J-33	
J-7P7	

Dimensions in inches (millimeters) and are subject to change without notice.

# Series 79 Micro-Crimp Section F: Straight Printed Circuit Board Connectors



## 790-028P PRINTED CIRCUIT BOARD PATTERNS

Insert Arr.	Component Mounting Side of PCB
K-27P4	
K-35P2	
K-43	
K-9P9	
L-6P6	

Dimensions in inches (millimeters) and are subject to change without notice.