

# PBRN113E series

NPN 800 mA, 40 V BISS RETs; R1 = 1 k $\Omega$ , R2 = 1 k $\Omega$

Rev. 01 — 1 March 2007

Product data sheet

## 1. Product profile

### 1.1 General description

800 mA NPN low  $V_{CEsat}$  Breakthrough In Small Signal (BISS) Resistor-Equipped Transistors (RET) family in small plastic packages.

Table 1. Product overview

Type number	Package		
	NXP	JEITA	JEDEC
PBRN113EK	SOT346	SC-59A	TO-236
PBRN113ES <sup>[1]</sup>	SOT54	SC-43A	TO-92
PBRN113ET	SOT23	-	TO-236AB

[1] Also available in SOT54A and SOT54 variant packages (see [Section 2](#)).

### 1.2 Features

- 800 mA output current capability
- High current gain  $h_{FE}$
- Built-in bias resistors
- Simplifies circuit design
- Low collector-emitter saturation voltage  $V_{CEsat}$
- Reduces component count
- Reduces pick and place costs
- $\pm 10\%$  resistor ratio tolerance

### 1.3 Applications

- Digital application in automotive and industrial segments
- Medium current peripheral driver
- Switching loads

### 1.4 Quick reference data

Table 2. Quick reference data

Symbol	Parameter	Conditions	Min	Typ	Max	Unit
$V_{CEO}$	collector-emitter voltage	open base	-	-	40	V
$I_O$	output current			<sup>[1]</sup>		
		PBRN113EK, PBRN113ET	-	-	600	mA
		PBRN113ES	-	-	800	mA

Table 2. Quick reference data ...continued

Symbol	Parameter	Conditions	Min	Typ	Max	Unit
$I_{ORM}$	repetitive peak output current					
	PBRN113EK, PBRN113ET	$t_p \leq 1$ ms; $\delta \leq 0.33$	-	-	800	mA
R1	bias resistor 1 (input)		0.7	1	1.3	k $\Omega$
R2/R1	bias resistor ratio		0.9	1	1.1	

[1] Device mounted on an FR4 Printed-Circuit Board (PCB), single-sided copper, tin-plated and standard footprint.

## 2. Pinning information

Table 3. Pinning

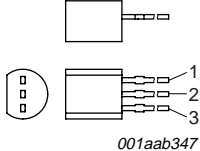
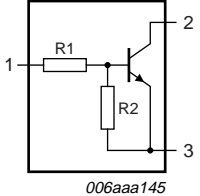
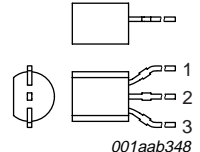
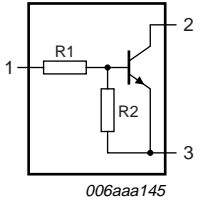
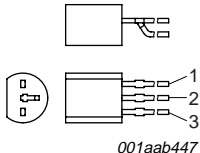
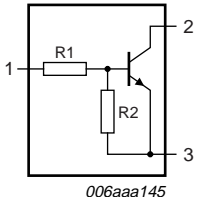
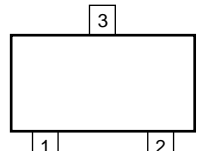
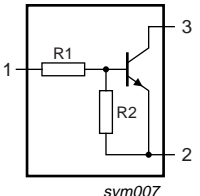
Pin	Description	Simplified outline	Symbol
<b>SOT54</b>			
1	input (base)	 001aab347	 006aaa145
2	output (collector)		
3	GND (emitter)		
<b>SOT54A</b>			
1	input (base)	 001aab348	 006aaa145
2	output (collector)		
3	GND (emitter)		
<b>SOT54 variant</b>			
1	input (base)	 001aab447	 006aaa145
2	output (collector)		
3	GND (emitter)		
<b>SOT23; SOT346</b>			
1	input (base)	 006aaa144	 sym007
2	GND (emitter)		
3	output (collector)		

### 3. Ordering information

**Table 4. Ordering information**

Type number	Package		
	Name	Description	Version
PBRN113EK	SC-59A	plastic surface-mounted package; 3 leads	SOT346
PBRN113ES <sup>[1]</sup>	SC-43A	plastic single-ended leaded (through hole) package; 3 leads	SOT54
PBRN113ET	-	plastic surface-mounted package; 3 leads	SOT23

[1] Also available in SOT54A and SOT54 variant packages (see [Section 2](#) and [Section 9](#)).

### 4. Marking

**Table 5. Marking codes**

Type number	Marking code <sup>[1]</sup>
PBRN113EK	G1
PBRN113ES	N113ES
PBRN113ET	*7G

[1] \* = -: made in Hong Kong  
 \* = p: made in Hong Kong  
 \* = t: made in Malaysia  
 \* = W: made in China

### 5. Limiting values

**Table 6. Limiting values**

*In accordance with the Absolute Maximum Rating System (IEC 60134).*

Symbol	Parameter	Conditions	Min	Max	Unit
$V_{CBO}$	collector-base voltage	open emitter	-	40	V
$V_{CEO}$	collector-emitter voltage	open base	-	40	V
$V_{EBO}$	emitter-base voltage	open collector	-	10	V
$V_I$	input voltage				
	positive		-	+10	V
	negative		-	-10	V
$I_O$	output current				
	PBRN113EK, PBRN113ET		<sup>[1]</sup> -	600	mA
			<sup>[2][3]</sup> -	700	mA
	PBRN113ES		<sup>[1]</sup> -	800	mA
$I_{ORM}$	repetitive peak output current				
	PBRN113EK, PBRN113ET	$t_p \leq 1$ ms; $\delta \leq 0.33$	-	800	mA

**Table 6. Limiting values ...continued**

In accordance with the Absolute Maximum Rating System (IEC 60134).

Symbol	Parameter	Conditions	Min	Max	Unit		
$P_{tot}$	total power dissipation	$T_{amb} \leq 25\text{ }^{\circ}\text{C}$					
			PBRN113EK, PBRN113ET	[1]	-	250	mW
				[2]	-	370	mW
				[3]	-	570	mW
	PBRN113ES		[1]	-	700	mW	
$T_j$	junction temperature		-	150	$^{\circ}\text{C}$		
$T_{amb}$	ambient temperature		-65	+150	$^{\circ}\text{C}$		
$T_{stg}$	storage temperature		-65	+150	$^{\circ}\text{C}$		

[1] Device mounted on an FR4 PCB, single-sided copper, tin-plated and standard footprint.

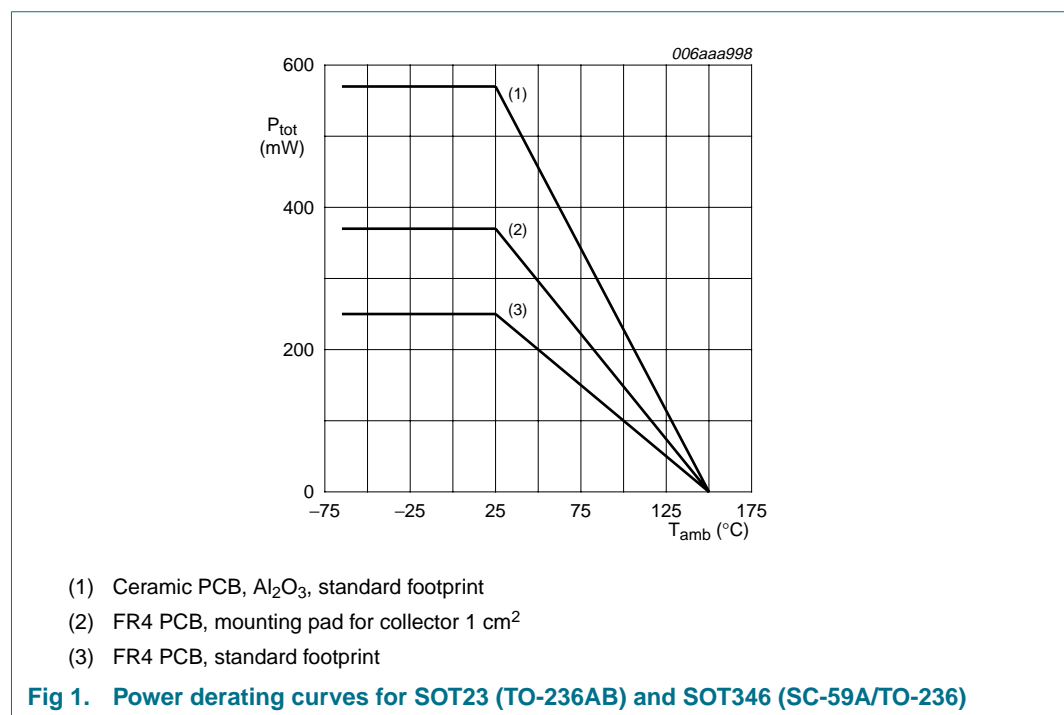
[2] Device mounted on an FR4 PCB, single-sided copper, tin-plated, mounting pad for collector 1 cm<sup>2</sup>.[3] Device mounted on a ceramic PCB, Al<sub>2</sub>O<sub>3</sub>, standard footprint.

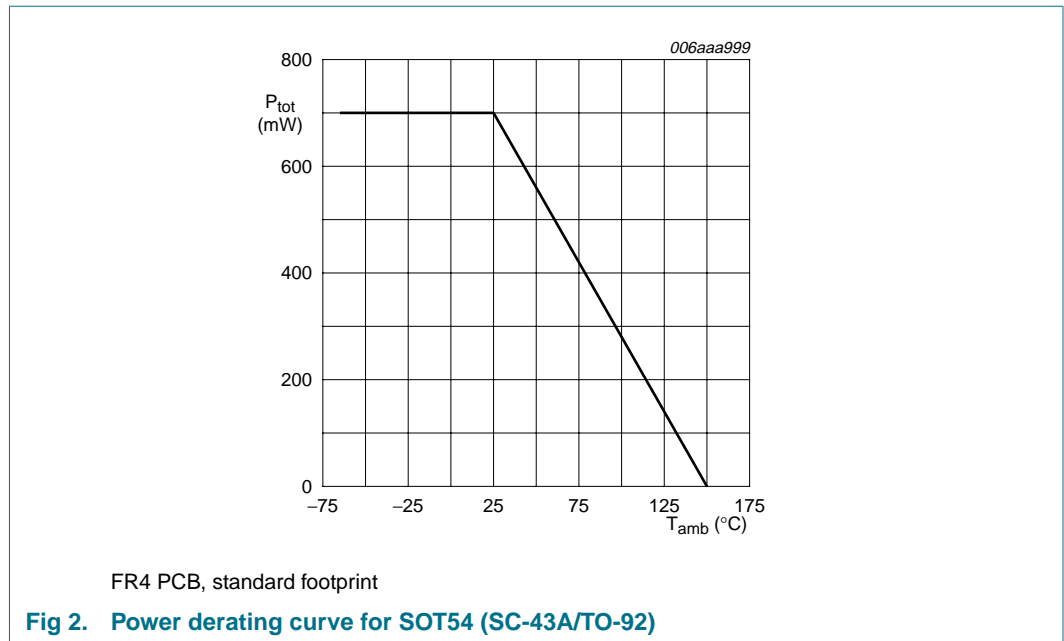

## 6. Thermal characteristics

**Table 7. Thermal characteristics**

Symbol	Parameter	Conditions	Min	Typ	Max	Unit	
$R_{th(j-a)}$	thermal resistance from junction to ambient	in free air	[1]	-	-	500	K/W
			[2]	-	-	338	K/W
			[3]	-	-	219	K/W
			PBRN113ES	[1]	-	-	179
$R_{th(j-sp)}$	thermal resistance from junction to solder point		-	-	105	K/W	
			PBRN113EK, PBRN113ET	-	-	105	K/W

[1] Device mounted on an FR4 PCB, single-sided copper, tin-plated and standard footprint.

[2] Device mounted on an FR4 PCB, single-sided copper, tin-plated, mounting pad for collector 1 cm<sup>2</sup>.

[3] Device mounted on a ceramic PCB, Al<sub>2</sub>O<sub>3</sub>, standard footprint.

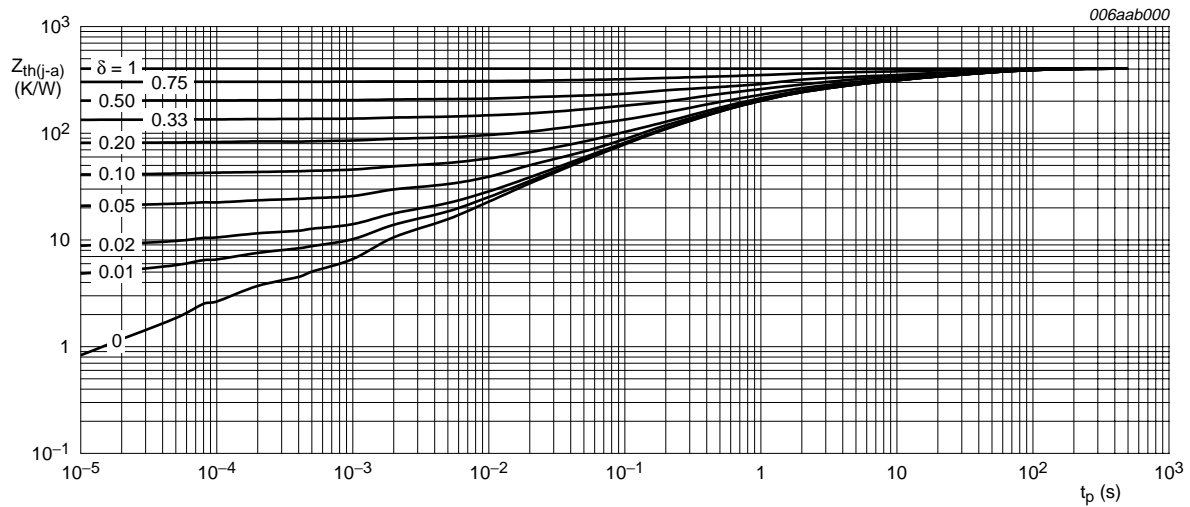

FR4 PCB, standard footprint

**Fig 3. Transient thermal impedance from junction to ambient as a function of pulse duration for SOT23 (TO-236AB) and SOT346 (SC-59A/TO-236); typical values**

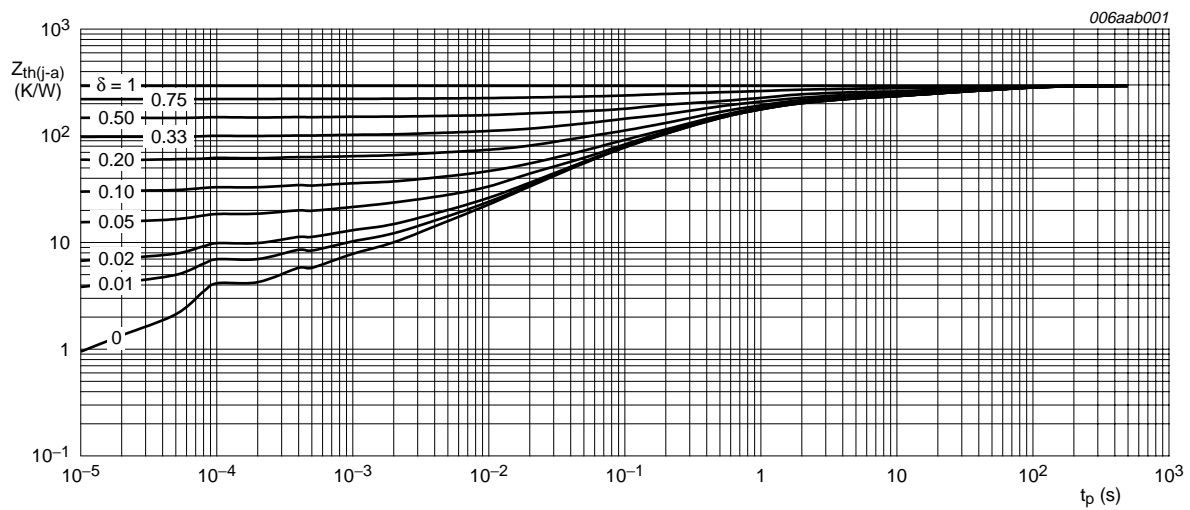
FR4 PCB, mounting pad for collector 1 cm<sup>2</sup>

**Fig 4. Transient thermal impedance from junction to ambient as a function of pulse duration for SOT23 (TO-236AB) and SOT346 (SC-59A/TO-236); typical values**

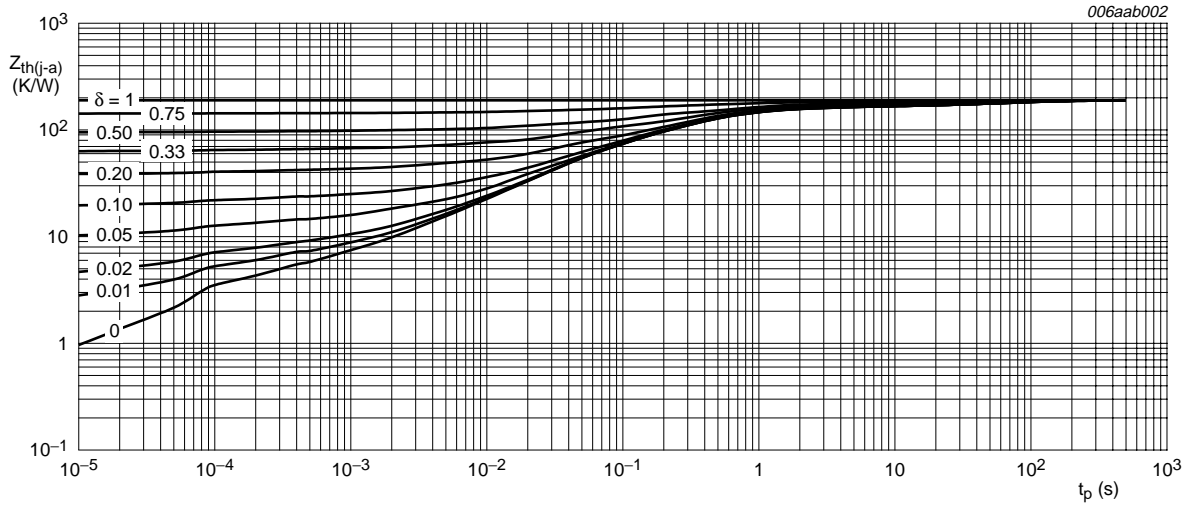

Ceramic PCB, Al<sub>2</sub>O<sub>3</sub>, standard footprint

**Fig 5. Transient thermal impedance from junction to ambient as a function of pulse duration for SOT23 (TO-236AB) and SOT346 (SC-59A/TO-236); typical values**

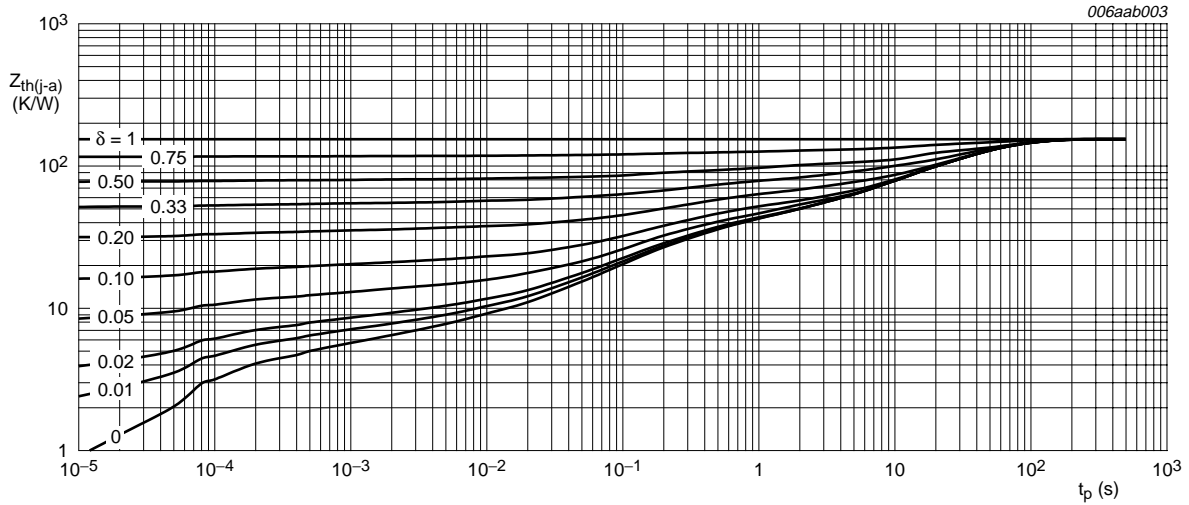

FR4 PCB, standard footprint

**Fig 6. Transient thermal impedance from junction to ambient as a function of pulse duration for SOT54 (SC-43A/TO-92); typical values**

## 7. Characteristics

**Table 8. Characteristics**
 $T_{amb} = 25^{\circ}\text{C}$  unless otherwise specified.

Symbol	Parameter	Conditions	Min	Typ	Max	Unit
$I_{CBO}$	collector-base cut-off current	$V_{CB} = 30\text{ V};$ $I_E = 0\text{ A}$	-	-	100	nA
$I_{CEO}$	collector-emitter cut-off current	$V_{CE} = 30\text{ V};$ $I_B = 0\text{ A}$	-	-	0.5	$\mu\text{A}$
$I_{EBO}$	emitter-base cut-off current	$V_{EB} = 5\text{ V};$ $I_C = 0\text{ A}$	-	-	4	mA
$h_{FE}$	DC current gain	$V_{CE} = 5\text{ V};$ $I_C = 50\text{ mA}$	40	75	-	
		$V_{CE} = 5\text{ V};$ $I_C = 300\text{ mA}$	[1] 180	300	-	
		$V_{CE} = 5\text{ V};$ $I_C = 600\text{ mA}$	[1] 250	400	-	
		$V_{CE} = 5\text{ V};$ $I_C = 800\text{ mA}$	[1] 270	420	-	
$V_{CEsat}$	collector-emitter saturation voltage	$I_C = 50\text{ mA};$ $I_B = 2.5\text{ mA}$	-	25	35	mV
		$I_C = 200\text{ mA};$ $I_B = 10\text{ mA}$	-	60	85	mV
		$I_C = 500\text{ mA};$ $I_B = 10\text{ mA}$	[1] -	160	220	mV
		$I_C = 600\text{ mA};$ $I_B = 6\text{ mA}$	[1] -	320	550	mV
		$I_C = 800\text{ mA};$ $I_B = 8\text{ mA}$	[1] -	0.68	1.15	V
$V_{I(off)}$	off-state input voltage	$V_{CE} = 5\text{ V};$ $I_C = 100\text{ }\mu\text{A}$	0.6	1	1.5	V
$V_{I(on)}$	on-state input voltage	$V_{CE} = 0.3\text{ V};$ $I_C = 20\text{ mA}$	1	1.3	1.8	V
R1	bias resistor 1 (input)		0.7	1	1.3	k $\Omega$
R2/R1	bias resistor ratio		0.9	1	1.1	
$C_c$	collector capacitance	$V_{CB} = 10\text{ V};$ $I_E = i_e = 0\text{ A};$ $f = 1\text{ MHz}$	-	7	-	pF

[1] Pulse test:  $t_p \leq 300\text{ }\mu\text{s}; \delta \leq 0.02$ .



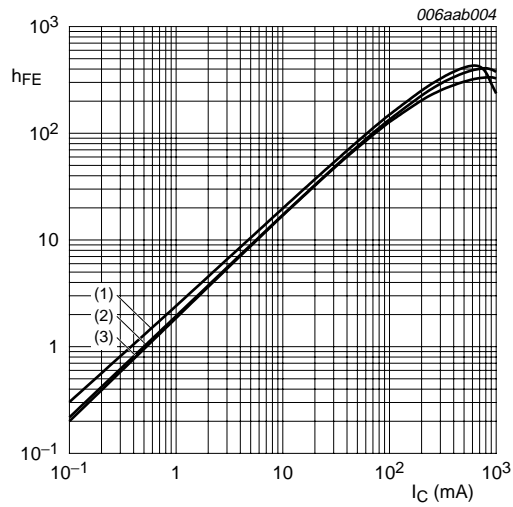

$V_{CE} = 5\text{ V}$   
 (1)  $T_{amb} = 100\text{ }^{\circ}\text{C}$   
 (2)  $T_{amb} = 25\text{ }^{\circ}\text{C}$   
 (3)  $T_{amb} = -40\text{ }^{\circ}\text{C}$

**Fig 7. DC current gain as a function of collector current; typical values**

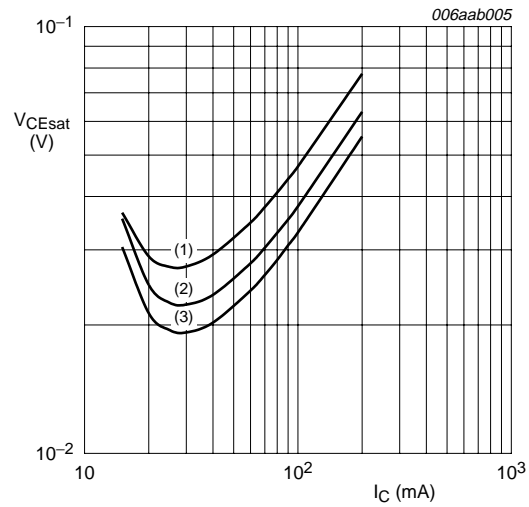

$I_C/I_B = 20$   
 (1)  $T_{amb} = 100\text{ }^{\circ}\text{C}$   
 (2)  $T_{amb} = 25\text{ }^{\circ}\text{C}$   
 (3)  $T_{amb} = -40\text{ }^{\circ}\text{C}$

**Fig 8. Collector-emitter saturation voltage as a function of collector current; typical values**

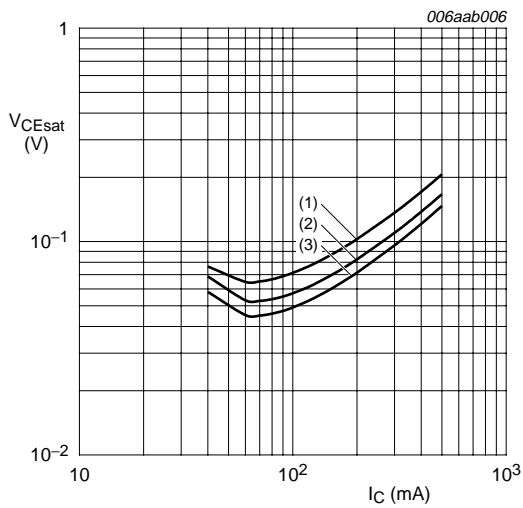

$I_C/I_B = 50$   
 (1)  $T_{amb} = 100\text{ }^{\circ}\text{C}$   
 (2)  $T_{amb} = 25\text{ }^{\circ}\text{C}$   
 (3)  $T_{amb} = -40\text{ }^{\circ}\text{C}$

**Fig 9. Collector-emitter saturation voltage as a function of collector current; typical values**

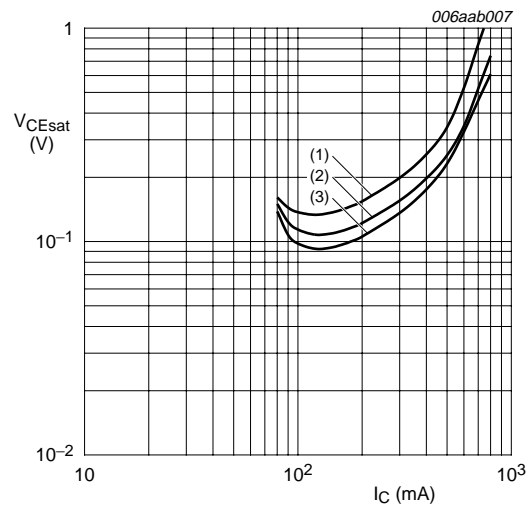

$I_C/I_B = 100$   
 (1)  $T_{amb} = 100\text{ }^{\circ}\text{C}$   
 (2)  $T_{amb} = 25\text{ }^{\circ}\text{C}$   
 (3)  $T_{amb} = -40\text{ }^{\circ}\text{C}$

**Fig 10. Collector-emitter saturation voltage as a function of collector current; typical values**

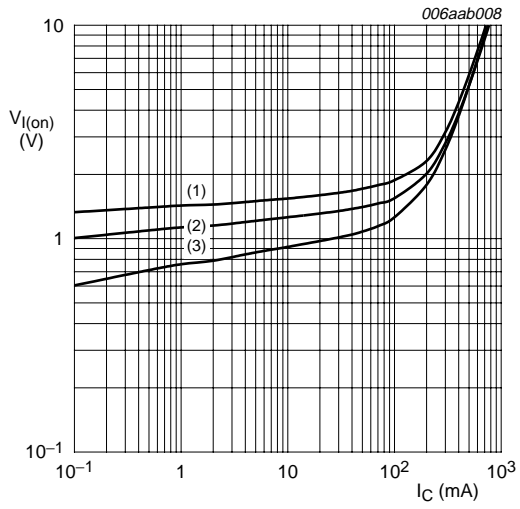

$V_{CE} = 0.3 \text{ V}$   
 (1)  $T_{amb} = -40 \text{ }^\circ\text{C}$   
 (2)  $T_{amb} = 25 \text{ }^\circ\text{C}$   
 (3)  $T_{amb} = 100 \text{ }^\circ\text{C}$

**Fig 11. On-state input voltage as a function of collector current; typical values**

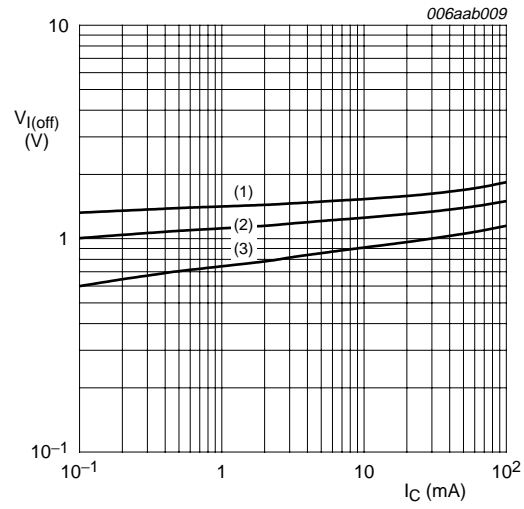

$V_{CE} = 5 \text{ V}$   
 (1)  $T_{amb} = -40 \text{ }^\circ\text{C}$   
 (2)  $T_{amb} = 25 \text{ }^\circ\text{C}$   
 (3)  $T_{amb} = 100 \text{ }^\circ\text{C}$

**Fig 12. Off-state input voltage as a function of collector current; typical values**

**8. Package outline**

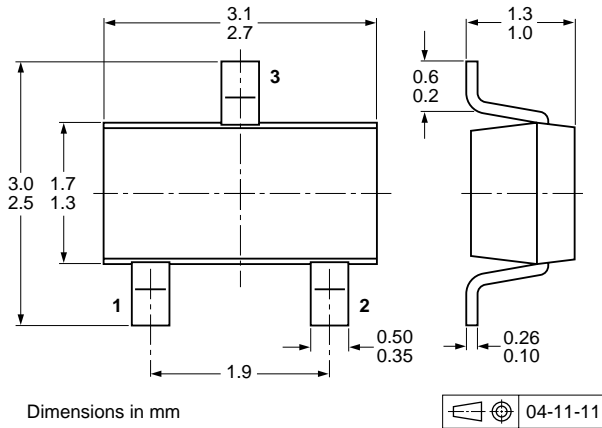

**Fig 13. Package outline SOT346 (SC-59A/TO-236)**

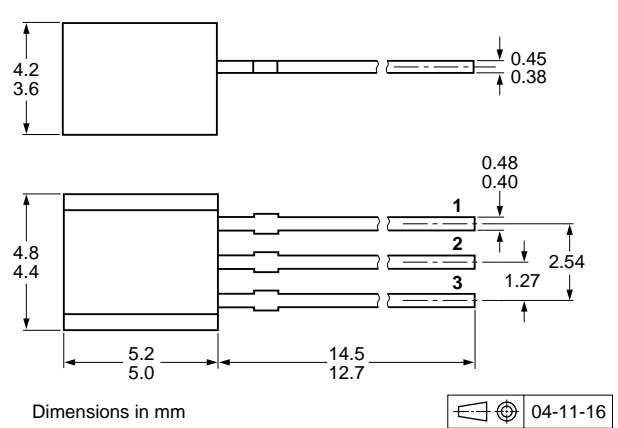

**Fig 14. Package outline SOT54 (SC-43A/TO-92)**

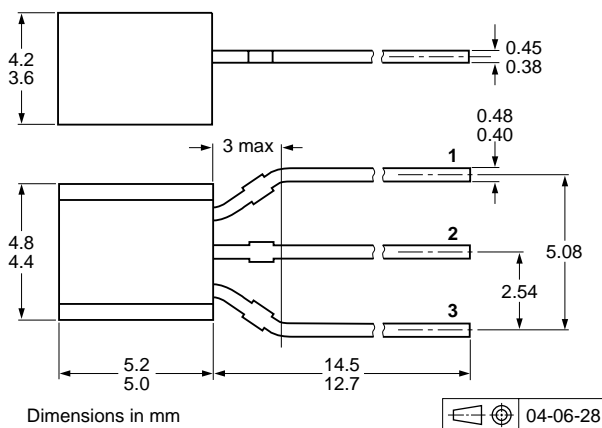

**Fig 15. Package outline SOT54A**

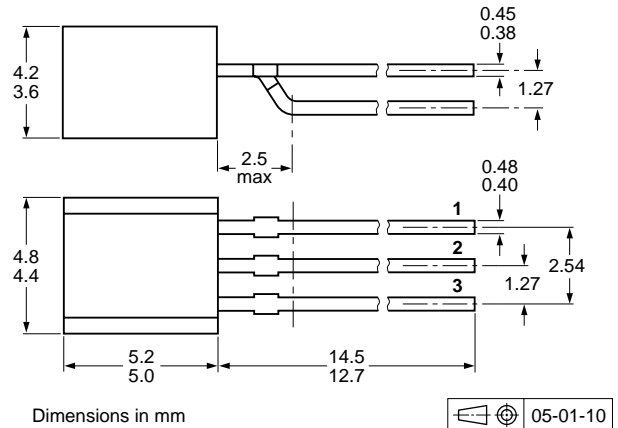

**Fig 16. Package outline SOT54 variant**

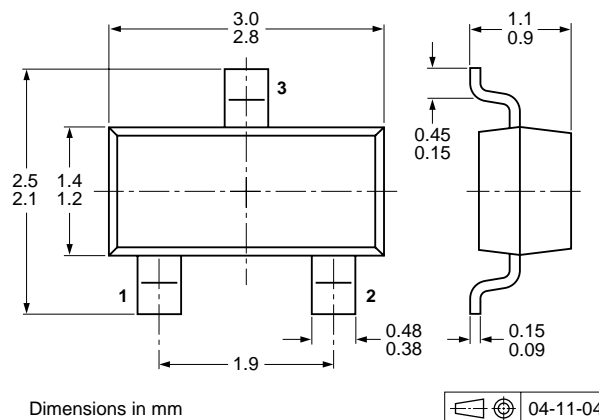

**Fig 17. Package outline SOT23 (TO-236AB)**

## 9. Packing information

**Table 9. Packing methods**

The indicated -xxx are the last three digits of the 12NC ordering code.<sup>[1]</sup>

Type number	Package	Description	Packing quantity		
			3000	5000	10000
PBRN113EK	SOT346	4 mm pitch, 8 mm tape and reel	-115	-	-135
PBRN113ES	SOT54	bulk, straight leads	-	-412	-
	SOT54A	tape and reel, wide pitch	-	-	-116
		tape ammpack, wide pitch	-	-	-126
	SOT54 variant	bulk, delta pinning	-	-112	-
PBRN113ET	SOT23	4 mm pitch, 8 mm tape and reel	-215	-	-235

[1] For further information and the availability of packing methods, see [Section 13](#).

## 10. Soldering

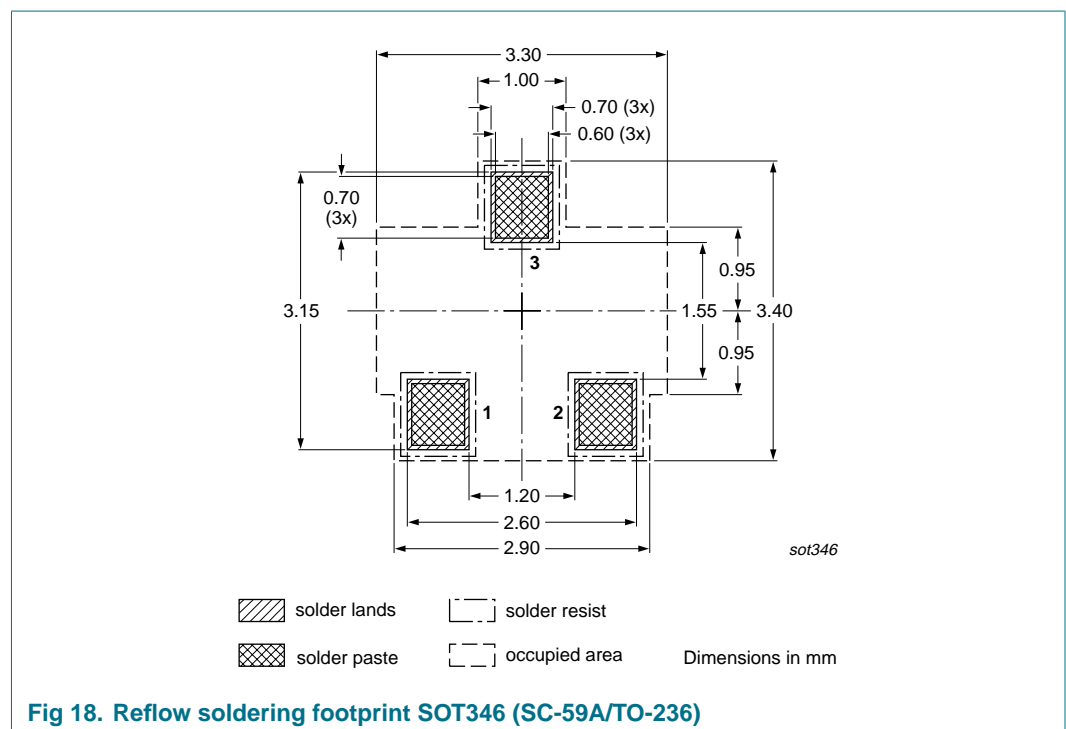

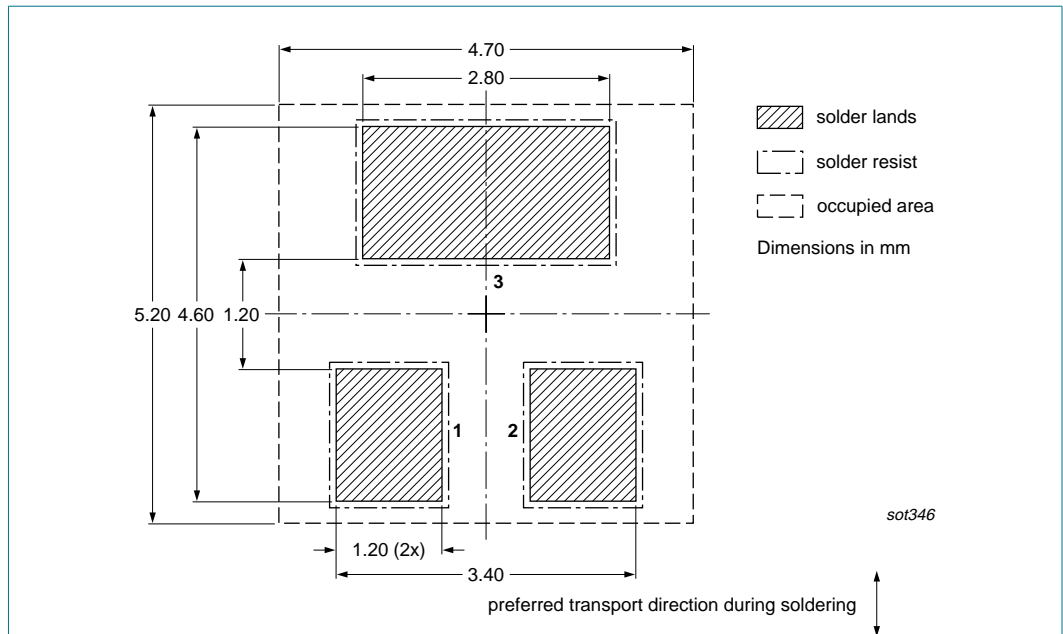

Fig 19. Wave soldering footprint SOT346 (SC-59A/TO-236)

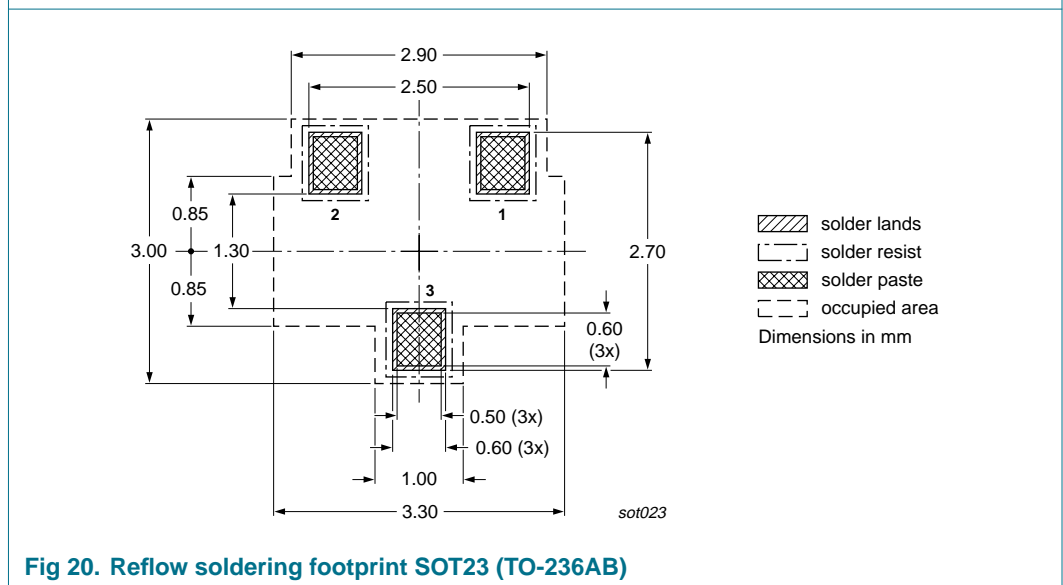
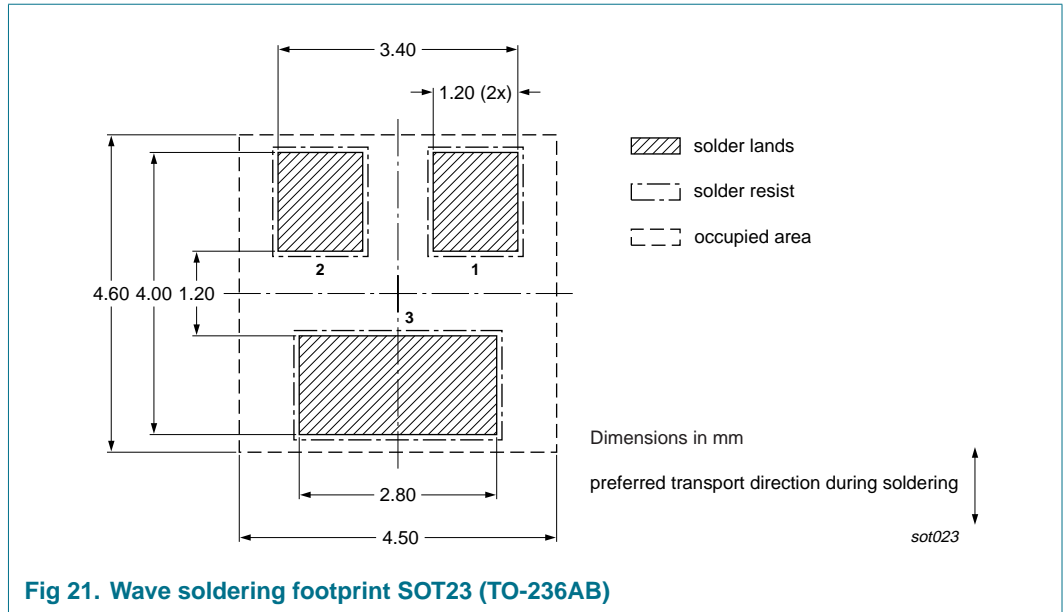

Fig 20. Reflow soldering footprint SOT23 (TO-236AB)



## 11. Revision history

**Table 10. Revision history**

Document ID	Release date	Data sheet status	Change notice	Supersedes
PBRN113E_SER_1	20070301	Product data sheet	-	-

## 12. Legal information

### 12.1 Data sheet status

Document status <sup>[1][2]</sup>	Product status <sup>[3]</sup>	Definition
Objective [short] data sheet	Development	This document contains data from the objective specification for product development.
Preliminary [short] data sheet	Qualification	This document contains data from the preliminary specification.
Product [short] data sheet	Production	This document contains the product specification.

[1] Please consult the most recently issued document before initiating or completing a design.

[2] The term 'short data sheet' is explained in section "Definitions".

[3] The product status of device(s) described in this document may have changed since this document was published and may differ in case of multiple devices. The latest product status information is available on the Internet at URL <http://www.nxp.com>.

### 12.2 Definitions

**Draft** — The document is a draft version only. The content is still under internal review and subject to formal approval, which may result in modifications or additions. NXP Semiconductors does not give any representations or warranties as to the accuracy or completeness of information included herein and shall have no liability for the consequences of use of such information.

**Short data sheet** — A short data sheet is an extract from a full data sheet with the same product type number(s) and title. A short data sheet is intended for quick reference only and should not be relied upon to contain detailed and full information. For detailed and full information see the relevant full data sheet, which is available on request via the local NXP Semiconductors sales office. In case of any inconsistency or conflict with the short data sheet, the full data sheet shall prevail.

### 12.3 Disclaimers

**General** — Information in this document is believed to be accurate and reliable. However, NXP Semiconductors does not give any representations or warranties, expressed or implied, as to the accuracy or completeness of such information and shall have no liability for the consequences of use of such information.

**Right to make changes** — NXP Semiconductors reserves the right to make changes to information published in this document, including without limitation specifications and product descriptions, at any time and without notice. This document supersedes and replaces all information supplied prior to the publication hereof.

**Suitability for use** — NXP Semiconductors products are not designed, authorized or warranted to be suitable for use in medical, military, aircraft, space or life support equipment, nor in applications where failure or

malfunction of a NXP Semiconductors product can reasonably be expected to result in personal injury, death or severe property or environmental damage. NXP Semiconductors accepts no liability for inclusion and/or use of NXP Semiconductors products in such equipment or applications and therefore such inclusion and/or use is at the customer's own risk.

**Applications** — Applications that are described herein for any of these products are for illustrative purposes only. NXP Semiconductors makes no representation or warranty that such applications will be suitable for the specified use without further testing or modification.

**Limiting values** — Stress above one or more limiting values (as defined in the Absolute Maximum Ratings System of IEC 60134) may cause permanent damage to the device. Limiting values are stress ratings only and operation of the device at these or any other conditions above those given in the Characteristics sections of this document is not implied. Exposure to limiting values for extended periods may affect device reliability.

**Terms and conditions of sale** — NXP Semiconductors products are sold subject to the general terms and conditions of commercial sale, as published at <http://www.nxp.com/profile/terms>, including those pertaining to warranty, intellectual property rights infringement and limitation of liability, unless explicitly otherwise agreed to in writing by NXP Semiconductors. In case of any inconsistency or conflict between information in this document and such terms and conditions, the latter will prevail.

**No offer to sell or license** — Nothing in this document may be interpreted or construed as an offer to sell products that is open for acceptance or the grant, conveyance or implication of any license under any copyrights, patents or other industrial or intellectual property rights.

### 12.4 Trademarks

Notice: All referenced brands, product names, service names and trademarks are the property of their respective owners.

## 13. Contact information

For additional information, please visit: <http://www.nxp.com>

For sales office addresses, send an email to: [salesaddresses@nxp.com](mailto:salesaddresses@nxp.com)



## 14. Contents

<b>1</b>	<b>Product profile</b> .....	<b>1</b>
1.1	General description .....	1
1.2	Features .....	1
1.3	Applications .....	1
1.4	Quick reference data .....	1
<b>2</b>	<b>Pinning information</b> .....	<b>2</b>
<b>3</b>	<b>Ordering information</b> .....	<b>3</b>
<b>4</b>	<b>Marking</b> .....	<b>3</b>
<b>5</b>	<b>Limiting values</b> .....	<b>3</b>
<b>6</b>	<b>Thermal characteristics</b> .....	<b>5</b>
<b>7</b>	<b>Characteristics</b> .....	<b>8</b>
<b>8</b>	<b>Package outline</b> .....	<b>11</b>
<b>9</b>	<b>Packing information</b> .....	<b>12</b>
<b>10</b>	<b>Soldering</b> .....	<b>12</b>
<b>11</b>	<b>Revision history</b> .....	<b>15</b>
<b>12</b>	<b>Legal information</b> .....	<b>16</b>
12.1	Data sheet status .....	16
12.2	Definitions .....	16
12.3	Disclaimers .....	16
12.4	Trademarks .....	16
<b>13</b>	<b>Contact information</b> .....	<b>16</b>
<b>14</b>	<b>Contents</b> .....	<b>17</b>

Please be aware that important notices concerning this document and the product(s) described herein, have been included in section 'Legal information'.

founded by

**PHILIPS**

© NXP B.V. 2007.

All rights reserved.

For more information, please visit: <http://www.nxp.com>For sales office addresses, please send an email to: [salesaddresses@nxp.com](mailto:salesaddresses@nxp.com)

Date of release: 1 March 2007

Document identifier: PBRN113E\_SER\_1