

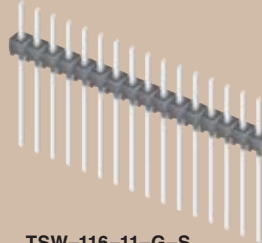

TSW-108-05-L-Q

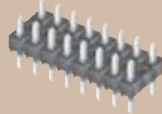

TSW-116-11-G-S

(2,54mm) .100"

TSW, HTSW SERIES

THROUGH-HOLE .025" SQ POST HEADER

Mates with:

SSW, SSQ, SSM, ESW, ESQ, BCS, BSW, CES, SLW, IDSD, IDSS, CLH

SPECIFICATIONS

For complete specifications see www.samtec.com?TSW

TSW

Insulator Material:

Black Glass Filled Polyester

Terminal Material:

Phosphor Bronze

Plating:

Au or Sn over 50µ" (1,27µm) Ni

Operating Temp Range:

-55°C to +125°C with Gold

-55°C to +105°C with Tin

Voltage Rating:

550 VAC mated with SSW;

500 VAC mated with BCS or ESQ;

450 VAC -RA/-RE mated with BCS or SSM

RoHS Compliant:

Yes

Lead-Free Solderable:

Wave Only



TYPE STRIP

TSW = Standard Strip

HTSW = Hi-Temp Strip

PIN CENTERS

-1 = .100" (2,54mm) Centers, All Positions Filled

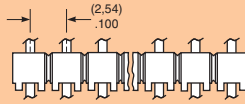

-2 = .200" (5,08mm) Centers, Every Other Position Filled

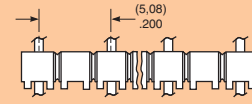

NO. PINS PER ROW

| CURRENT RATING | | | | | | |
|----------------|----------------|------|------|------|------|------|
| AMBIENT TEMP | TSW mated with | | | | | |
| | ESW | SSW | SLW | SSQ | SSM | BCS |
| 20°C | 6.9A | 6.9A | 7.1A | 7.6A | 6.9A | 5.9A |
| 40°C | 6A | 6.1A | 6.2A | 6.9A | 6A | 5.2A |
| 60°C | 5.3A | 5.3A | 5.8A | 5.9A | 5.3A | 4.7A |
| 95°C | 3.5A | 3.5A | 3.7A | 3.9A | 3.5A | 3A |

6 POSITIONS (2x3) POWERED

Straight Pin Versions

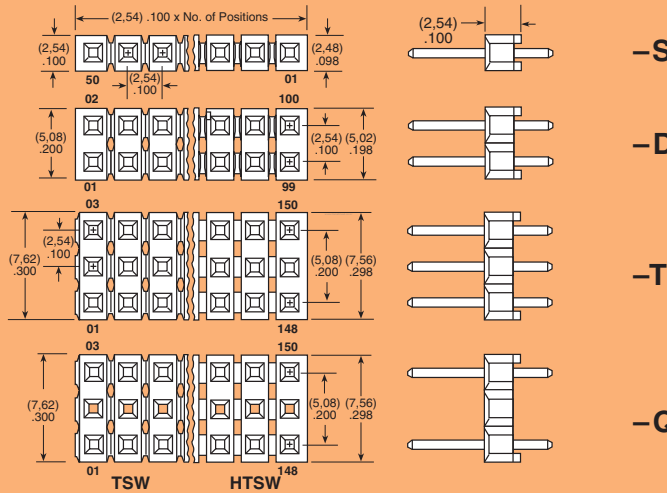

01 thru 50
= .100" (2,54mm) Center Version

Right Angle Versions

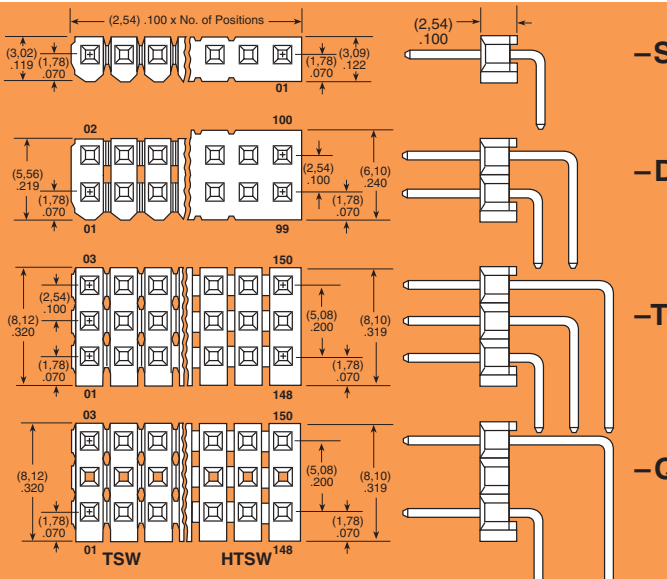

02 thru 25
= .200" (5,08mm) Center Version

SPECIFICATIONS

For complete specifications see www.samtec.com?HTSW

HTSW

Same as TSW except:

Insulator Material:

Natural Liquid Crystal Polymer



ALSO AVAILABLE

Shunts. See SNT Series

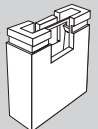

APPLICATIONS

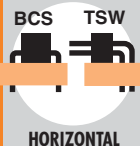

Note: Some lengths, styles and options are non-standard, non-returnable.

Due to technical progress, all designs, specifications and components are subject to change without notice.

WWW.SAMTEC.COM

TSW-109-10-F-D-RA

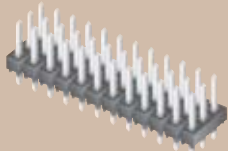

TSW-112-07-G-T

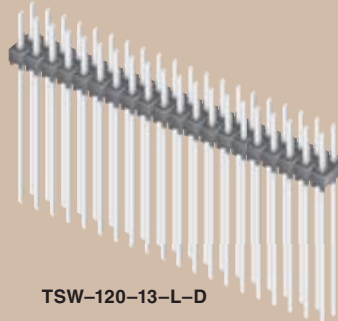

TSW-120-13-L-D

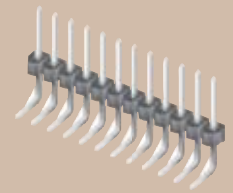

TSW-112-16-T-S-RE

LEAD STYLE

PLATING OPTION

ROW OPTION

OTHER OPTIONS

-F

= Gold flash on post, Matte Tin on tail

-L

= 10µ" (0,25µm) Gold on post, Matte Tin on tail

-G

= 10µ" (0,25µm) Gold on post, Gold flash on balance

-T

= Matte Tin

-SS

= 30µ" (0,76µm) Gold stripe on contact area, Gold flash to tip, Matte Tin on tail (Mates with SSW, SSQ, SSM, ESW, ESQ, BCS only) (Straight lead styles -07, -08, -09 and Right Angle (-RA) -08 only)

Specify -SS for cost-effective heavy Gold where it counts!

Note: Other Gold plating options available. Contact Samtec.

-S

= Single Row

-D

= Double Row

-T

= Triple Row

-Q

= Double Row (5,08mm) .200" row space

-RA or -RE

= Right Angle

-NA

= Right Angle (using straight body for coplanar mating with SSW-RA series)

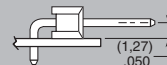

-LL

= Locking Lead

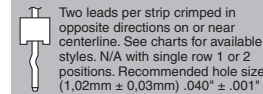

-LC

= Locking Clip (Styles -08 thru -13 & -22 only)

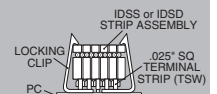

Requires 4 pin minimum (NA with -T, -Q, -RA or -RE)

-LA

= -RA Option with -LL Option

-"XXX"

= Polarized Position

Straight Pin Versions

(Specify "LEAD STYLE" from chart)

| STYLE | A | B | C |
|-------|-----------------|------------------|-----------------|
| * -05 | (3,30) .130 | (8,51) .335 | (2,67) .105 |
| * -06 | (2,41) .095 | (7,62) .300 | (2,67) .105 |
| * -07 | (2,54) .100 | (10,92) .430 | |
| * -08 | (5,08) .200 | (13,46) .530 | |
| -09 | (10,16) .400 | (18,54) .730 | |
| -10 | (12,70) .500 | (21,08) .830 | (5,84) .230 |
| -11 | (15,24) .600 | (23,62) .930 | |
| -12 | (17,78) .700 | (26,16) 1,030 | |
| -13 | (22,86) .900 | (31,24) 1,230 | |
| -14 | (2,79) .110 | (13,46) .530 | (8,13) .320 |
| * -15 | | (18,54) .730 | (13,21) .520 |
| * -16 | (7,87) .310 | | (8,13) .320 |
| * -17 | (2,79) .110 | (21,08) .830 | (15,74) .620 |

| STYLE | A | B | C |
|--------|------------------|------------------|------------------|
| * -18 | | (23,62) .930 | (18,29) .720 |
| * -19 | (2,79) .110 | (26,16) 1,030 | (20,83) .820 |
| * -20 | | (31,24) 1,230 | (25,91) 1,020 |
| * -21 | | (36,32) 1,430 | (30,99) 1,220 |
| * -22 | (7,62) .300 | (16,00) .630 | (5,84) .230 |
| * -23 | (2,92) .115 | (11,30) .445 | (6,73) .265 |
| * -24 | (5,33) .210 | (16,00) .630 | (8,13) .320 |
| * -25 | (3,20) .126 | (11,58) .456 | |
| ▲ -26 | (25,40) 1,000 | (33,78) 1,330 | (5,84) .230 |
| * -27 | (20,32) .800 | (28,70) 1,130 | |
| * -28 | (23,11) .910 | (33,78) 1,330 | (8,13) .320 |
| * -29 | (18,03) .710 | (28,70) 1,130 | |
| * -30 | (0,89) .035 | (9,27) .365 | (5,84) .230 |
| * -41+ | (1,27) .050 | (11,94) .470 | (8,13) .320 |

+ Style -41 & -42 available with HTSW only.

▲ Except: Style -26 (0,46) .018 DIA Tail

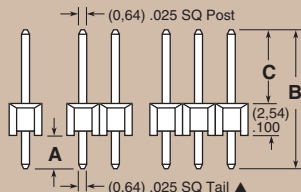

Specify -07 for best mate with IDXX Series IDC Cable

Right Angle Versions

(Specify "LEAD STYLE" from chart and select -RA or -RE from other options)

| -RA LEAD STYLE | SINGLE (-S) | | DOUBLE (-D) | TRIPLE (-T & -Q) | -RE LEAD STYLE | SINGLE (A) | C |
|----------------|-----------------|----------------|-----------------|------------------|----------------|-----------------|----------------|
| | A | C | A | A | | | |
| ** -08 | (2,29) .090 | | (2,29) .090 | (2,29) .090 | -09 | (4,83) .190 | |
| ** -09 | (7,37) .290 | | (7,37) .290 | (7,37) .290 | -10 | (7,37) .290 | |
| ** -10 | (9,91) .390 | (5,84) .230 | (9,91) .390 | (9,91) .390 | -11 | (9,91) .390 | (5,84) .230 |
| -11 | (12,45) .490 | | (12,45) .490 | (12,45) .490 | -12 | (12,45) .490 | |
| -12 | (14,99) .590 | | (14,99) .590 | (14,99) .590 | -13 | (17,53) .690 | |
| -13 | (20,07) .790 | | (20,07) .790 | N/A | -16 | (2,54) .100 | (8,13) .320 |
| * -16 | (5,08) .200 | (8,13) .320 | (5,08) .200 | (5,08) .200 | -21 | (22,61) .890 | |
| -21 | (25,15) .990 | (5,84) .230 | N/A | N/A | -22 | (2,29) .090 | (5,84) .230 |
| * -22 | (4,83) .190 | | (4,83) .190 | (4,83) .190 | -27 | (20,07) .790 | |
| * -25 | (2,54) .100 | (8,13) .320 | (2,54) .100 | (2,54) .100 | -28 | (17,53) .690 | |
| -27 | (22,61) .890 | (5,84) .230 | N/A | N/A | -29 | (20,32) .800 | |
| -28 | (17,53) .690 | | (17,53) .690 | N/A | -30 | (15,24) .600 | |
| -29 | (20,32) .800 | (8,13) .320 | N/A | N/A | | | |
| -30 | (15,24) .600 | | (15,24) .600 | | | | |

* Available with -LA (Locking Lead) Option

ALSO AVAILABLE

Elevated Right Angle option. Call Samtec.

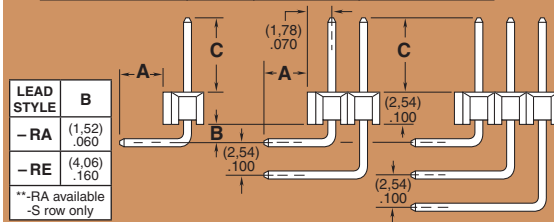

Due to technical progress, all designs, specifications and components are subject to change without notice.

WWW.SAMTEC.COM