



DTC123Y

NPN SILICON TRANSISTOR

NPN DIGITAL TRANSISTOR (BUILT-IN BIAS RESISTORS)

■ FEATURES

- * Built-in bias resistors that implies easy ON/OFF applications.
- * The bias resistors are thin-film resistors with complete isolation to allow negative input.

■ EQUIVALENT CIRCUIT

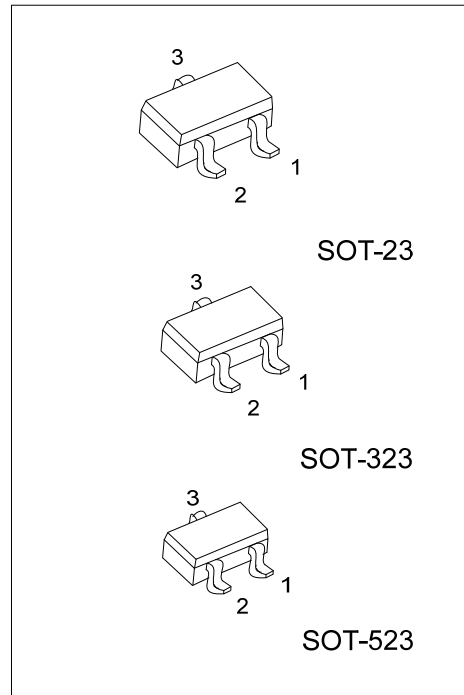
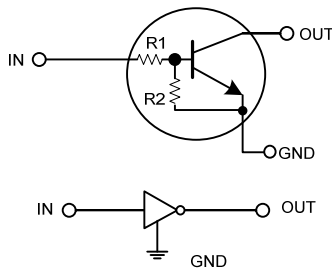

■ ORDERING INFORMATION

Ordering Number			Package	Pin Assignment			Packing
Normal	Lead Free	Halogen Free		1	2	3	
DTC123Y-AE3-R	DTC123YL-AE3-R	DTC123YG-AE3-R	SOT-23	G	I	O	Tape Reel
DTC123Y-AL3-R	DTC123YL-AL3-R	DTC123YG-AL3-R	SOT-323	G	I	O	Tape Reel
DTC123Y-AN3-R	DTC123YL-AN3-R	DTC123YG-AN3-R	SOT-523	G	I	O	Tape Reel

<p>DTC123YL-AE3-R</p> <p>(1)Packing Type (2)Package Type (3)Lead Plating</p>	<p>(1) R: Tape Reel (2) AE3: SOT-23, AL3: SOT-323, AN3: SOT-523 (3) G: Halogen Free, L: Lead Free, Blank: Pb/Sn</p>
--	---

■ MARKING

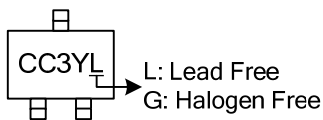

■ ABSOLUTE MAXIMUM RATING (Ta=25°C)

PARAMETER		SYMBOL	RATINGS	UNIT
Supply Voltage		V _{CC}	50	V
Input Voltage		V _{IN}	-5 ~ +12	V
Output Current		I _{OUT}	100	mA
		I _{C(MAX)}	100	mA
Power Dissipation	SOT-23/SOT-323	P _D	200	mW
	SOT-523		150	mW
Storage Temperature		T _J	+150	°C
Junction Temperature		T _{STG}	-55~+150	°C

Note: Absolute maximum ratings are those values beyond which the device could be permanently damaged.

Absolute maximum ratings are stress ratings only and functional device operation is not implied.

■ ELECTRICAL CHARACTERISTICS (T_a=25°C, unless otherwise specified)

PARAMETER	SYMBOL	TEST CONDITIONS	MIN	TYP	MAX	UNIT
Input Voltage	V _{IN(OFF)}	V _{CC} =5V, I _{OUT} =100μA			0.3	V
	V _{IN(ON)}	V _{OUT} =0.3V, I _{OUT} =20mA	3			V
Output Voltage	V _{OUT(ON)}	I _{OUT} /I _{IN} =10mA/0.5mA		0.1	0.3	V
Input Current	I _{IN}	V _{IN} =5V			3.8	mA
Output Current	I _{OUT(OFF)}	V _{CC} =50V, V _{IN} =0V			0.5	μA
DC Current Gain	h _{FE}	V _{OUT} =5V, I _{OUT} =10mA	33			
Input Resistance	R ₁		1.54	2.2	2.86	KΩ
Resistance Ratio	R ₂ /R ₁		3.6	4.5	5.5	
Transition Frequency	f _T	V _{CE} =10V, I _E =-5mA, f=100MHz(Note)		250		MHz

Note: Transition frequency of the device

TYPICAL CHARACTERISTICS

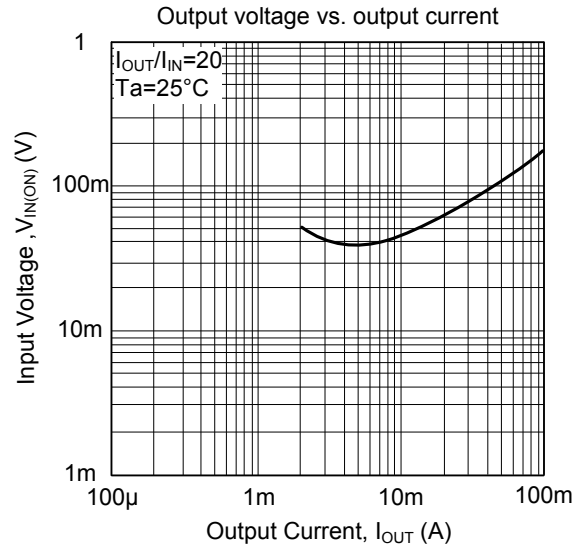
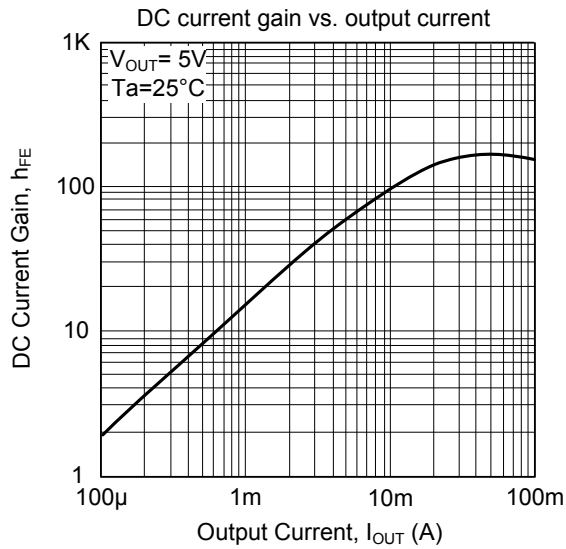
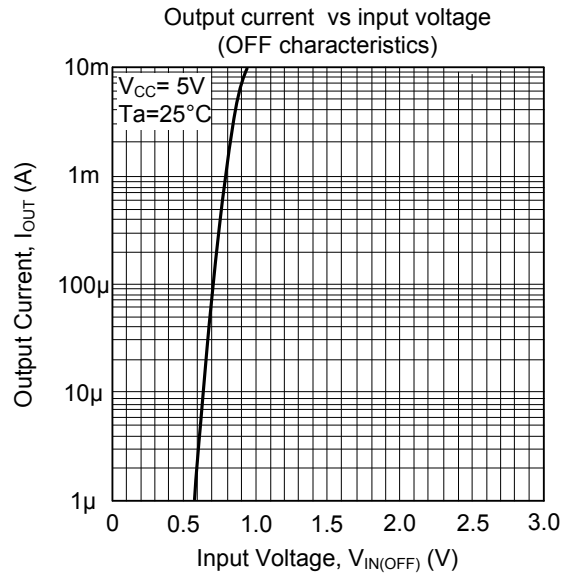
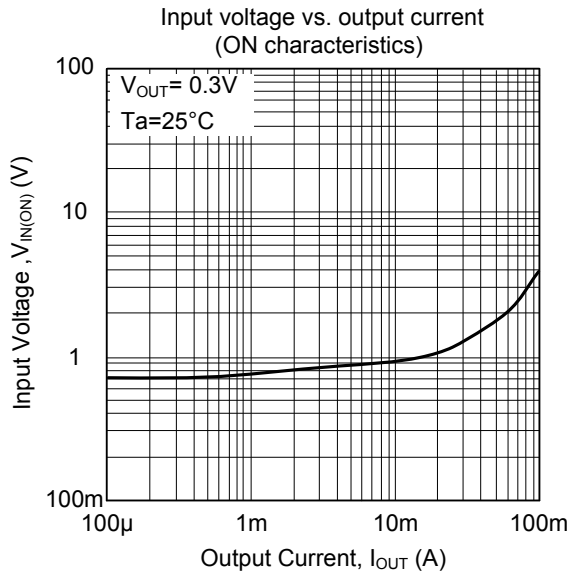

UTC assumes no responsibility for equipment failures that result from using products at values that exceed, even momentarily, rated values (such as maximum ratings, operating condition ranges, or other parameters) listed in products specifications of any and all UTC products described or contained herein. UTC products are not designed for use in life support appliances, devices or systems where malfunction of these products can be reasonably expected to result in personal injury. Reproduction in whole or in part is prohibited without the prior written consent of the copyright owner. The information presented in this document does not form part of any quotation or contract, is believed to be accurate and reliable and may be changed without notice.