

MULTI-FUNCTIONAL SWITCHES

Multi-Way Switches, JXS III Series

Pb Free

■ Features

1. Profile as low as only 2.3mm.
2. Sharp index feedback is ensured by the metal contact structure employed.
3. Externally measures 10.0mm × 10.0mm × 2.3mm.
4. Reflow-solderable.
5. 4 way and center push operation are possible.

■ Specification

1. Rating : 20mA 12V DC
2. Operating Force : Lever Switch 1.2±0.6N
Push Switch 3±1.5N
3. Operating Angle : 4⁺³₋₂°
4. Push Stroke : 0.2mm
5. Operating Life : 50,000 cycles

■ Application

Cellular phone, LCD TV and PDA, etc.

■ Tape Dimensions

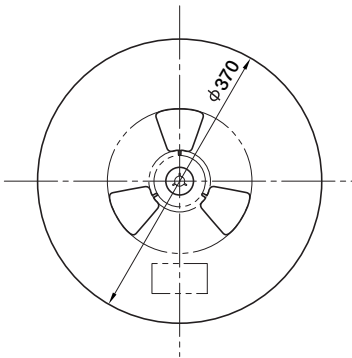

■ Reel Dimensions

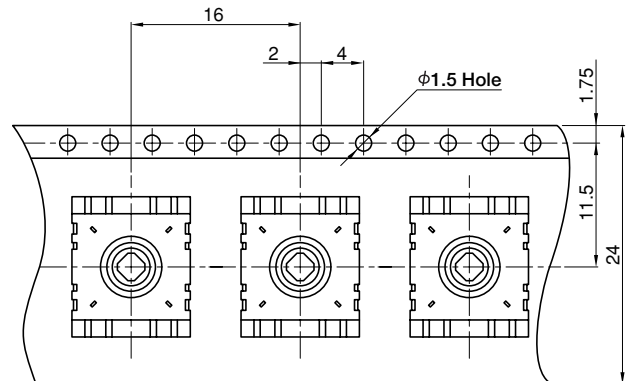

■ Packing Style

Packing Spec.	Part No.
Pack in Bulk	JXS0000-0501
	JXS0000-0601
	JXS0000-0701
	JXS0000-0801
Embossed Taping Pack	JXS0000-0511
	JXS0000-0611
	JXS0000-0711
	JXS0000-0811



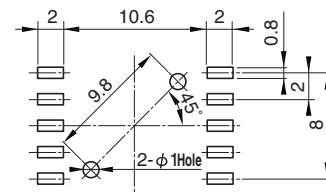



P.C.Board Dimension

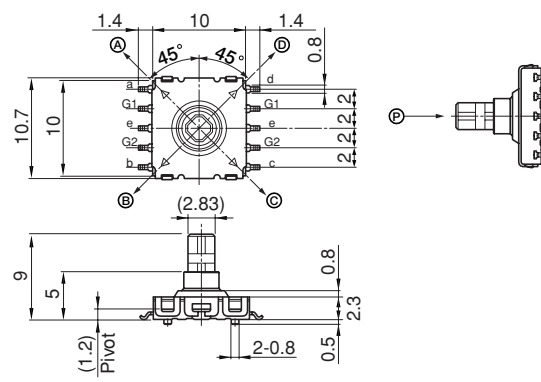
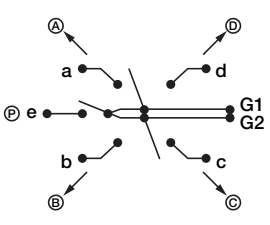

□□	Packing
01	Product Part No.
11	Embossed Taping Pack

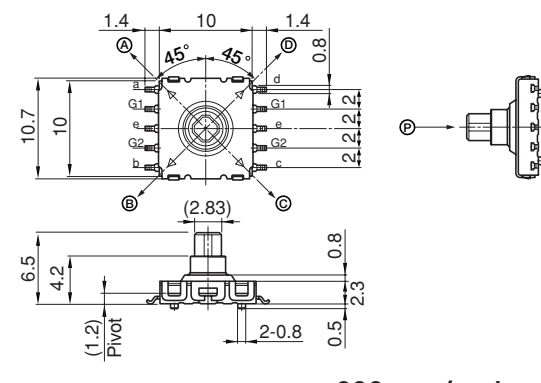
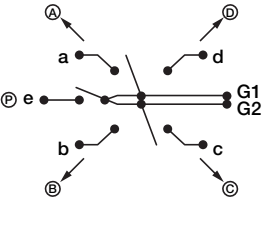
* 01 is product part No. and delivery will be made on embossed tape.

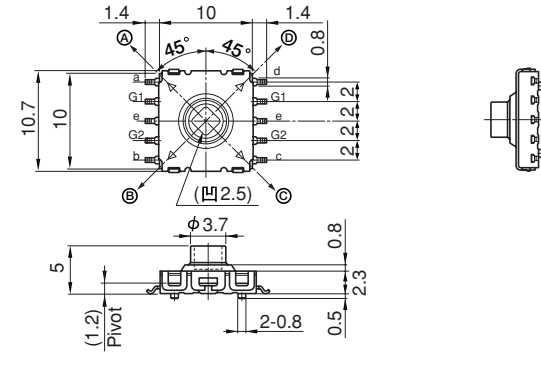
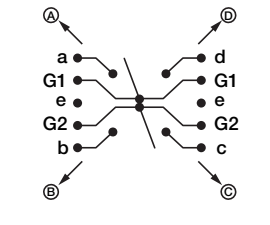
MULTI-FUNCTIONAL SWITCHES Pb Free

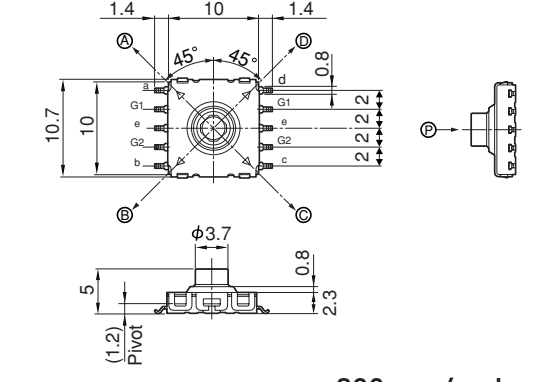
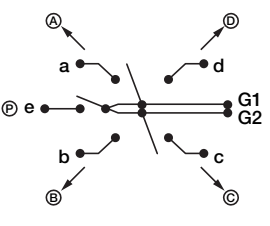
<p>JXS0000-05□□</p>  <p>(With Center Push)</p>	 <p>500 pcs/reel</p>	<p>Circuit</p>  <p>(G1 and G2 shorted on circuit board.</p>
<p>JXS0000-06□□</p>  <p>(With Center Push)</p>	 <p>600 pcs/reel</p>	<p>Circuit</p>  <p>(G1 and G2 shorted on circuit board.</p>
<p>JXS0000-07□□</p>  <p>(Without Center Push)</p>	 <p>800 pcs/reel</p>	<p>Circuit</p>  <p>(G1 and G2 shorted on circuit board.</p>
<p>JXS0000-08□□</p>  <p>(With Center Push)</p>	 <p>800 pcs/reel</p>	<p>Circuit</p>  <p>(G1 and G2 shorted on circuit board.</p>