

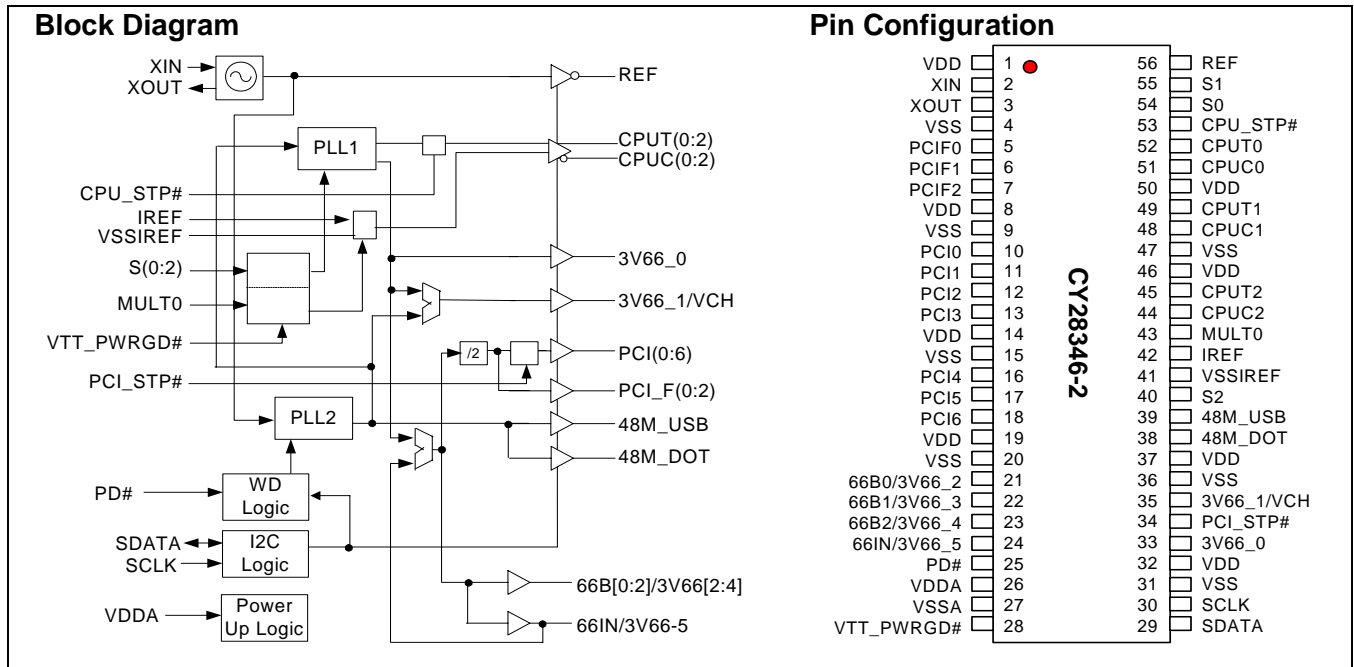
## Clock Synthesizer with Differential CPU Outputs

### Features

- Compliant with Intel® CK 408 Mobile Clock Synthesizer specifications
- 3.3V power supply
- 3 differential CPU clocks
- 10 copies of PCI clocks
- 5/6 copies of 3V66 clocks
- SMBus support with Read Back capabilities
- Spread Spectrum electromagnetic interference (EMI) reduction
- Dial-a-Frequency® features
- Dial-a-dB™ features
- Extended operating temperature range, 0°C to 85°C
- 56-pin TSSOP packages

Table 1. Frequency Table<sup>[1]</sup>

S2	S1	S0	CPU (0:2)	3V66	66BUFF(0:2)/3V66(0:4)	66IN/3V66-5	PCIF/PCI	REF	USB/DOT
1	0	0	66M	66M	66IN	66-MHz clock input	66IN/2	14.318M	48M
1	0	1	100M	66M	66IN	66-MHz clock input	66IN/2	14.318M	48M
1	1	0	200M	66M	66IN	66-MHz clock input	66IN/2	14.318M	48M
1	1	1	133M	66M	66IN	66-MHz clock input	66IN/2	14.318M	48M
0	0	0	66M	66M	66M	66M	33 M	14.318M	48M
0	0	1	100M	66M	66M	66M	33 M	14.318M	48M
0	1	0	200M	66M	66M	66M	33 M	14.318M	48M
0	1	1	133M	66M	66M	66M	33 M	14.318M	48M
M	0	0	Hi-Z	Hi-Z	Hi-Z	Hi-Z	Hi-Z	Hi-Z	Hi-Z
M	0	1	TCLK/2	TCLK/4	TCLK/4	TCLK/4	TCLK/8	TCLK	TCLK/2



**Note:**

1. TCLK is a test clock driven on the XTAL\_IN input during test mode. M = driven to a level between 1.0V and 1.8V. If the S2 pin is at a M level during power-up, a 0 state will be latched into the devices internal state register.

**Pin Description**

Pin	Name	PWR	I/O	Description
2	XIN	VDD	I	<b>Oscillator Buffer Input.</b> Connect to a crystal or to an external clock.
3	XOUT	VDD	O	<b>Oscillator Buffer Output.</b> Connect to a crystal. Do not connect when an external clock is applied at XIN.
52, 51, 49, 48, 45, 44	CPUT(0:2), CPUC(0:2)	VDD	O	<b>Differential host output clock pairs.</b> See <i>Table 1</i> for frequencies and functionality.
10, 11, 12, 13, 16, 17, 18	PCI(0:6)	VDDP	O	<b>PCI clock outputs.</b> Are synchronous to 66IN or 3V66 clock. See <i>Table 1</i> .
5, 6, 7	PCIF (0:2)	VDD	O	<b>33-MHz PCI clocks, which are 2 copies of 66IN or 3V66 clocks, may be free running (not stopped when PCI_STP# is asserted LOW) or may be stoppable depending on the programming of SMBus register Byte3, Bits (3:5).</b>
56	REF	VDD	O	<b>Buffered output copy of the device's XIN clock.</b>
42	IREF	VDD	I	<b>Current reference programming input for CPU buffers.</b> A resistor is connected between this pin and VSSIREF.
28	VTT_PWRGD#	VDD	I	<b>Qualifying input that latches S(0:2) and MULT0.</b> When this input is at a logic low, the S(0:2) and MULT0 are latched.
39	48M_USB	VDD48	O	<b>Fixed 48-MHz USB clock outputs.</b>
38	48M_DOT	VDD48	O	<b>Fixed 48-MHz DOT clock outputs.</b>
33	3V66_0	VDD	O	<b>3.3V 66-MHz fixed frequency clock.</b>
35	3V66_1/VCH	VDD	O	<b>3.3V clock selectable with SMBus byte0, Bit5, when Byte5, Bit5.</b> When Byte 0 Bit 5 is at a logic 1, then this pin is a 48M output clock. When byte0, Bit5 is a logic 0, then this is a 66M output clock (default).
25	PD#	VDD	I PU	<b>This pin is a power-down mode pin.</b> A logic LOW level causes the device to enter a power-down state. All internal logic is turned off except for the SMBus logic. All output buffers are stopped.
43	MULT0	VDD	I PU	<b>Programming input selection for CPU clock current multiplier.</b>
55, 54	S(0,1)	I	I	<b>Frequency select inputs.</b> See <i>Table 1</i>
29	SDATA	I	I	<b>Serial data input.</b> Conforms to the SMBus specification of a Slave Receive/Transmit device. It is an input when receiving data. It is an open drain output when acknowledging or transmitting data.
30	SCLK	I	I	<b>Serial clock input.</b> Conforms to the SMBus specification.
40	S2	VDD	I T	<b>Frequency select input.</b> See <i>Table 1</i> . This is a Tri-level input that is driven HIGH, LOW, or driven to a intermediate level.
34	PCI_STP#	VDD	I PU	<b>PCI clock disable input.</b> When asserted LOW, PCI (0:6) clocks are synchronously disabled in a LOW state. This pin does not effect PCIF (0:2) clocks' outputs if they are programmed to be PCIF clocks via the device's SMBus interface.
53	CPU_STP#	VDD	I PU	<b>CPU clock disable input.</b> When asserted LOW, CPUT (0:2) clocks are synchronously disabled in a HIGH state and CPUC(0:2) clocks are synchronously disabled in a LOW state.
24	66IN/3V66_5	VDD	I/O	<b>Input connection for 66CLK(0:2) output clock buffers if S2 = 1, or output clock for fixed 66-MHz clock if S2 = 0.</b> See <i>Table 1</i> .
21, 22, 23	66B(0:2)/3V66(2:4)	VDD	O	<b>3.3V clock outputs.</b> These clocks are buffered copies of the 66IN clock or fixed at 66 MHz. See <i>Table 1</i> .
1, 8, 14, 19, 32, 37, 46, 50	VDD	–	PWR	<b>3.3V power supply.</b>
4, 9, 15, 20, 27, 31, 36, 47	VSS	–	PWR	<b>Common ground.</b>

**Pin Description** (continued)

Pin	Name	PWR	I/O	Description
41	VSSIREF	–	PWR	<b>Current reference programming input for CPU buffers.</b> A resistor is connected between this pin and IREF. This pin should also be returned to device VSS.
26	VDDA	–	PWR	<b>Analog power input.</b> Used for PLL and internal analog circuits. It is also specifically used to detect and determine when power is at an acceptable level to enable the device to operate.

**Serial Data Interface**

To enhance the flexibility and function of the clock synthesizer, a two-signal serial interface is provided. Through the Serial Data Interface, various device functions, such as individual clock output buffers, can be individually enabled or disabled. The registers associated with the Serial Data Interface initialize to their default setting upon power-up, and therefore use of this interface is optional. Clock device register changes are normally made upon system initialization, if any are required. The interface can also be used during system operation for power management functions.

**Data Protocol**

The clock driver serial protocol accepts block write and block read operations from the controller. For block write/read operation, the bytes must be accessed in sequential order from lowest to highest byte (most significant bit first) with the ability to stop after any complete byte has been transferred.

The block write and block read protocol is outlined in *Table 2*. The slave receiver address is 11010010 (D2h).

**Table 2. Block Read and Block Write Protocol**

Block Write Protocol		Block Read Protocol	
Bit	Description	Bit	Description
1	Start	1	Start
2:8	Slave address – 7 bits	2:8	Slave address – 7 bits
9	Write = 0	9	Write = 0
10	Acknowledge from slave	10	Acknowledge from slave
11:18	Command Code – 8 bit '00000000' stands for block operation	11:18	Command Code – 8 bit '00000000' stands for block operation
19	Acknowledge from slave	19	Acknowledge from slave
20:27	Byte Count – 8 bits	20	Repeat start
28	Acknowledge from slave	21:27	Slave address – 7 bits
29:36	Data byte 1 – 8 bits	28	Read = 1
37	Acknowledge from slave	29	Acknowledge from slave
38:45	Data byte 2 – 8 bits	30:37	Byte count from slave – 8 bits
46	Acknowledge from slave	38	Acknowledge
....	.....	39:46	Data byte from slave – 8 bits
....	Data Byte (N-1) – 8 bits	47	Acknowledge
....	Acknowledge from slave	48:55	Data byte from slave – 8 bits
....	Data Byte N – 8 bits	56	Acknowledge
....	Acknowledge from slave	....	Data bytes from slave/Acknowledge
....	Stop	....	Data byte N from slave – 8 bits
		....	Not Acknowledge
		....	Stop

**Byte 0: CPU Clock Register**

Bit	@Pup	Name	Description
7	0		Spread Spectrum Enable, 0 = Spread Off, 1 = Spread On. This is a Read and Write control bit.
6	0		CPU clock Power-down Mode Select. 0 = Drive CPUT(0:2) to 4 or 6 IREF and drive CPUC(0:2) to low when PD# is asserted LOW. 1 = Three-state all CPU outputs. This is only applicable when PD# is LOW. It is not applicable to CPU_STP#.
5	0	3V66_1/VCH	3V66_1/VCH frequency Select, 0 = 66M selected, 1 = 48M selected This is a Read and Write control bit.
4	Pin 53	CPUT,CPUC	CPU_STP#. Reflects the current value of the external CPU_STP# (pin 53) This bit is Read-only.
3	Pin 34	PCI	Reflects the current value of the internal PCI_STP# function when read. Internally PCI_STP# is a logical AND function of the internal SMBus register bit and the external PCI_STP# pin.
2	Pin 40		Frequency Select Bit 2. Reflects the value of SEL2 (pin 40). This bit is Read-only.
1	Pin 55		Frequency Select Bit 1. Reflects the value of SEL1 (pin 55). This bit is Read-only.
0	Pin 54		Frequency Select Bit 0. Reflects the value of SEL0 (pin 54). This bit is Read-only.

**Byte 1: CPU Clock Register**

Bit	@Pup	Name	Description
7	Pin 43	MULT0	MULT0 (Pin 43) Value. This bit is Read-only.
6	0	CPU_STP#	Controls functionality of CPUT/C(0:2) outputs when CPU_STP# is asserted. 0 = Drive CPUT(0:2) to 4 or 6 IREF and drive CPUC(0:2) to low when CPU_STP# asserted LOW. 1 = Three-state all CPU outputs. This bit will override Byte0, Bit6 such that even if it is a 0, when PD# goes low the CPU outputs will be three-stated.
5	0	CPUT2 CPUC2	Controls CPU2 functionality when CPU_STP# is asserted LOW 1 = Free Running, 0 = Stopped LOW with CPU_STP# asserted LOW This is a Read and Write control bit.
4	0	CPUT1 CPUC1	Controls CPU1 functionality when CPU_STP# is asserted LOW 1 = Free Running, 0 = Stopped LOW with CPU_STP# asserted LOW This is a Read and Write control bit.
3	0	CPUT0 CPUC0	Controls CPUT0 functionality when CPU_STP# is asserted LOW 1 = Free Running, 0 = Stopped LOW with CPU_STP# asserted LOW This is a Read and Write control bit.
2	1	CPUT2 CPUC2	CPUT/C2 Output Control, 1 = enabled, 0 = disable HIGH and CPUC2 disables LOW This is a Read and Write control bit.
1	1	CPUT1 CPUC1	CPUT/C1 Output Control, 1 = enabled, 0 = disable HIGH and CPUC1 disables LOW This is a Read and Write control bit.
0	1	CPUT0 CPUC0	CPUT/C0 Output Control, 1 = enabled, 0 = disable HIGH and CPUC0 disables LOW This is a Read and Write control bit.

**Byte 2: PCI Clock Control Register (all bits are read and write functional)**

Bit	@Pup	Name	Description
7	0	REF	REF Output Control. 0 = high strength, 1 = low strength
6	1	PCI6	PCI6 Output Control. 1 = enabled, 0 = forced LOW
5	1	PCI5	PCI5 Output Control. 1 = enabled, 0 = forced LOW
4	1	PCI4	PCI4 Output Control. 1 = enabled, 0 = forced LOW
3	1	PCI3	PCI3 Output Control. 1 = enabled, 0 = forced LOW
2	1	PCI2	PCI2 Output Control. 1 = enabled, 0 = forced LOW
1	1	PCI1	PCI1 Output Control. 1 = enabled, 0 = forced LOW
0	1	PCI0	PCI0 Output Control. 1 = enabled, 0 = forced LOW

**Byte 3: PCIF Clock and 48M Control Register** (all bits are read and write functional)

Bit	@Pup	Name	Description
7	1	48M_DOT	48M_DOT Output Control, 1 = enabled, 0 = forced LOW
6	1	48M_USB	48M_USB Output Control, 1 = enabled, 0 = forced LOW
5	0	PCIF2	PCI_STP#, control of PCIF2. 0 = Free Running, 1 = Stopped when PCI_STP# is LOW
4	0	PCIF1	PCI_STP#, control of PCIF1. 0 = Free Running, 1 = Stopped when PCI_STP# is LOW
3	0	PCIF0	PCI_STP#, control of PCIF0. 0 = Free Running, 1 = Stopped when PCI_STP# is LOW
2	1	PCIF2	PCIF2 Output Control. 1=running, 0=forced LOW
1	1	PCIF1	PCIF1 Output Control. 1= running, 0=forced LOW
0	1	PCIF0	PCIF0 Output Control. 1= running, 0=forced LOW

**Byte 4: DRCG Control Register**(all bits are read and write functional)

Bit	@Pup	Name	Description
7	0		SS2 Spread Spectrum control bit (0 = down spread, 1 = center spread)
6	0		Reserved
5	1	3V66_0	3V66_0 Output Enabled. 1 = enabled, 0 = disabled
4	1	3V66_1/VCH	3V66_1/VCH Output Enable. 1 = enabled, 0 = disabled
3	1	3V66_5	3V66_5 Output Enable. 1 = enabled, 0 = disabled
2	1	66B2/3V66_4	66B2/3V66_4 Output Enabled. 1 = enabled, 0 = disabled
1	1	66B1/3V66_3	66B1/3V66_3 Output Enabled. 1 = enabled, 0 = disabled
0	1	66B0/3V66_2	66B0/3V66_2 Output Enabled. 1 = enabled, 0 = disabled

**Byte 5: Clock Control Register** (all bits are read and write functional)

Bit	@Pup	Name	Description
7	0		SS1 Spread Spectrum control bit
6	1		SS0 Spread Spectrum control bit
5	0		66IN to 66M delay Control MSB
4	0		66IN to 66M delay Control LSB
3	0		Reserved
2	0		48M_DOT edge rate control. When set to 1, the edge is slowed by 15%.
1	0		Reserved
0	0		USB edge rate control. When set to 1, the edge is slowed by 15%

**Byte 6: Silicon Signature Register<sup>[2]</sup>** (all bits are read-only)

Bit	@Pup	Name	Description
7	0		
6	0		
5	0		
4	1		
3	0		Vendor Code, 011 = IMI
2	0		
1	1		
0	1		

**Note:**

- When writing to this register the device will acknowledge the write operation, but the data itself will be ignored.

**Byte 7: Watchdog Time Stamp Register**

Bit	@Pup	Name	Description
7	0		Reserved
6	0		Reserved
5	0		Reserved
4	0		Reserved
3	0		Reserved
2	0		Reserved
1	0		Reserved
0	0		Reserved

**Byte 8: Dial-a-Frequency Control Register N** (all bits are read and write functional)

Bit	@Pup	Name	Description
7	0		N7, MSB
6	0		N6
5	0		N5
4	0		N4
3	0		N3
2	0		N2
1	0		N3
0	0		N0, LSB

**Byte 9: Dial-a-Frequency Control Register R** (all bits are read and write functional)

Bit	@Pup	Name	Description
7	0		R6 MSB
6	0		R5
5	0		R4
4	0		R3
3	0		R2
2	0		R1
1	0		R0, LSB
0	0		R and N register load gate 0 = gate closed (data is latched), 1 = gate open (data is loading from SMBus registers into R and N)

**Dial-a-Frequency Feature**

SMBus Dial-a-Frequency feature is available in this device via Byte8 and Byte9. See our App Note AN-0025 for details on our Dial-a-Frequency feature.

P is a large value PLL constant that depends on the frequency selection achieved through the hardware selectors (S1, S0). P value may be determined from *Table 3*.

**Table 3. P Value**

S(1:0)	P
0 0	32005333
0 1	48008000
1 0	96016000
1 1	64010667

**Dial-a-dB Features**

SMBus Dial-a-dB feature is available in this device via Byte8 and Byte9.

**Spread Spectrum Clock Generation (SSCG)**

Spread Spectrum is a modulation technique used to minimizing EMI radiation generated by repetitive digital signals. A clock presents the greatest EMI energy at the center frequency it is generating. Spread Spectrum distributes this energy over a specific and controlled frequency bandwidth therefore causing the average energy at any one point in this band to decrease in value. This technique is achieved by modulating the clock away from its resting frequency by a certain percentage (which also determines the amount of EMI reduction). In this device, Spread Spectrum is enabled by setting specific register bits in the SMBus control Bytes. *Table 4* is a listing of the modes and percentages of Spread Spectrum modulation that this device incorporates.

**Table 4. Spread Spectrum**

SS2	SS1	SS0	Spread Mode	Spread%
0	0	0	Down	+0.00, -0.25
0	0	1	Down	+0.00, -0.50
0	1	0	Down	+0.00, -0.75
0	1	1	Down	+0.00, -1.00
1	0	0	Center	+0.13, -0.13
1	0	1	Center	+0.25, -0.25
1	1	0	Center	+0.37, -0.37
1	1	1	Center	+0.50, -1.50

## Special Functions

### PCIF and IOAPIC Clock Outputs

The PCIF clock outputs are intended to be used, if required, for systems IOAPIC clock functionality. ANY two of the PCIF clock outputs can be used as IOAPIC 33-MHz clock outputs. They are 3.3V outputs will be divided down via a simple resistive voltage divider to meet specific system IOAPIC clock voltage requirements. In the event these clocks are not required, then these clocks can be used as general PCI clocks or disabled via the assertion of the PCI\_STP# pin.

### 3V66\_1/VCH Clock Output

The 3V66\_1/VCH pin has a dual functionality that is selectable via SMBus.

### Configured as DRCG (66M), SMBus Byte0, Bit 5 = '0'

The default condition for this pin is to power up in a 66M operation. In 66M operation this output is SSCG capable and when spreading is turned on, this clock will be modulated.

### Configured as VCH (48M), SMBus Byte0, Bit 5 = '1'

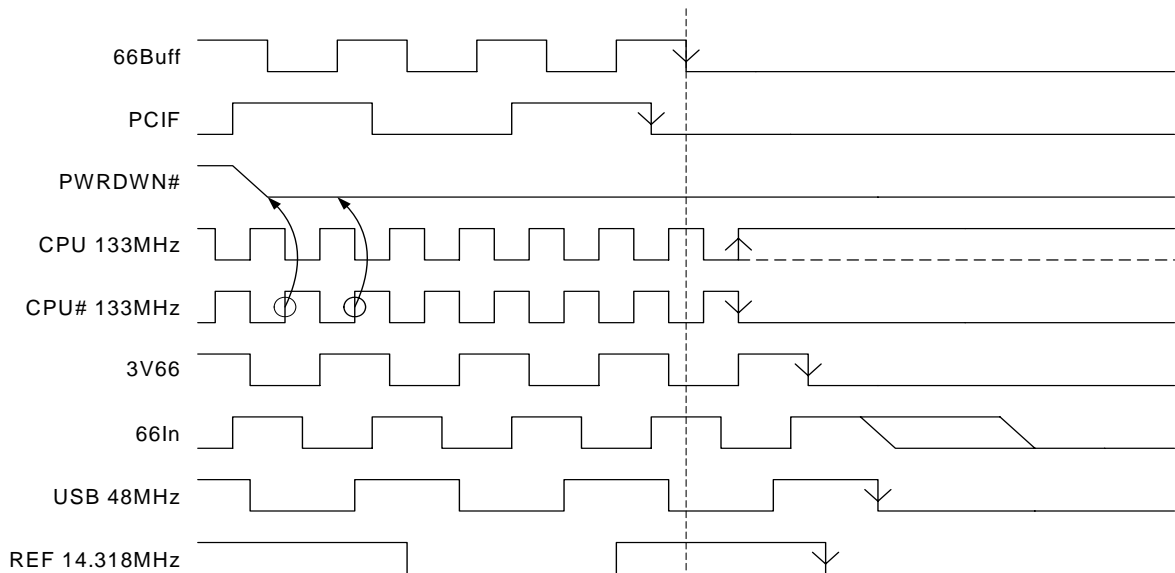
In this mode, the output is configured as a 48-MHz non-spread spectrum output. This output is phase aligned with the other 48M outputs (USB and DOT), to within 1 ns pin-to-pin skew. The switching of 3V66\_1/VCH into VCH mode occurs at system power on. When the SMBus Bit 5 of Byte 0 is programmed from a '0' to a '1', the 3V66\_1/VCH output may glitch while transitioning to 48M output mode.

### PD# (Power-down) Clarification

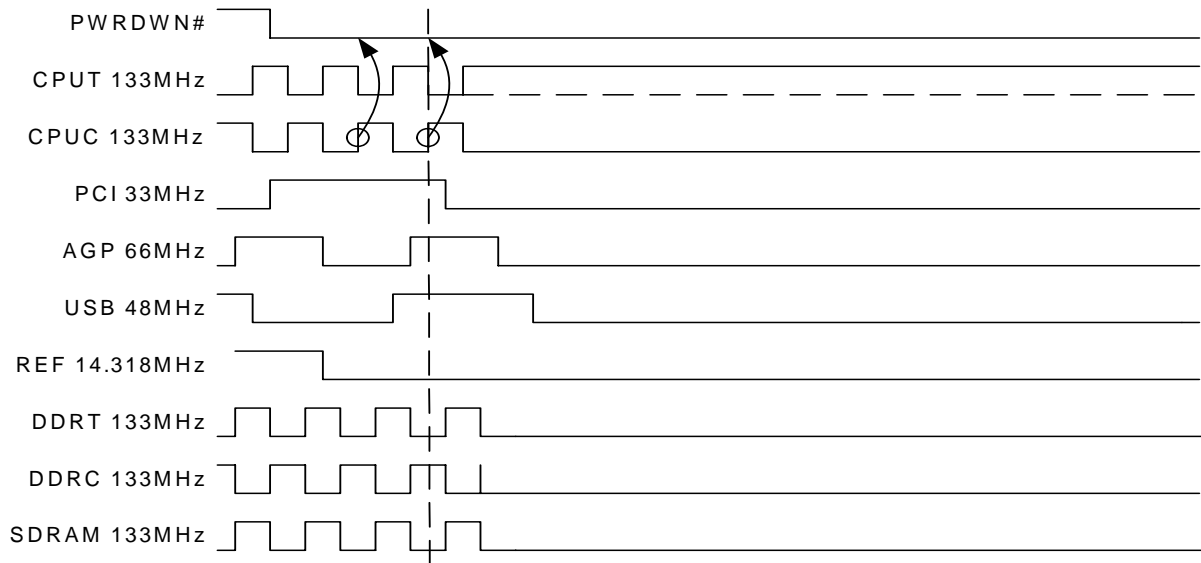
The PD# (Power-down) pin is used to shut off ALL clocks prior to shutting off power to the device. PD# is an asynchronous active LOW input. This signal is synchronized internally to the device powering down the clock synthesizer. PD# is an asynchronous function for powering up the system. When PD# is low, all clocks are driven to a LOW value and held there and the VCO and PLLs are also powered down. All clocks are shut down in a synchronous manner so has not to cause glitches while transitioning to the low 'stopped' state.

### PD#—Assertion

When PD# is sampled LOW by two consecutive rising edges of the CPUC clock, then on the next HIGH-to-LOW transition of PCIF, the PCIF clock is stopped LOW. On the next HIGH-to-LOW transition of 66Buff, the 66Buff clock is stopped LOW. From this time, each clock will stop LOW on its next HIGH-to-LOW transition, except the CPUC clock. The CPU clocks are held with the CPUC clock pin driven HIGH with a value of 2 x Iref, and CPUC undriven. After the last clock has stopped, the rest of the generator will be shut down.


**Figure 1. Power-down Assertion Timing Waveforms—Buffered Mode**

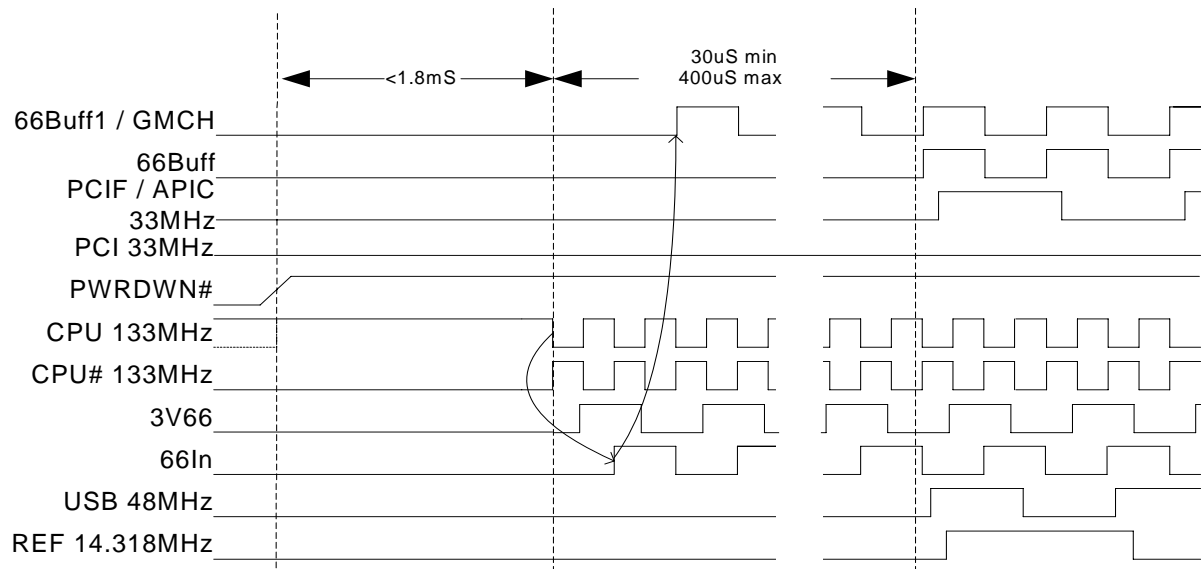




**Figure 2. Power-down Assertion Timing Waveforms—Unbuffered Mode**

### PD# Deassertion

The power-up latency between PD# rising to a valid logic '1' level and the starting of all clocks is less than 3.0 ms.



**Figure 3. Power-down Deassertion Timing Waveforms**

**Table 5. PD# Functionality**

PD#	DRCG	66CLK (0:2)	PCIF/PCI	PCI	USB/DOT
1	66M	66Input	66Input/2	66Input/2	48M
0	Low	Low	Low	Low	Low



**CPU\_STP# Clarification**

The CPU\_STP# signal is an active LOW input used for synchronous stopping and starting the CPU output clocks while the rest of the clock generator continues to function.

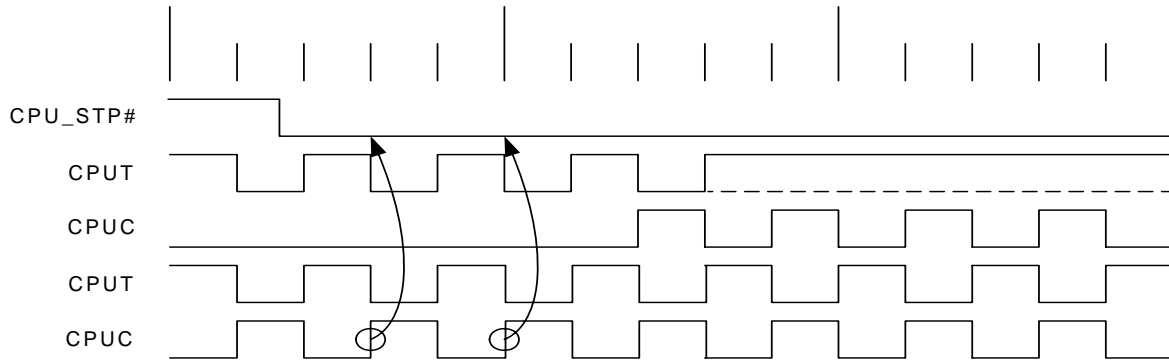
**CPU\_STP# Assertion**

When CPU\_STP# pin is asserted, all CPUT/C outputs that are set with the SMBus configuration to be stoppable via assertion of CPU\_STP# will be stopped after being sampled by two falling CPUT/C clock edges. The final state of the stopped CPU signals is CPUT = HIGH and CPU0C = LOW. There is no change to the output drive current values during the stopped state. The CPUT is driven HIGH with a current value equal to

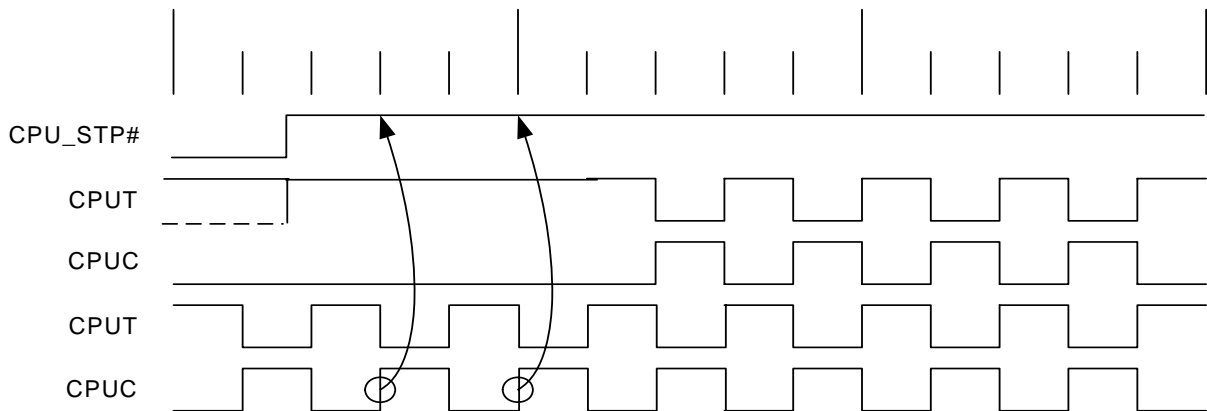
(Mult 0 'select') x (Iref), and the CPUC signal will not be driven. Due to external pull-down circuitry CPUC will be LOW during this stopped state.

**CPU\_STP# Deassertion**

The deassertion of the CPU\_STP# signal will cause all CPUT/C outputs that were stopped to resume normal operation in a synchronous manner. Synchronous manner meaning that no short or stretched clock pulses will be produced when the clock resumes. The maximum latency from the deassertion to active outputs is no more than two CPUC clock cycles.



**Figure 4. CPU\_STP# Assertion Waveforms**



**Figure 5. CPU\_STP# Deassertion Waveforms**

### Three-state Control of CPU Clocks Clarification

During CPU\_STP# and PD# modes, CPU clock outputs may be set to driven or undriven (three-state) by setting the corresponding SMBus entry in Bit6 of Byte0 and Bit6 of Byte1.

#### PCI\_STP# Assertion

The PCI\_STP# signal is an active LOW input used for synchronous stopping and starting the PCI outputs while the rest of the clock generator continues to function. The set-up time for capturing PCI\_STP# going LOW is 10 ns ( $t_{setup}$ ). (See Figure 2.) The PCIF (0:2) clocks will not be affected by this pin if their control bits in the SMBus register are set to allow them to be free running.

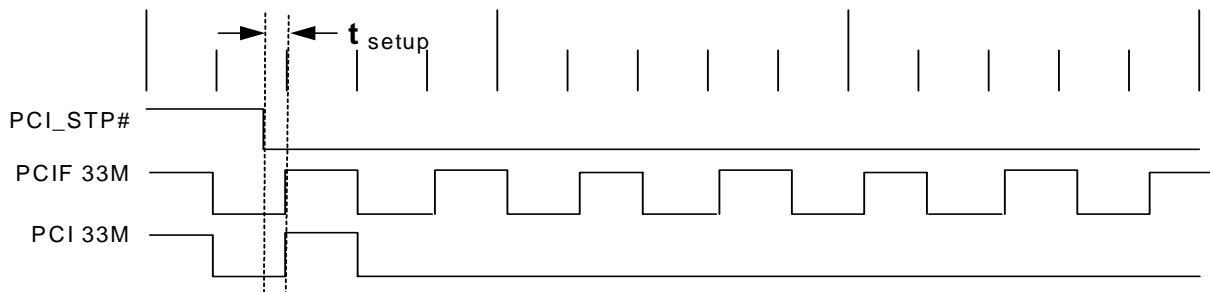
#### PCI\_STP# Deassertion

The deassertion of the PCI\_STP# signal will cause all PCI and stoppable PCIF clocks to resume running in a synchronous manner within two PCI clock periods after PCI\_STP# transitions to a high level.

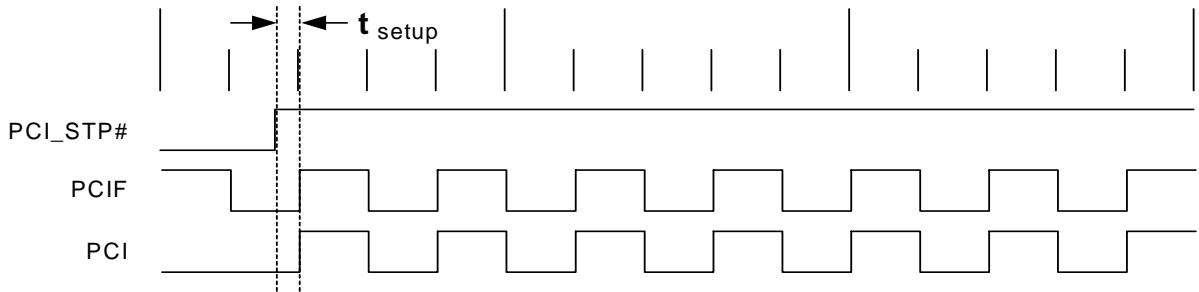
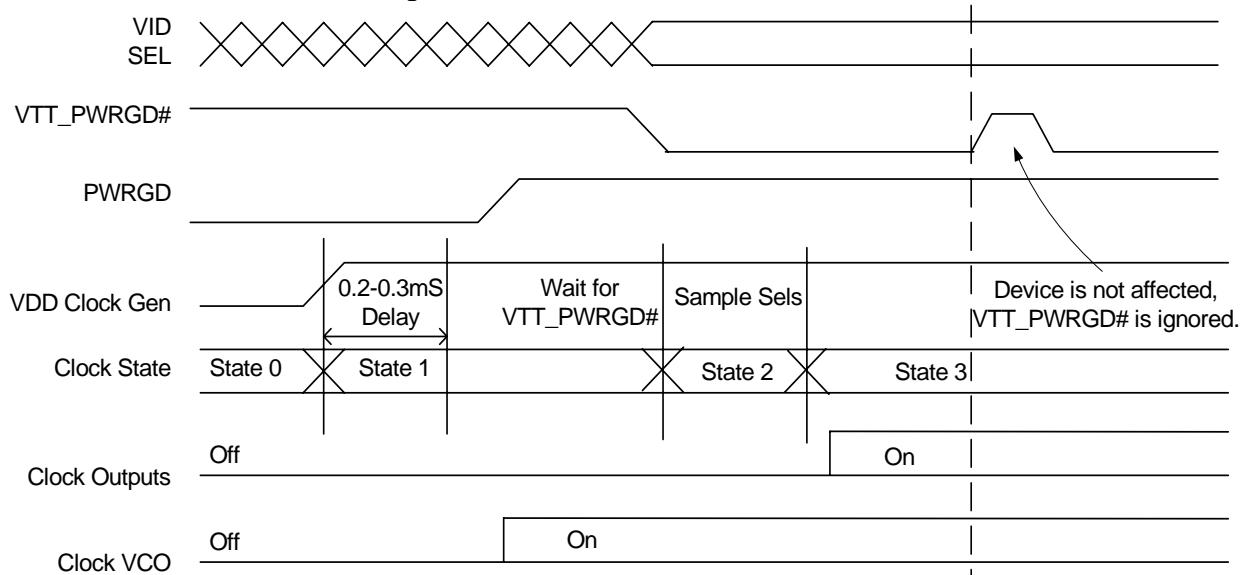
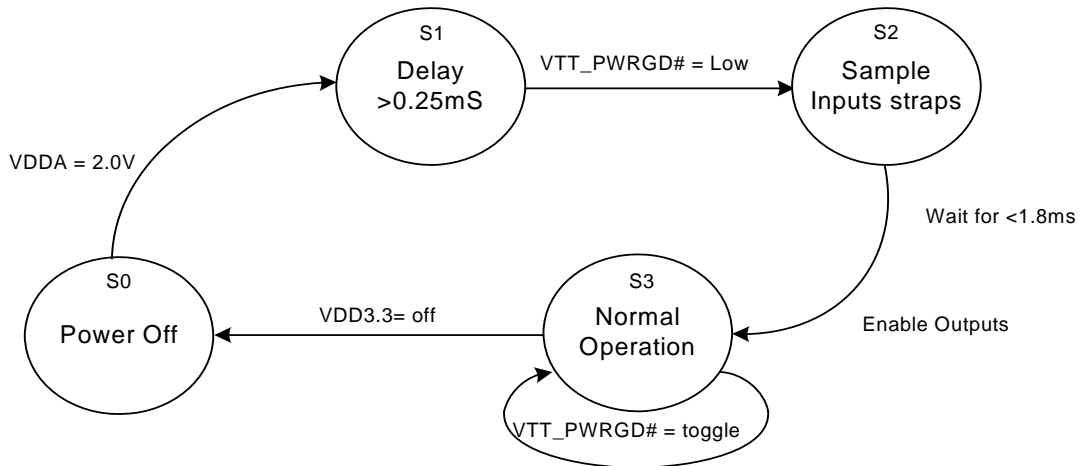
Note that the PCI STOP function is controlled by two inputs. One is the device PCI\_STP# pin number 34 and the other is SMBus byte 0 bit 3. These two inputs to the function are logically ANDed. If either the external pin or the internal SMBus register bit is set low then the stoppable PCI clocks will be stopped in a logic low state. Reading SMBus Byte 0 Bit 3 will return a 0 value if either of these control bits are set LOW thereby indicating the devices stoppable PCI clocks are not running.

**Table 6. Cypress Clock Power Management Truth Table**

B0b6	B1b6	PD#	CPU_STP#	Stoppable CPUT	Stoppable CPUC	Non-Stop CPUT	Non-Stop CPUC
0	0	1	1	Running	Running	Running	Running
0	0	1	0	Iref x6	Iref x6	Running	Running
0	0	0	1	Iref x2	Low	Iref x2	Low
0	0	0	0	Iref x2	Low	Iref x2	Low
0	1	1	1	Running	Running	Running	Running
0	1	1	0	Hi Z	Hi Z	Running	Running
0	1	0	1	Hi Z	Hi Z	Hi Z	Hi Z
0	1	0	0	Hi Z	Hi Z	Hi Z	Hi Z
1	0	1	1	Running	Running	Running	Running
1	0	1	0	Iref x6	Iref x6	Running	Running
1	0	0	1	Hi Z	Hi Z	Hi Z	Hi Z
1	0	0	0	Hi Z	Hi Z	Hi Z	Hi Z
1	1	1	1	Running	Running	Running	Running
1	1	1	0	Hi Z	Hi Z	Running	Running
1	1	0	1	Hi Z	Hi Z	Hi Z	Hi Z
1	1	0	0	Hi Z	Hi Z	Hi Z	Hi Z



**Figure 6. PCI\_STP# Assertion Waveforms**


**Figure 7. PCI\_STP# Deassertion Waveforms**

**Figure 8. VTT\_PWRGD# Timing Diagram**

**Figure 9. Clock Generator Power-up/Run State Program**

Iout is selectable depending on implementation. The parameters above apply to all configurations. Vout is the voltage at the pin of the device.

The various output current configurations are shown in the host swing select functions table. For all configurations, the deviation from the expected output current is  $\pm 7\%$  as shown in the current accuracy table.

**Table 7. Host Clock (HCSL) Buffer Characteristics**

Characteristic	Minimum	Maximum
Ro	3000 Ohms (recommended)	N/A
Ros		
Vout	N/A	1.2V

**Table 8. CPU Clock Current Select Function**

Mult0	Board Target Trace/Term Z	Reference R, Iref – Vdd (3*Rr)	Output Current	Voh @ Z
0	50 Ohms	Rr = 221 1%, Iref = 5.00 mA	Ioh = 4*Iref	1.0V @ 50
1	50 Ohms	Rr = 475 1%, Iref = 2.32 mA	Ioh = 6*Iref	0.7V @ 50

**Table 9. Group Timing Relationship and Tolerances**

Description	Offset	Tolerance	Conditions
3V66 to PCI	2.5 ns	±1.0 ns	3V66 Leads PCI (unbuffered mode)
48M_USB to 48M_DOT Skew	0.0 ns	±1.0 ns	0 degrees phase shift
66B to PCI offset	2.5 ns	±1.0 ns	66B leads PCI (buffered mode)

**Table 10. Maximum Lumped Capacitive Output Loads**

Clock	Max Load	Unit
PCI Clocks	30	pF
3V66	30	pF
66B	30	pF
48M_USB Clock	20	pF
48M_DOT	10	pF
REF Clock	50	pF

### 66IN to 66B Buffered Prop Delay

The 66IN to 66B(0:2) output delay is shown in *Figure 11*.

The Tpd is the prop delay from the input pin (66IN) to the output pins (66B[0:2]). The outputs' variation of Tpd is described in the AC parameters section of this data sheet. The measurement is taken at 1.5V.

### 66B to PCI Buffered Clock Skew

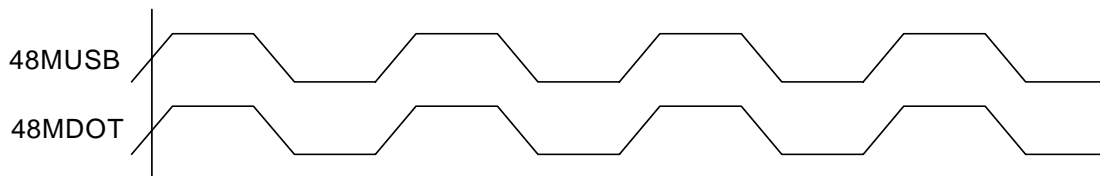
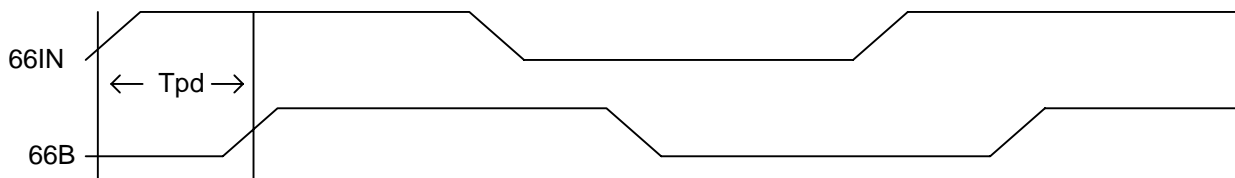
*Figure 12* shows the difference (skew) between the 3V33(0:5) outputs when the 66M clocks are connected to 66IN. This offset is described in the Group Timing Relationship and Tolerances section of this data sheet. The measurements were taken at 1.5V.

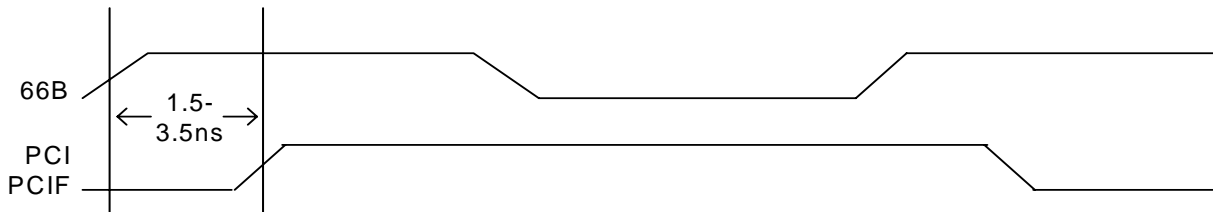
### 3V66 to PCI Unbuffered Clock Skew

*Figure 13* shows the timing relationship between 3V66(0:5) and PCI(0:6) and PCIF when configured to run in the unbuffered mode.

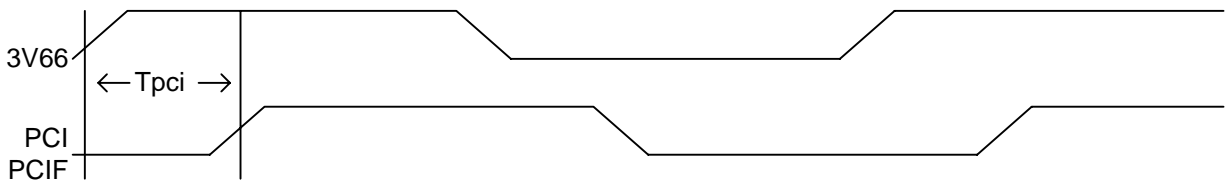
### USB and DOT 48M Phase Relationship

The 48M\_USB and 48M\_DOT clocks are in phase. It is understood that the difference in edge rate will introduce some inherent offset. When 3V66\_1/VCH clock is configured for VCH (48-MHz) operation it is also in phase with the USB and DOT outputs. See *Figure 10*.


**Figure 10. 48M\_USB and 48M\_DOT Phase Relationship**

**Figure 11. 66IN to 66B(0:2) Output Delay Figure**



**Figure 12. Buffer Mode – 33V66(0:1); 66BUF(0:2) Phase Relationship**



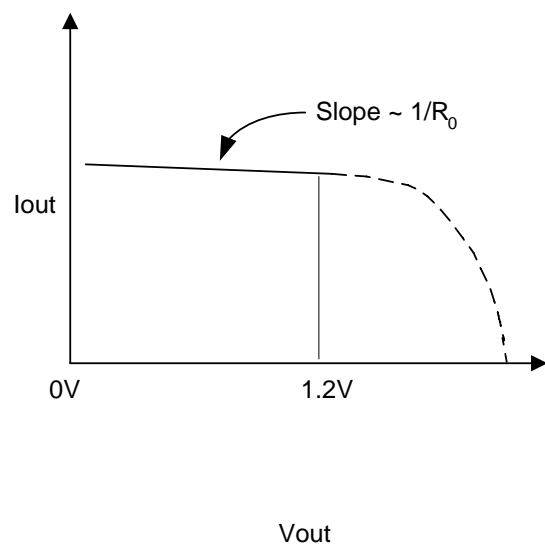
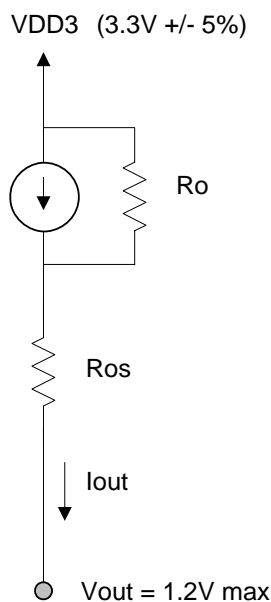
**Figure 13. Unbuffered Mode – 3V66(0:5) to PCI (0:6) and PCIF(0:2) Phase Relationship**

## Buffer Characteristics

### Current Mode CPU Clock Buffer Characteristics

The current mode output buffer detail and current reference circuit details are contained in the previous table of this data sheet. The following parameters are used to specify output buffer characteristics:

1. Output impedance of the current mode buffer circuit –  $R_o$  (see *Figure 14*).
2. Minimum and maximum required voltage operation range of the circuit –  $V_{op}$  (see *Figure 14*).
3. Series resistance in the buffer circuit –  $R_{os}$  (see *Figure 14*).
4. Current accuracy at given configuration into nominal test load for given configuration.



**Figure 14.**

**Absolute Maximum Conditions**

Parameter	Description	Condition	Min.	Max.	Unit
V <sub>DD</sub>	Core Supply Voltage		-0.5	4.6	V
V <sub>DD_A</sub>	Analog Supply Voltage		-0.5	4.6	V
V <sub>IN</sub>	Input Voltage	Relative to V <sub>SS</sub>	-0.5	V <sub>DD</sub> + 0.5	VDC
T <sub>S</sub>	Temperature, Storage	Non-functional	-65	150	°C
T <sub>A</sub>	Temperature, Operating Ambient	Functional	0	85	°C
T <sub>J</sub>	Temperature, Junction	Functional	-	150	°C
∅ <sub>JC</sub>	Dissipation, Junction to Case	Mil-Spec 883E Method 1012.1	-	45	°C/W
∅ <sub>JA</sub>	Dissipation, Junction to Ambient	JEDEC (JESD 51)	-	15	°C/W
ESD <sub>HBM</sub>	ESD Protection (Human Body Model)	MIL-STD-883, Method 3015	2000	-	V
UI-94	Flammability Rating	V-0 @ 1/8 in.	-	10	ppm
MSL	Moisture Sensitivity Level			1	

**DC Parameters** (V<sub>DD</sub> = V<sub>DDA</sub> = 3.3V ±5%)

Parameter	Description	Conditions	Min.	Typ.	Max.	Unit
I <sub>dd3.3V</sub>	Dynamic Supply Current	All frequencies at maximum values <sup>[3]</sup>			280	mA
I <sub>pd3.3V</sub>	Power-down Supply Current	PD# Asserted			Note 4	mA
C <sub>in</sub>	Input Pin Capacitance				5	pF
C <sub>out</sub>	Output Pin Capacitance				6	pF
L <sub>pin</sub>	Pin Inductance				7	nH
C <sub>xtal</sub>	Crystal Pin Capacitance	Measured from the Xin or Xout Pin to Ground.	30	36	42	pF

**AC Parameters** (V<sub>DD</sub> = V<sub>DDA</sub> = 3.3V ±5%)

Parameter	Description	66 MHz		100 MHz		133 MHz		200 MHz		Unit	Notes
		Min.	Max.	Min.	Max.	Min.	Max.	Min.	Max.		
<b>Crystal</b>											
T <sub>dc</sub>	Xin Duty Cycle	47.5	52.5	47.5	52.5	47.5	52.5	47.5	52.5	%	5, 6, 7
T <sub>period</sub>	Xin Period	69.84	71.0	69.84	71.0	69.84	71.0	69.84	71.0	ns	5, 8, 9, 6
V <sub>high</sub>	Xin High Voltage	0.7V <sub>dd</sub>	V <sub>dd</sub>	0.7V <sub>dd</sub>	V <sub>dd</sub>	0.7V <sub>dd</sub>	V <sub>dd</sub>	0.7V <sub>dd</sub>	V <sub>dd</sub>	V	
V <sub>low</sub>	Xin Low Voltage	0	0.3V <sub>dd</sub>	0	0.3V <sub>dd</sub>	0	0.3V <sub>dd</sub>	0	0.3V <sub>dd</sub>	V	
Tr/Tf	Xin Rise and Fall Times		10.0		10.0		10.0		10.0	ns	10
T <sub>ccj</sub>	Xin Cycle to Cycle Jitter		500		500		500		500	ps	8, 11, 6
<b>CPU at 0.7V Timing</b>											
T <sub>dc</sub>	CPUT and CPUC Duty Cycle	45	55	45	55	45	55	45	55	%	11, 12, 13
T <sub>period</sub>	CPUT and CPUC Period	14.85	15.3	9.85	10.2	7.35	7.65	4.85	5.1	ns	11, 12, 13

**Notes:**

- All outputs loaded as per maximum capacitive load table.
- Absolute value = ((Programmed CPU I<sub>ref</sub>) x (2)) + 10 mA.
- This parameter is measured as an average over 1-μs duration, with a crystal center frequency of 14.31818 MHz
- When Xin is driven from an external clock source.
- This is required for the duty cycle on the REF clock out to be as specified. The device will operate reliably with input duty cycles up to 30/70 but the REF clock duty cycle will not be within data sheet specifications.
- All outputs loaded as per *Table 10*.
- Probes are placed on the pins and measurements are acquired at 1.5V for 3.3V signals (see test and measurement set-up section of this data sheet).
- Measured between 0.2V<sub>dd</sub> and 0.7V<sub>dd</sub>.
- This measurement is applicable with Spread ON or Spread OFF.
- Measured at crossing point (V<sub>x</sub>) or where subtraction of CLK-CLK# crosses 0 volts Measured from Vol = 0.175V to Voh = 0.525V.
- Test load is R<sub>ta</sub> = 33.2 ohms, R<sub>d</sub> = 49.9 ohms.

**AC Parameters** ( $V_{DD} = V_{DDA} = 3.3V \pm 5\%$ ) (continued)

Parameter	Description	66 MHz		100 MHz		133 MHz		200 MHz		Unit	Notes
		Min.	Max.	Min.	Max.	Min.	Max.	Min.	Max.		
Tskew	Any CPU to CPU Clock Skew		100		100		100		100	ps	8, 11, 12
Tccj	CPU Cycle to Cycle Jitter		150		150		150		150	ps	11, 12, 13
Tr/Tf	CPUT and CPUC Rise and Fall Times	175	700	175	700	175	700	175	700	ps	11, Notes:, 16
	Rise/Fall Matching		20%		20%		20%		20%		Notes:, 15, 13
DeltaTr	Rise Time Variation		125		125		125		125	ps	Notes:, 13
DeltaTf	Fall Time Variation		125		125		125		125	ps	Notes:, 13
Vcross	Crossing Point Voltage at 0.7V Swing	280	430	280	430	280	430	280	430	mV	11, 13
<b>CPU at 1.0V Timing</b>											
Tdc	CPUT and CPUC Duty Cycle	45	55	45	55	45	55	45	55	%	11, 12
Tperiod	CPUT and CPUC Period	14.85	15.3	9.85	10.2	7.35	7.65	4.85	5.1	nS	11, 12
Tskew	Any CPU to Any CPU Clock Skew		100		100		100		100	pS	8, 11, 12
Tccj	CPU Cycle to Cycle Jitter		150		150		150		150	pS	8, 12
Differential Tr/Tf	CPUT and CPUC Rise and Fall Times	175	467	175	467	175	467	175	467	ps	11, 16
SE-DeltaSlew	Absolute Single-ended Rise/Fall Waveform Symmetry		325		325		325		325	ps	17, 18
Vcross	Cross Point at 1.0V swing	510	760	510	760	510	760	510	760	mV	18
<b>3V66</b>											
Tdc	3V66 Duty Cycle	45	55	45	55	45	55	45	55	%	8, 9
Tperiod	3V66 Period	15.0	15.3	15.0	15.3	15.0	15.3	15.0	15.3	ns	5, 8, 9
Thigh	3V66 High Time	4.95		4.95		4.95		4.95		ns	19
Tlow	3V66 Low Time	4.55		4.55		4.55		4.55		ns	20
Tr / Tf	3V66 Rise and Fall Times	0.5	2.0	0.5	2.0	0.5	2.0	0.5	2.0	ns	21

**Notes:**

14. Measured from  $V_{ol} = 0.175V$  to  $V_{oh} = 0.525V$ .
15. Determined as a fraction of  $2 \cdot (T_{rise} - T_{fall}) / (T_{rise} + T_{fall})$ .
16. Measurement taken from differential waveform, from  $-0.35V$  to  $+0.35V$ .
17. Measurements taken from common mode waveforms, measure rise/fall time from 0.41 to 0.86V. Rise/fall time matching is defined as "the instantaneous difference between maximum clk rise (fall) and minimum clk# fall (rise) time or minimum clk rise (fall) and maximum clk# fall (rise) time". This parameter is designed for waveform symmetry.
18. Measured in absolute voltage, i.e. single-ended measurement.
19. THIGH is measured at 2.4V for non host outputs.
20. TLOW is measured at 0.4V for all outputs.
21. Probes are placed on the pins, and measurements are acquired between 0.4V and 2.4V for 3.3V signals (see test and measurement set-up section of this data sheet).



**AC Parameters** ( $V_{DD} = V_{DDA} = 3.3V \pm 5\%$ ) (continued)

Parameter	Description	66 MHz		100 MHz		133 MHz		200 MHz		Unit	Notes
		Min.	Max.	Min.	Max.	Min.	Max.	Min.	Max.		
Tskew Unbuffered	3V66 to 3V66 Clock Skew		500		500		500		500	ps	8, 9
Tskew Buffered	3V66 to 3V66 Clock Skew		250		250		250		250	ps	8, 9
Tccj	DRCG Cycle to Cycle Jitter		250		250		250		250	ps	8, 9
<b>66B</b>											
Tdc	66B(0:2) Duty Cycle	45	55	45	55	45	55	45	55	%	8, 9
Tr / Tf	66B(0:2) Rise and Fall Times	0.5	2.0	0.5	2.0	0.5	2.0	0.5	2.0	ns	8, 21
Tskew	Any 66B to Any 66B Skew		175		175		175		175	ps	8, 9
Tpd	66IN to 66B(0:2) Propagation Delay	2.5	4.5	2.5	4.5	2.5	4.5	2.5	4.5	ns	8, 9
Tccj	66B(0:2) Cycle to Cycle Jitter		100		100		100		100	ps	8, 9, 22
<b>PCI</b>											
Tdc	PCIF(0:2) PCI (0:6) Duty Cycle	45	55	45	55	45	55	45	55	%	8, 9
Tperiod	PCIF(0:2) PCI (0:6) period	30.0		30.0		30.0		30		nS	5, 8, 9
Thigh	PCIF(0:2) PCI (0:6) high time	12.0		12.0		12.0		12.0		nS	19
Tlow	PCIF(0:2) PCI (0:6) low time	12.0		12.0		12.0		12.0		nS	20
Tr/Tf	PCIF(0:2) PCI (0:6) rise and fall times	0.5	2.0	0.5	2.0	0.5	2.0	0.5	2.0	nS	21
Tskew	Any PCI clock to Any PCI clock Skew		500		500		500		500	pS	8, 9
Tccj	PCIF(0:2) PCI (0:6) Cycle to Cycle Jitter		250		250		250		250	ps	8, 9
<b>48M_USB</b>											
Tdc	48M_USB Duty Cycle	45	55	45	55	45	55	45	55	%	8, 9
Tperiod	48M_USB Period	20.8299	20.8333	20.8299	20.8333	20.8299	20.8333	20.8299	20.8333	ns	8, 9
Tr/Tf	48M_USB Rise and Fall Times	1.0	2.0	1.0	2.0	1.0	2.0	1.0	2.10	ns	8, 21
Tccj	48M_USB Cycle to Cycle Jitter		350		350		350		350	ps	5, 8, 9
<b>48M_DOT</b>											
Tdc	48M_DOT Duty Cycle	45	55	45	55	45	55	45	55	%	8, 9
Tperiod	48M_DOT Period	20.837		20.837		20.837		20.837		ns	8, 9
Tr/Tf	48M_DOT Rise and Fall Times	0.5	1.0	0.5	1.0	0.5	1.0	0.5	1.0	ns	8, 9
Tccj	48M_DOT Cycle to Cycle Jitter		350		350		350		350	ps	8, 9

**Note:**

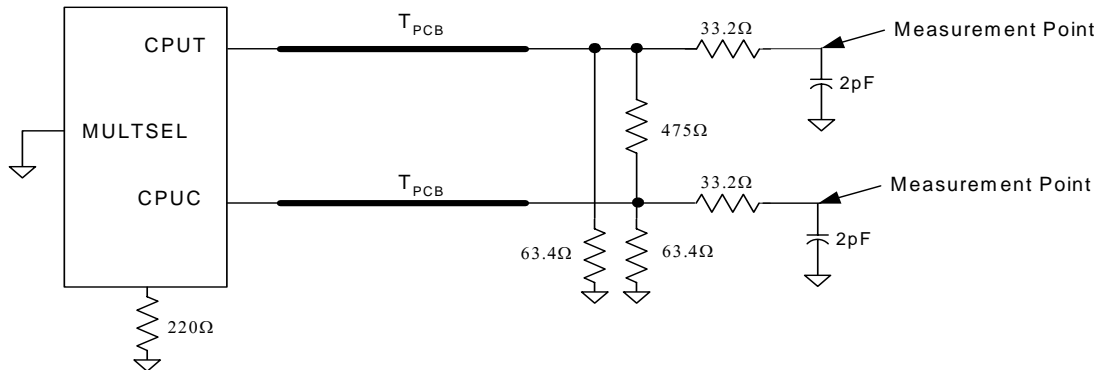
22. This figure is additive to any jitter already present when the 66IN pin is being used as an input. Otherwise a 500-ps jitter figure is specified.

**AC Parameters** ( $V_{DD} = V_{DDA} = 3.3V \pm 5\%$ ) (continued)

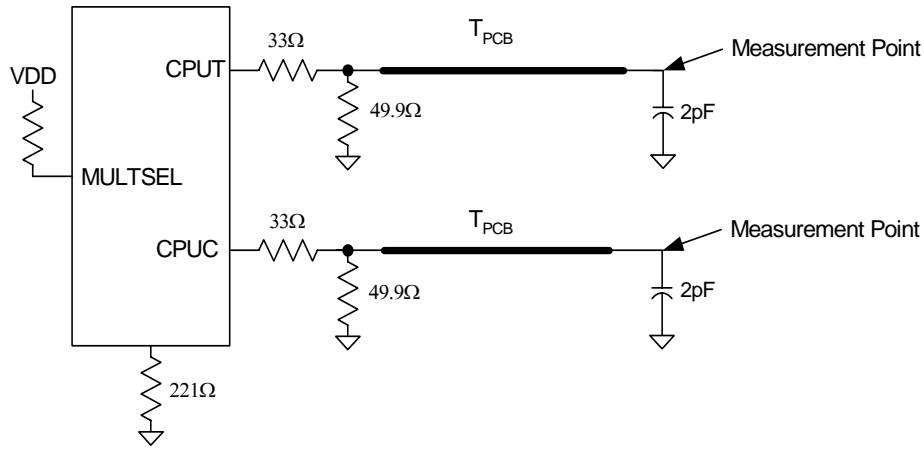
Parameter	Description	66 MHz		100 MHz		133 MHz		200 MHz		Unit	Notes
		Min.	Max.	Min.	Max.	Min.	Max.	Min.	Max.		
<b>REF</b>											
Tdc	REF Duty Cycle	45	55	45	55	45	55	45	55	%	8, 9
Tperiod	REF Period	69.84	71.0	69.84	71.0	69.84	71.0	69.84	71.0	ns	8, 9
Tr / Tf	REF Rise and Fall Times	1.0	4.0	1.0	4.0	1.0	4.0	1.0	4.0	ns	8, 21
Tccj	REF Cycle to Cycle Jitter		1000		1000		1000		1000	ps	8, 9
<b>REF</b>											
Tpzl/Tpzh	Output Enable Delay (all outputs)	1.0	10.0	1.0	10.0	1.0	10.0	1.0	10.0	ns	6
Tplz/Tpzh	Output disable delay (all outputs)	1.0	10.0	1.0	10.0	1.0	10.0	1.0	10.0	ns	6
Tstable	All Clock Stabilization from Power-up		3		3		3		3	ms	6
Tss	Stopclock Set-up Time	10.0		10.0		10.0		10.0		ns	23
Tsh	Stopclock Hold Time	0		0		0		0		ns	23
Tsu	Oscillator Start-up Time		1.2		1.2		1.2		1.2	ms	24

**Test and Measurement Set-up**
**For Differential CPU Output Signals**

The following diagram shows lumped test load configurations for the differential Host Clock Outputs.

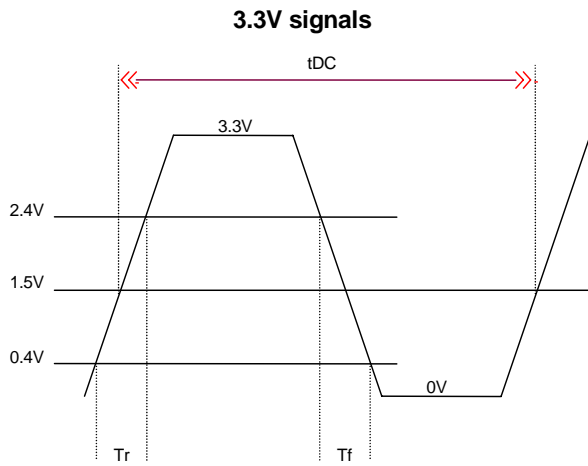
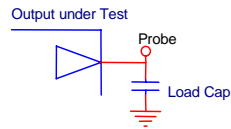

**Figure 15. 1.0V Test Load Termination**
**Notes:**

23. CPU\_STP# and PCI\_STP# setup time with respect to any PCIF clock to guarantee that the effected clock will stop or start at the next PCIF clock's rising edge.  
 24. When Crystal meets minimum 40-ohm device series resistance specification.



**Figure 16. 0.7V Test Load Termination**

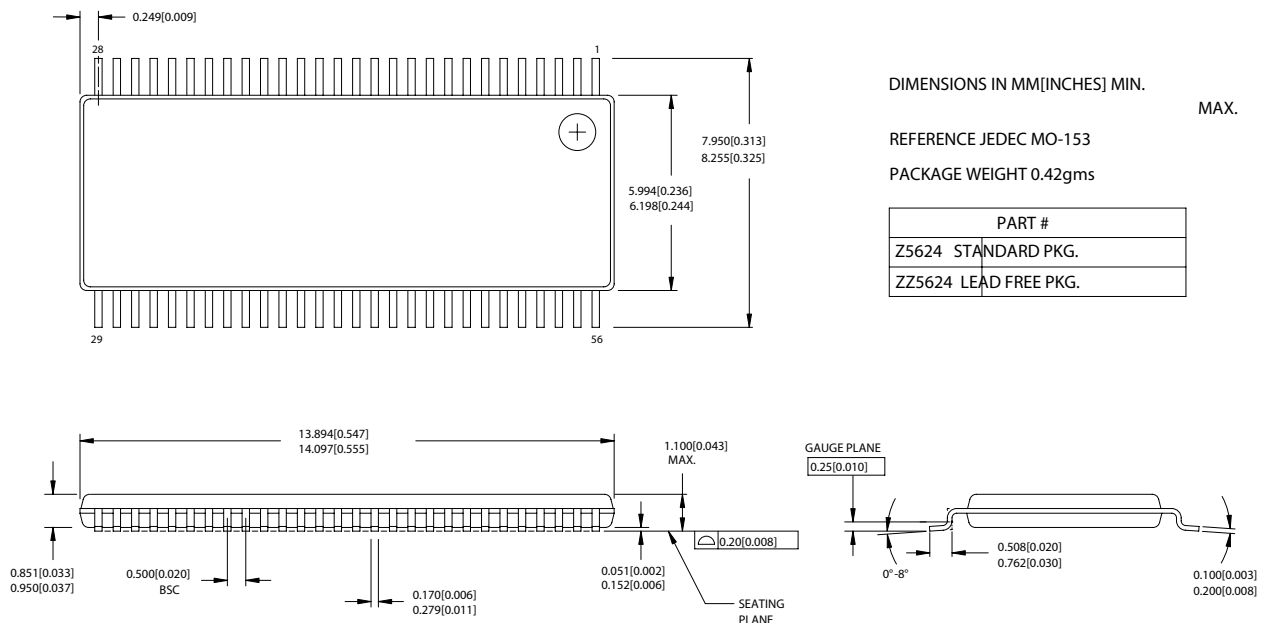
**For Single-Ended Output Signals**



**Figure 17.**

**Ordering Information**

Part Number	Package Type	Product Flow
CY28346ZC-2	56-pin TSSOP–Tube	Commercial, 0° to 70°C
CY28346ZC-2T	56-pin TSSOP–Tape and Reel	Commercial, 0° to 70°C
CY28346ZI-2	56-pin TSSOP–Tube	Industrial, 0° to 85°C
CY28346ZI-2T	56-pin TSSOP–Tape and Reel	Industrial, 0° to 85°C
<b>Lead-free</b>		
CY28346ZXC-2	56-pin TSSOP–Tube	Commercial, 0° to 70°C
CY28346ZXC-2T	56-pin TSSOP–Tape and Reel	Commercial, 0° to 70°C

**Package Drawings and Dimensions**
**56-Lead Thin Shrunk Small Outline Package, Type II (6 mm x 12 mm) Z56**


While SLI has reviewed all information herein for accuracy and reliability, Spectra Linear Inc. assumes no responsibility for the use of any circuitry or for the infringement of any patents or other rights of third parties which would result from each use. This product is intended for use in normal commercial applications and is not warranted nor is it intended for use in life support, critical medical instruments, or any other application requiring extended temperature range, high reliability, or any other extraordinary environmental requirements unless pursuant to additional processing by Spectra Linear Inc., and expressed written agreement by Spectra Linear Inc. Spectra Linear Inc. reserves the right to change any circuitry or specification without notice.