

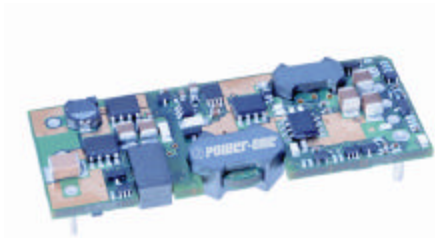

**E2S Series – Eighth-Brick DC/DC Converter**  
**48V Input**  
**5.0V, 3.3V, 2.5V, 2.0V, 1.8V, 1.5V, 1.2V Output**

**Data Sheet**



**Applications**

- Distributed power architectures
- Telecommunications equipment
- LAN/WAN applications
- Data processing applications

**Description**

The new E2S15 series of single-output DC/DC converters, offer unprecedented density and performance in an eighth brick, which is 40% smaller than the traditional quarter-brick footprint. Patent pending technology combined with thermally optimized construction allows the E2S15 to provide 15A of output current in an 8.5mm package without a heatsink. And the E2S15 series requires minimal derating to operating in high ambient temperatures. The 100% surface mount design provides consistent high quality and reliability and the SMT mounting option eliminates the need for separate (additional manual) operations to mount the converters to the motherboards during mass production.

**Features**

- Low profile (<8.5mm)
- 2000 VDC input to output isolation meets basic insulation
- High efficiency
- Start-up into high capacitive load
- Low conducted and radiated EMI
- Output overcurrent protection
- Output overvoltage protection
- Overtemperature protection
- Back drive protection
- Remote sense
- Set point accuracy  $\pm 1\%$
- Remote on/off (primary referenced), positive or negative logic
- Output voltage trim adjust
- UL 1950 Recognized, CSA 22.2 No. 950-95 certified, TUV IEC950

**Selection Chart**

<b>Model</b>	<b>Input Voltage Range, VDC</b>	<b>Input Current, Max, ADC</b>	<b>Output Voltage, VDC</b>	<b>Output Rated Current, I rated ADC</b>	<b>Output Ripple / Noise, Typ, mV p-p</b>	<b>Efficiency @ I rated, Typical, %</b>
E2S15ZY	36-75	0.62	1.2	15	30	81.5
E2S15ZA	36-75	0.77	1.5	15	30	83.5
E2S15ZB	36-75	0.9	1.8	15	30	84.5
E2S15ZC	36-75	1.0	2.0	15	30	85.5
E2S15ZD	36-75	1.2	2.5	15	30	87
E2S15ZE	36-75	1.60	3.3	15	30	88
E2S10ZG	36-75	1.65	5.0	10	30	86



**E2S Series – Eighth-Brick DC/DC Converter**  
**48V Input**  
**5.0V, 3.3V, 2.5V, 2.0V, 1.8V, 1.5V, 1.2V Output**

**Data Sheet**

**Absolute Maximum Ratings**

Stresses in excess of the absolute maximum ratings may cause performance degradation, adversely effect long-term reliability, and cause permanent damage to the converter.

Parameter	Conditions/Description	Min	Max	Units
Input Voltage	Continuous		75	VDC
	100 ms		100	VDC
Operating Temperature	Ambient	-40	85	°C
Storage Temperature		-55	125	°C
ON/OFF Control Voltage	Referenced to -Vin		20	VDC

**Environmental and Mechanical Specifications**

All specifications apply over specified input voltage, output load, and temperature range, unless otherwise noted.

Parameter	Conditions/Description	Min	Nom	Max	Units
Shock	Halfsine wave, 3 axes	50			g
Sinusoidal Vibration	GR-63-Core, Section 5.A.2	1			
Weight			0.53 (15 )		Oz/g
Water Washing	Standard process		Yes		
MTBF	Telcordia TR-332, Method I Case 1		2.6		MHrs

**Isolation Specifications**

All specifications apply over specified input voltage, output load, and temperature range, unless otherwise noted.

Parameter	Conditions/Description	Min	Nom	Max	Units
Insulation Safety Rating		Basic			
Isolation Voltage		2000			VDC
Isolation Resistance		10			MOhm
Isolation Capacitance			160		pF

**Input Specifications**

All specifications apply over specified input voltage, output load, and temperature range, unless otherwise noted.

Parameter	Conditions/Description	Min	Nom	Max	Units
Input Voltage	Continuous	36	48	75	VDC
Turn-On Input Voltage	Ramping Up Vin= 36-75	33		35	VDC
Turn-Off Input Voltage	Ramping Down Vin = 36-75	31		33	VDC
Turn-On Time	To Output Regulation Band 100% Resistive Load		3		ms
Input Reflected Ripple Current	25MHz Bandwidth		6		mA <sub>pk,pk</sub>
Inrush Transient	Vin=Vin.max			0.1	A <sup>2</sup> s



**E2S Series – Eighth-Brick DC/DC Converter**  
**48V Input**  
**5.0V, 3.3V, 2.5V, 2.0V, 1.8V, 1.5V, 1.2V Output**

**Data Sheet**

**Output Specifications**

All specifications apply over specified input voltage, output load and temperature range, unless otherwise noted.

Parameter	Conditions/Description	Min	Nom	Max	Units
Output Voltage Setpoint Accuracy	Vin=Vin.nom, Full Load	-1		1	%Vout
Output Current		0		15	ADC
Line Regulation	Vin.min to Vin.max, Iout.max		+/- 2	+/- 5	mV
Load Regulation	Vin=Vnom, Iout.min to Iout.max		+/- 2	+/- 5	mV
Total output voltage regulation	Over all input voltage, load, and temperature conditions	-3		3	%Vout
Remote Sense Headroom***				10%	%Vout
Dynamic Regulation Peak Deviation Settling Time	50-75% load step change di/dt = 5 A/μs to 1% error band		140 100		mV μs
Admissible Load Capacitance	Iout.max, Nom Vin			15,000	μF
Output Current Limit Threshold**	Vout=0.97Vout.nom	16.5		20	Adc
Switching Frequency			435		kHz
Over voltage Protection, Non Latching	Over all input voltage and load conditions	115	122	127	%Vout
Trim Range	Iout.max, Vin=Vnom	-20		+10	%Vout

\*\* Overcurrent protection is non-latching with auto recovery.

\*\*\* Vout can be increased up to 10% via the sense leads or up to 10% via the trim function, however total output voltage trim from all sources should not exceed 10% of Vout (NOM) in order to insure specified operation of over-voltage protection circuitry.

**Feature Specifications**

All specifications apply over specified input voltage, output load, and temperature range, unless otherwise noted.

Parameter	Conditions/Description	Min	Nom	Max	Units
Shutdown (ON/OFF)					
<b>Negative Logic</b>	On/Off signal is low – converter is ON				
- Converter ON	Low logic range	-20		0.8	VDC
- Converter OFF	High logic range	2.4		20	VDC
<b>Positive Logic</b>	On/Off signal is low –converter is OFF				
- Converter ON	High logic range	2.4		20	VDC
- Converter OFF	Low logic range	-20		0.8	VDC
Overtemperature Protection (PCB)	Shut down		118		°C

### Output Voltage Trim

The trim feature allows the user to adjust the output voltage from the nominal value. This can be used to compensate distribution drops, perform margining in production, or accommodate other requirements when output voltage needs to be adjusted from the nominal.

The converter's output voltage (at the terminals) can be adjusted up 10% or down 20% relative to the nominal output voltage by connecting the TRIM pin to sense (+) or sense (-) via a trim resistor. The Trim pin should be left open if the trimming function is not to be used.

To trim up the output voltage, a trim resistor,  $R_{T-INCR}$ , should be connected between TRIM (Pin 6) and SENSE(+) (Pin 7), as illustrated in Fig. 1. The trim-up resistor can be calculated from:

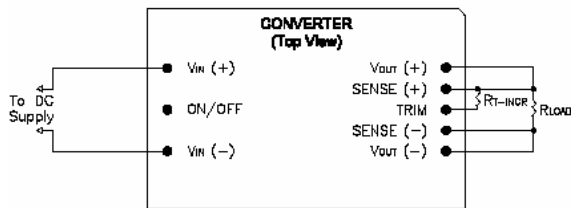

**Figure 1. Output Voltage Trim-up**

$$R_{T-INCR} = \frac{5.1(100+?)V_{O-NOM} - 624.75}{1.225 ?} - 10.2 \text{ [KO]}$$

where,

$R_{T-INCR}$  = Required value of trim-up resistor

$V_{O-NOM}$  = Nominal value of output voltage  
 insert absolute value bars

$$? = \left| \frac{V_{O-REQ} - V_{O-NOM}}{V_{O-NOM}} \right| \times 100 \quad \text{[%]}$$

$V_{O-REQ}$  = Desired (trimmed) output voltage

When trimming up, care must be taken not to exceed the converter's maximum allowable output power.

To trim down the output voltage, a trim resistor,  $R_{T-DECR}$ , should be connected between TRIM (Pin 6) and SENSE(-) (Pin 5), as illustrated in Figure 2.

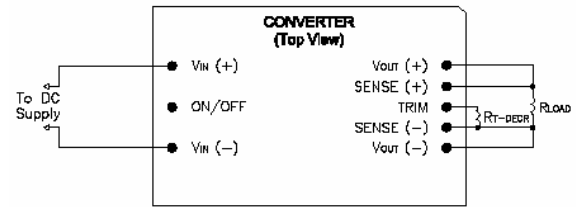

**Figure 2. Output Voltage Trim-down**

The trip-down resistor can be calculated from:

$$R_{T-DECR} = \frac{510}{?} - 10.2 \text{ [KO]}$$

where,

$R_{T-DECR}$  = Required value of trim-down resistor  
 and ? is as defined above.

**Characteristic Curves**

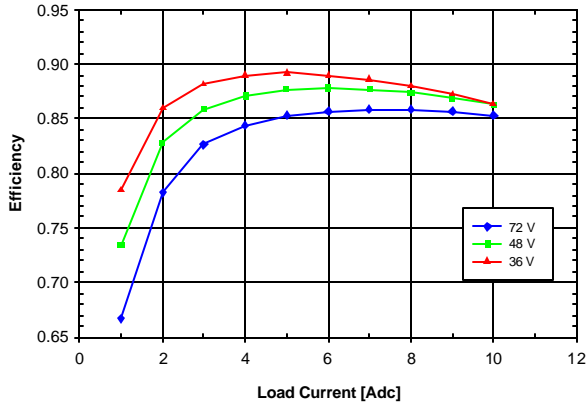

**Figure 3. E2S10ZG (5.0V) Efficiency vs. Load**

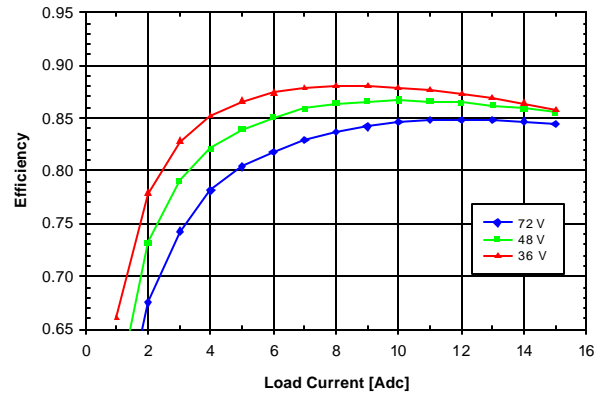

**Figure 6. E2S15ZC (2.0V) Efficiency vs. Load**

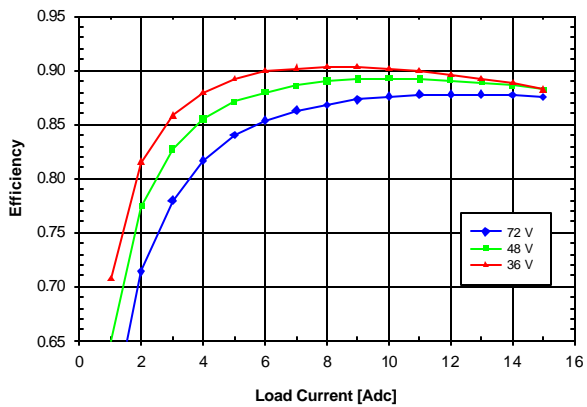

**Figure 4. E2S15ZE (3.3V) Efficiency vs. Load**

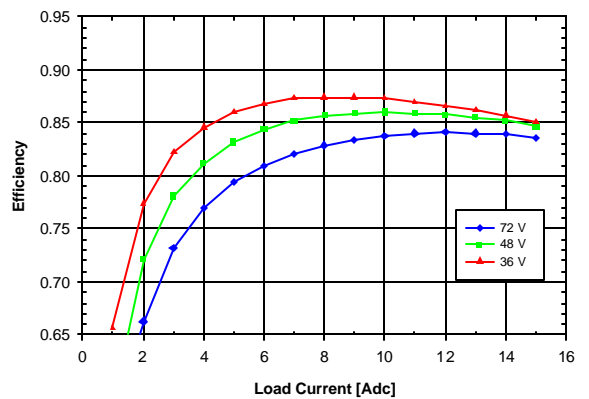

**Figure 7. E2S15ZB (1.8V) Efficiency vs. Load**

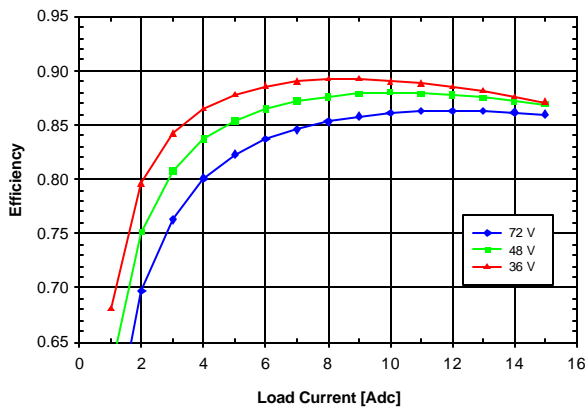

**Figure 5. E2S15ZD (2.5V) Efficiency vs. Load**

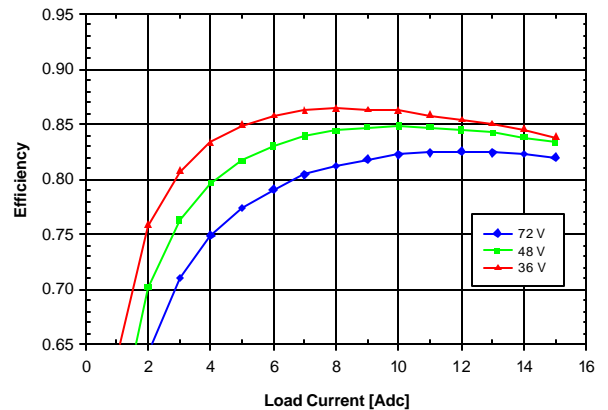

**Figure 8. E2S15ZA (1.5V) Efficiency vs. Load**

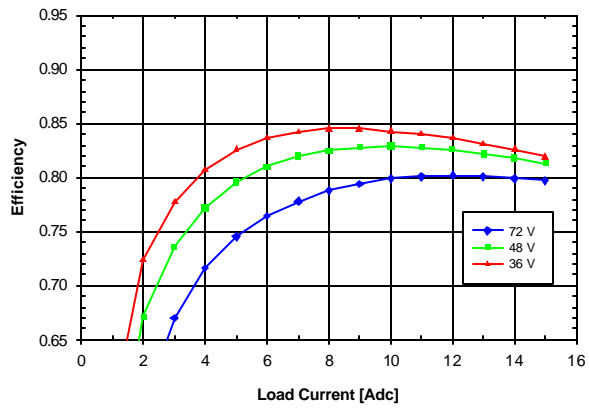

**Figure 9. E2S15ZY (1.2V) Efficiency vs. Load**

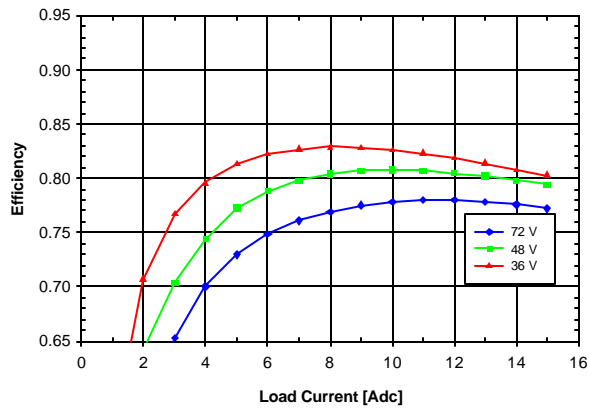
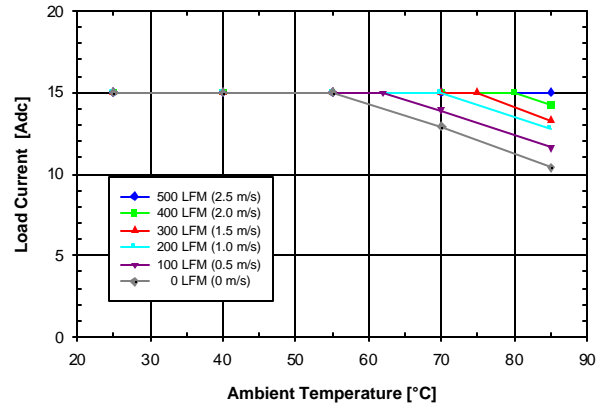

**Figure 10. E2S15ZW (1.0V) Efficiency vs. Load**

**Thermal Considerations**

The E2S15 series converters are designed for natural or forced convection cooling. The maximum allowable output power of the converters is determined by meeting the derating criteria of all electronic components used in the power supplies. An example of the derating criteria for the semiconductor junction temperature is not to exceed 120°C to provide reliable long-term operation of the converters.

The graphs in figures. 11-18 show the maximum output current of the E2S15 series converters at different ambient temperatures under both natural and forced (airflow direction from pin1 to pin3) convection.



**Figure 13. E2S15ZD (2.5V) Derating Curves**

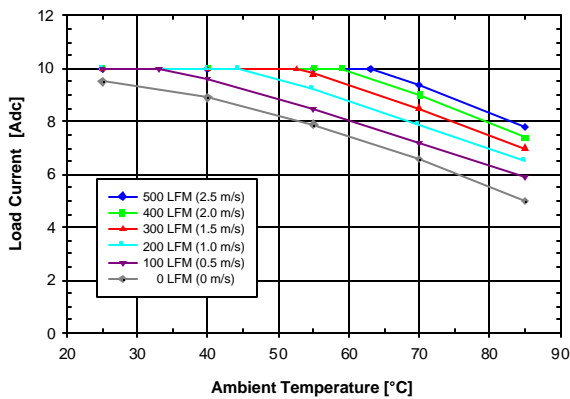

**Figure 11. E2S10ZG (5.0V) Derating Curves**

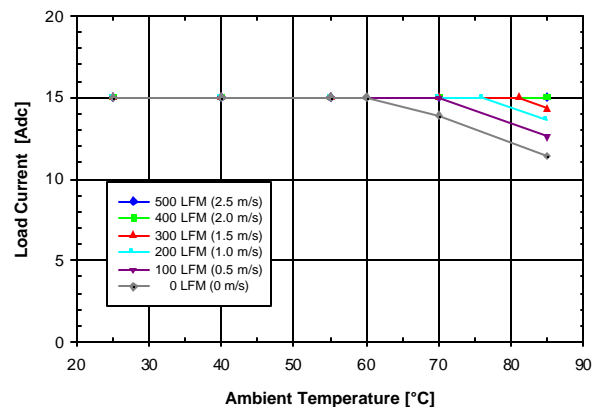

**Figure 14. E2S15ZC (2.0V) Derating Curves**

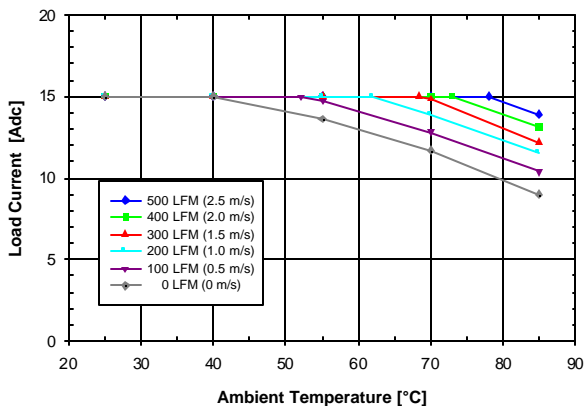

**Figure 12. E2S15ZE (3.3V) Derating Curves**

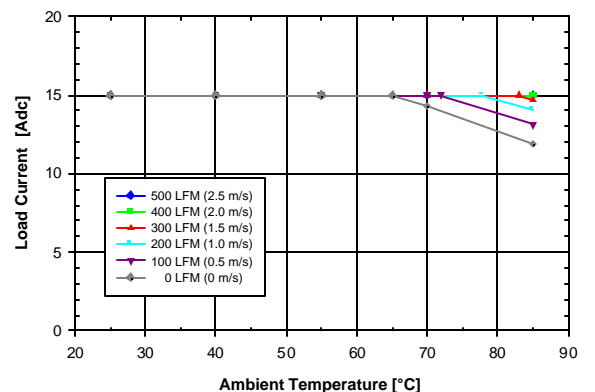

**Figure 15. E2S15ZB (1.8V) Derating Curves**

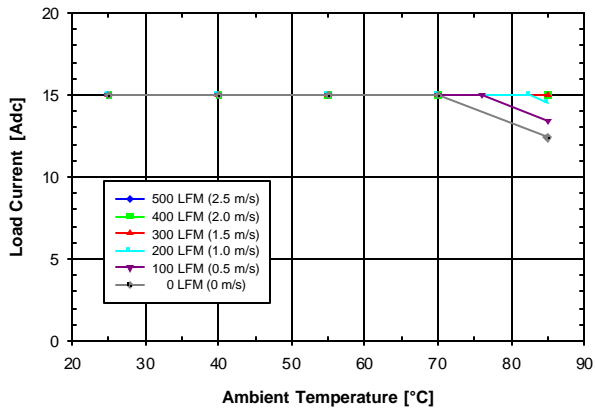

**Figure 16. E2S15ZA (1.5V) Derating Curves**

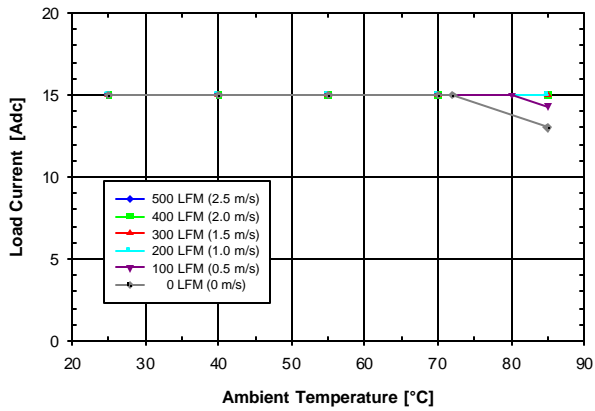

**Figure 17. E2S15ZY (1.2V) Derating Curves**

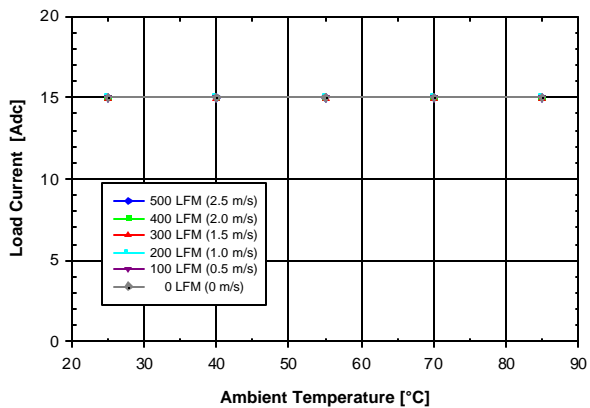
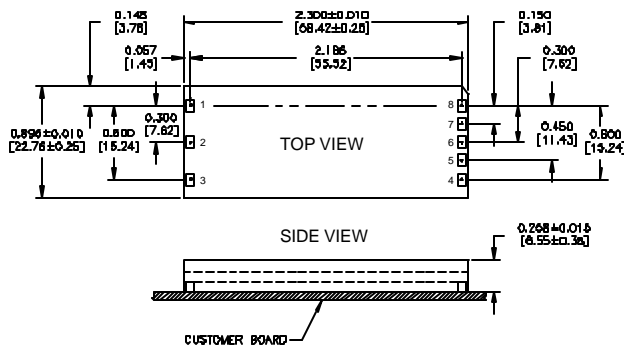

**Figure 18. E2S15ZW (1.0V) Derating Curves**



Min. 0.080" X 0.112" [2.03 x 2.84]  
 Max. 0.092" X 0.124" [2.34 x 3.15]

**MECHANICAL DRAWING Inches (mm)**



**E2S15 Pinout (Surface Mount)**

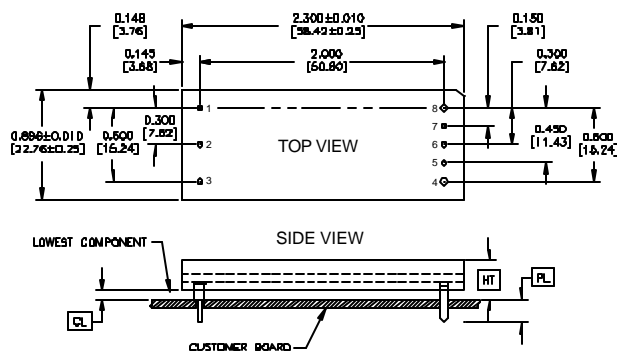

**E2S15 Pinout (Through-hole)**

Pad/Pin Connections	
Pad/Pin #	Function
1	Vin (+)
2	ON/OFF
3	Vin (-)
4	Vout (-)
5	SENSE(-)
6	TRIM
7	SENSE(+)
8	Vout (+)

Height Option	HT (Max. Height) +0.000 [0.00] - 0.038 [-0.97]	CL (Min. Clearance) +0.030 [+0.77] -0.000 [-0.00]
	0.303 [7.69]	0.030 [0.77]
C2	0.336 [8.53]	0.063 [1.60]

**E2S Platform Notes**

- All dimensions are in inches [mm]
- Connector Material: Copper
- Connector Finish: Gold over Nickel
- Converter Weight: 0.53 oz [15 g]
- Recommended Surface-Mount Pads:



**E2S Series – Eighth-Brick DC/DC Converter**  
**48V Input**  
**5.0V, 3.3V, 2.5V, 2.0V, 1.8V, 1.5V, 1.2V Output**

**Data Sheet**

**ORDERING INFORMATION**

Product Series	Output Current	Input Voltage	Output Voltage 1	ON/OFF Logic	Surface Mount	Pin Length	Height Option
<b>E2S</b>	<b>15</b>	<b>Z</b>	<b>G</b>	-	<b>N</b>	<b>M6</b>	<b>C2</b>
Single Output Eighth-Brick Format	Vout1=5 Iout = 10A  Vout1 < 5 Iout=15A	Z = 48Vin Nom.	G = 5.0V E = 3.3V D = 2.5V C = 2.0V B = 1.8V A = 1.5V Y = 1.2V W = 1.0V	N ⇒ Negative  (Blank) ⇒ Positive	M6 ⇒ Surface Mount  (Blank) ⇒ Through Hole	Blank ⇒ 0.188" 7 ⇒ 0.145" 8 ⇒ 0.110"  Not valid w/M6 Option	See Chart Below  Not Valid w/M6 Option

**Height, Clearance and Pin Options for Through Hole Versions**

Height Option	HT (Maximum Height)	CL (Minimum Clearance)	Pin Option	PL (Pin Length)
	+0.000 [+0.00] -0.038 [- 0.97]	+0.030 [+0.77] -0.000 [- 0.00]		±0.005 [±0.13]
blank	0.303 [7.69]	0.030 [ 0.77]		0.188 [4.77]
C2	0.336 [8.53]	0.063 [1.600]		0.145 [3.68]
C3	0.400 [10.16]	0.127 [3.23]		0.110 [2.79]
C4	0.500 [12.70]	0.227 [5.77]		

- Pins 1-3 and 5-7 are f 0.040" (1.02) with f 0.078" (1.98) shoulder
- Pins 4 and 8 are f 0.062" (1.57) without shoulder

**Example: E2S10ZG-NM6 indicates a 5.0V output model with Negative On/Off logic in a SMT mounting package.**

**Notes**

1. Consult factory for the complete list of available options.
2. Power-One products are not authorized for use as critical components in life support systems, equipment used in hazardous environments, or nuclear control systems without the express written consent of the respective divisional president of Power-One, Inc.
3. The appearance of products, including safety agency certifications pictured on labels, may change depending on the date manufactured. Specifications are subject to change without notice.