

Applications

- Distributed power architectures
- Telecommunications equipment
- LAN/WAN applications
- Data processing
- Industrial applications

Features

- RoHS lead free and lead-solder-exempt products are available
- Single board design
- Basic isolation
- Low profile SMT design
- Excellent co-planarity (within 0.1mm)
- Input-to-output isolation: 1500 VDC
- High current density
- Output overcurrent protection
- Operating temperature to 100 °C
- Remote shutdown (primary referenced), negative logic option also available
- Output voltage trim adjust, positive or negative
- 8.5mm height
- UL, CSA, and EN/IEC60950 (3rd ed.) approved

Description

The RDS Series of converters are low profile, single output, DC-DC converters intended for SMT placement and reflow soldering. The product provides onboard conversion of standard telecom and datacom input voltages to isolated low output voltages. Proprietary patented manufacturing processes with full process automation ensure optimal product quality. These are very high performance, cost effective converters with a very small PCB footprint.

Model Selection						
Model	Input Voltage, VDC	Input Current, Max ADC	Output Voltage, VDC	Output Rated Current, ADC	Output Ripple/Noise, mVp-p	Typical Efficiency, %
RDS06ZB-M6	36-75	0.65	1.8	6.0	75	80
RDS05ZE-M6	36-75	0.65	3.3	5.0	75	83
RDS04ZG-M6	36-75	0.65	5.0	4.0	50	87

Model numbers highlighted or shaded are not recommended for new designs.

Absolute Maximum Ratings

Stresses in excess of the absolute maximum ratings may cause performance degradation, adversely affect long term reliability and cause permanent damage to the converter. Specifications apply over specified input voltage, output load and temperature range, unless otherwise noted.

Parameter	Conditions/Description	Min	Max	Units
Input voltage (Vin)	Continuous	36	75	VDC
Transient Input Voltage (Vint)	Transient, 100 ms		100	VDC
Operating CaseTemp. (Tc)	At 100% load	-40	100	°C
Storage Temperature (Ts)		-55	120	°C
ON/OFF Control Voltage (Vrc)	Referenced to -Vin	-1.0	5.5	VDC

Environmental and Mechanical Specifications

Specifications apply over specified input voltage, output load and temperature range, unless otherwise noted.

Parameter	Conditions/Description	Min	Nom	Max	Units
Shock	IEC68-2-27			100	g
Sinusoidal Vibration	IEC68-2-6			10	g
Weight				0.6/17	oz/g
Water Washing	Standard process		Yes		N/A
MTBF	Per Bellcore TR-NWT-000332 (100% load @25°C, GB)		1,452		kHrs

Isolation Specifications

Specifications apply over specified input voltage, output load and temperature range, unless otherwise noted.

Parameter	Conditions/Description	Min	Nom	Max	Units
Insulation Safety Rating	Vin = 36 – 75 VDC		Basic		N/A
Isolation Voltage (Vps)				1,500	VDC
Isolation Resistance (Rps)		10			MOhm
Isolation Capacitance (Cps)	RDS06ZB RDS04ZG, RDS05ZE		4,700 2,200		pF

Input Specifications

Specifications apply over specified input voltage, output load and temperature range, unless otherwise noted.

Parameter	Conditions/Description	Min	Nom	Max	Units
Input Voltage (Vin)	Continuous	36	48	75	VDC
Input Current when Shutdown	Vin.Nom, Remote Control activated		3	10	mADC
Turn-On Input Voltage 36-75 Vin	Ramping Up, Io.Max	32	34	36	VDC
Turn-Off Input Voltage 36-75 Vin	Ramping Down, Io.Max	30	32	34	VDC
Turn-On Time	To Output Regulation Band After Remote Control Rise Time		600 30 5		ms ms ms
Input Reflected Ripple Current	Vin.Max, Io.Max			50	mA _{p-p}
Input Capacitance				1.4	µF

Output Specifications

All specifications apply over input voltage, output load and temperature range, unless otherwise noted.

RDS06ZB : 1.8V/6.0A

Parameter		Conditions/Description	Min	Nom	Max	Units
Output Voltage Setpoint Accuracy	V_o	$V_{in.Nom}$, $I_o = 3.0 A$, 25 °C	1.78	1.8	1.82	VDC
Output Current	I_o	$V_{in.Min}$ to $V_{in.Max}$	0		6.0	ADC
Line Regulation		$V_{in.Min}$ to $V_{in.Max}$, 50% $I_o.Max$			36	mV
Load Regulation		$V_{in.Nom}$, $I_o.Min$ to $I_o.Max$			36	mV
Dynamic Regulation Peak Deviation		50-100% $I_o.Max$ load step change.			150	± mV
Settling Time		to 1% error band			500	µs
Output Voltage Ripple		$V_{in.Min}$ to $V_{in.Max}$, $I_o.Min$ to $I_o Max$, 20 MHz Bandwidth		75	100	mVp-p
Admissible Load Capacitance		$I_o.Max$, $V_{in.Nom}$			2,200	µF
Output Current Limit Threshold		$V_{out} \leq 0.90 V_o.Nom$	120		200	% $I_o.Max$
Switching Frequency		$V_{in.Nom}$, $I_o.Max$		400		kHz
Temperature Coefficient					0.02	% $V_o/^\circ C$
Trim Range		$I_o.Min$ to $I_o.Max$, $V_{in.Min}$ to $V_{in.Max}$	1.62		1.98	VDC

RDS06ZB Typical Characteristic Curves

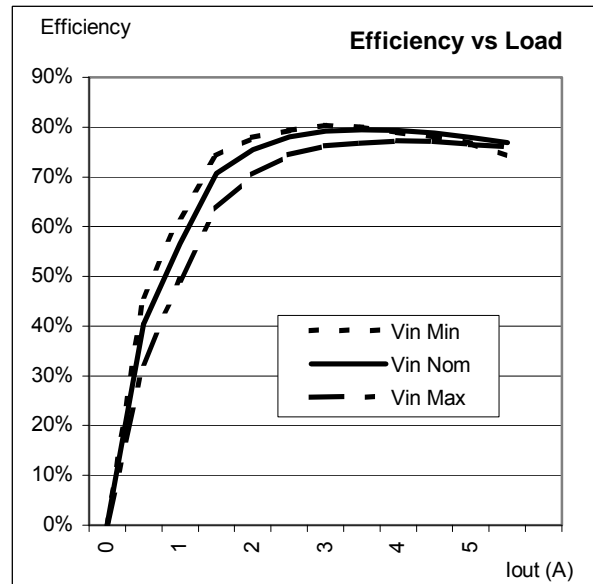
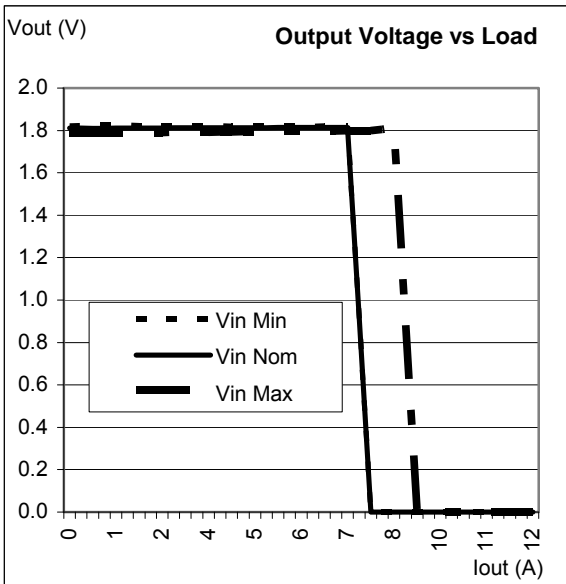

Output Specifications

All specifications apply over input voltage, output load, and temperature range, unless otherwise noted.

RDS05ZE : 3.3V/5A

Parameter		Conditions/Description	Min	Nom	Max	Units
Output Voltage Setpoint Accuracy	V_o	$V_{in.Nom}$, $I_o = 3.0\text{ A}$, $25\text{ }^\circ\text{C}$	3.26	3.3	3.34	VDC
Output Current	I_o	$V_{in.Min}$ to $V_{in.Max}$	0		5.0	ADC
Line Regulation		$V_{in.Min}$ to $V_{in.Max}$, 50% $I_o.Max$			65	mV
Load Regulation		$V_{in.Nom}$, $I_o.Min$ to $I_o.Max$			65	mV
Dynamic Regulation Peak Deviation		50-100% $I_o.Max$ load step change.			150	$\pm\text{ mV}$
Settling Time		to 1% error band			500	μs
Output Voltage Ripple		$V_{in.Min}$ to $V_{in.Max}$, $I_o.Min$ to $I_o.Max$, 20 MHz Bandwidth		75	100	mVp-p
Admissible Load Capacitance		$I_o.Max$, $V_{in.Nom}$			2,200	μF
Output Current Limit Threshold		$V_{out} \leq 0.90 V_{o.Nom}$	120		200	% $I_o.Max$
Switching Frequency		$V_{in.Nom}$, $I_o.Max$		400		kHz
Temperature Coefficient					0.02	% $V_o/^\circ\text{C}$
Trim Range		$I_o.Min$ to $I_o.Max$, $V_{in.Min}$ to $V_{in.Max}$	2.97		3.63	VDC

RDS05ZE Typical Characteristic Curves

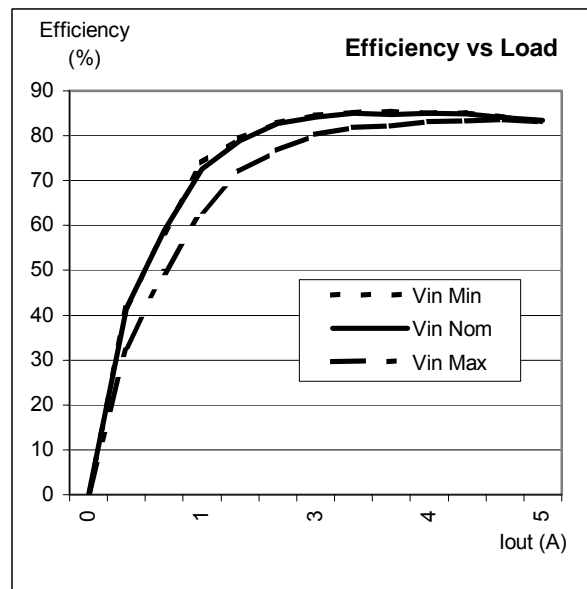
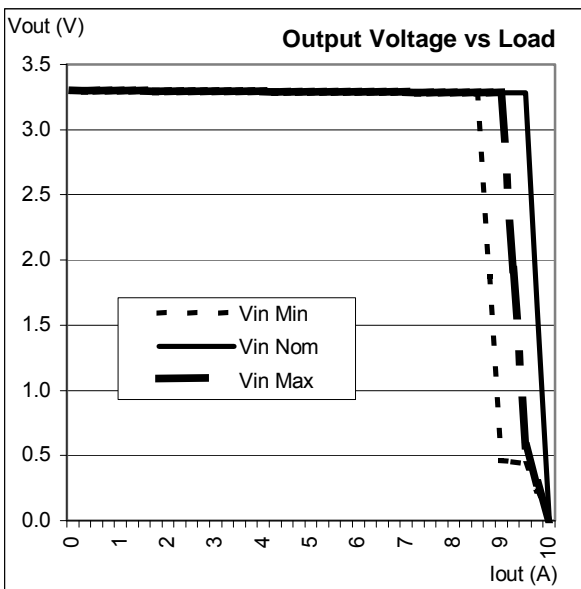

Output Specifications

All specifications apply over input voltage, output load, and temperature range, unless otherwise noted.

RDS04ZG : 5.0V/4.0A

Parameter		Conditions/Description	Min	Nom	Max	Units
Output Voltage Setpoint Accuracy	Vo	Vin.Nom, Io = 2.0 A, 25 °C	4.94	5.0	5.06	VDC
Output Current	Io	Vin.Min to Vin.Max	0		4.0	ADC
Line Regulation		Vin.Min to Vin.Max, 50% Io.Max			120	mV
Load Regulation		Vin.Nom, Io.Min to Io.Max			120	mV
Dynamic Regulation Peak Deviation		50-100% Io.Max load step change.			250	± mV
Settling Time		to 1% error band			500	µs
Output Voltage Ripple		Vin.Min to Vin.Max, Io.Min to Io Max, 20 MHz Bandwidth		50	100	mVp-p
Admissible Load Capacitance		Io.Max, Vin.Nom			2,200	µF
Output Current Limit Threshold		Vout ≤ 0.90 Vo.Nom	120		200	%Io.Max
Switching Frequency		Vin.Nom, Io.Max		400		kHz
Temperature Coefficient					0.02	%Vo/°C
Trim Range		Io.Min to Io.Max, Vin.Min to Vin.Max	4.5		5.5	VDC

RDS04ZG Typical Characteristic Curves

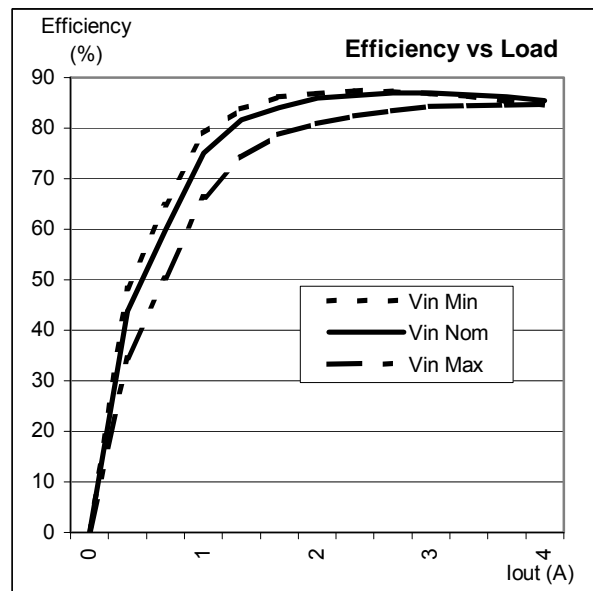
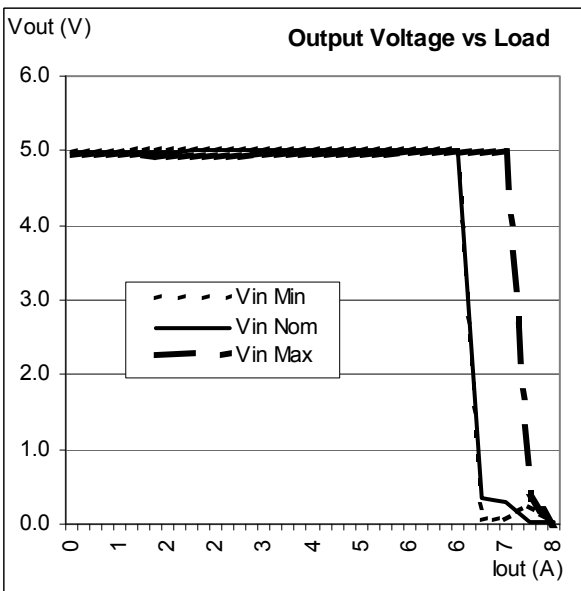

Feature Specifications

All specifications apply over input voltage, output load, and temperature range, unless otherwise noted.

Parameter	Conditions/Description	Min	Nom	Max	Units
Shutdown (ON/OFF)					
POSITIVE LOGIC	On/Off signal is low– converter is OFF				
Converter ON	High logic range	2.5		5.5	VDC
Converter OFF	Shutdown pin is pulled low	-1.0		1.0	VDC
NEGATIVE LOGIC	On/Off signal is low– converter is ON				
Converter ON	Low logic range	-1.0		0.25	VDC
Converter OFF	Shutdown pin is pulled high	1.0		5.5	VDC

Temperature Derating Curves

The derating curves below give an indication of the output power achievable with and without forced-air cooling. However in the final application, in order to ensure the reliability of the unit, care must be taken to ensure the maximum case temperature is not exceeded under any conditions.

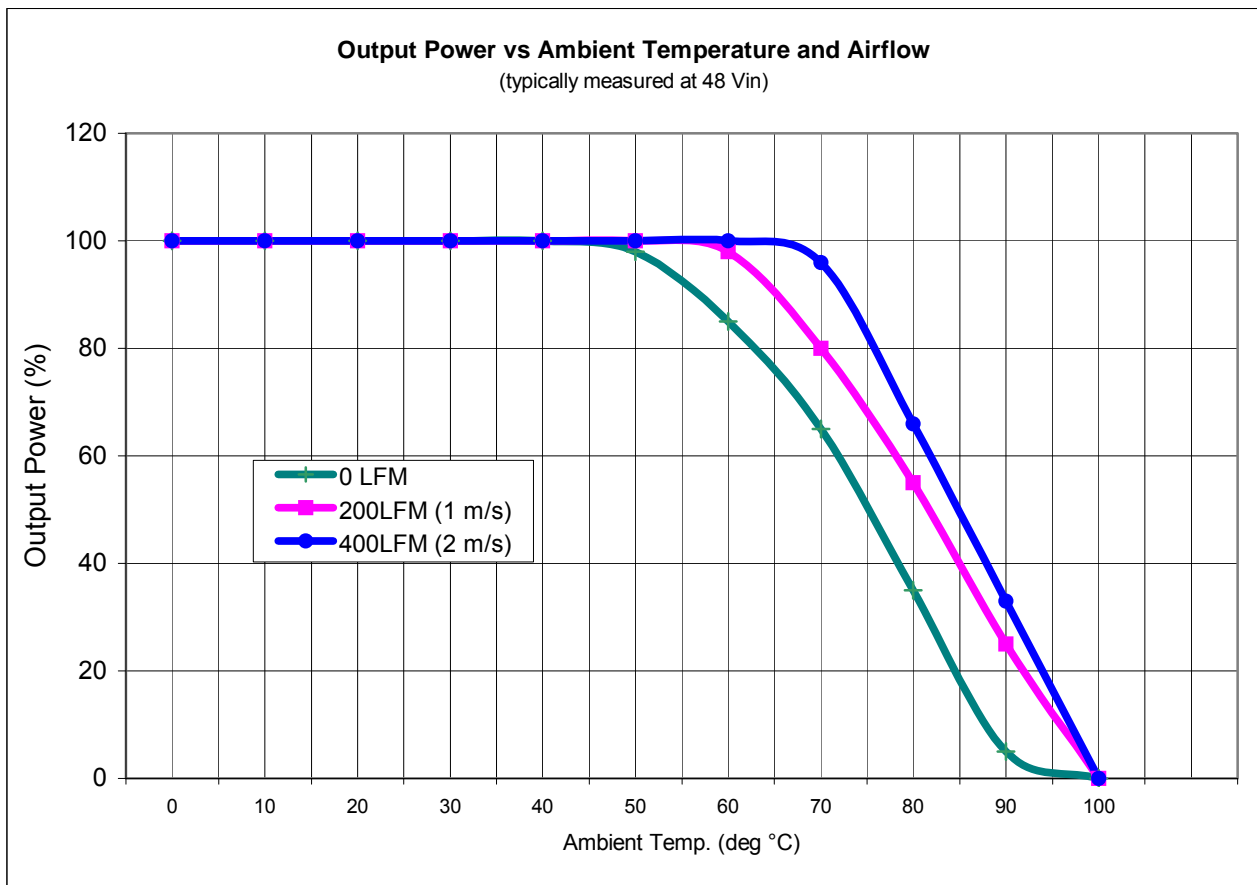

Typical Application

This series of converters does not require any external components for proper operation. However, if the distribution of the input voltage to the converter contains significant inductance, a capacitor across the input terminals may be required to stabilize the input voltage. A minimum of 1µF, quality electrolytic / ceramic capacitor is recommended for this purpose.

For output decoupling it is recommend connecting a 1µF ceramic capacitor directly across the output pins of the converter.

Shutdown Feature

The remote control pin functions as a normal soft shutdown. It is referenced to the -Vin pin. With positive logic, when the remote control pin is pulled low, the output is turned off and the unit goes into a very low input power mode.

An open collector switch is recommended to control the voltage between the shutdown pin and the -Vin pin of the converter. The remote control pin is pulled up internally, so no external voltage source is required. The user should avoid connecting a resistor between the shutdown pin and +Vin pin.

Care must be taken to ensure that the pin reference for the control is connected close to the -Vin pin. The control signal must not be referenced ahead of EMI filtering, or remotely from the unit. If the remote control pin is not used, it can be left floating.

Negative Logic (excludes shut down)

The output of the converter may be enabled or disabled by means of a logic signal (TTL, CMOS, etc.) applied to the shutdown pin. No output voltage overshoot will occur when the unit is turned on. If the function is not required the pin should be connected to -Vin to enable the output .

Thermal Considerations

The converter is designed for natural or forced convection cooling. The output power of the converter is limited by the maximum case temperature (Tc). To ensure reliable long term operation of the converters, and to comply with safety agency requirements, Power-One limits maximum allowable case temperature (Tc) to 100°C (see Mechanical Drawings).

Output Current Limiting

When the output is overloaded above the maximum output current rating, the voltage will start to reduce to maintain the output power to a safe level. In a condition of high overload or short-circuit where the output voltage is pulled below approximately 30% of Vo.Nom, the unit will enter a 'Hiccup' mode of operation. Under this condition the converter will attempt to restart, approximately every 25 ms until the overload has cleared.

Parallel Operation

Paralleling of two converters is not possible.

Output Voltage Trim

The trim feature allows the user to adjust the output voltage from the nominal.

Output voltage can be adjusted using an external resistor. To increase Vo a resistor should be connected between pins 2 and 3. To decrease Vo a resistor should be connected between pins 1 and 3.

To **increase** Vo:

$$R_{ext} = (A - (D \times V_{out})) / (V_{out} - V_{out.Nom}), \Omega$$

To **reduce** Vo:

$$R_{ext} = ((B \times V_{out}) - C) / (V_{out.Nom} - V_{out}), \Omega$$

Where Vout is the desired output voltage

Model	A	B	C	D
RDS06ZB	2590	1730	2560	750
RDS05ZE	7010	3161	7010	1500
RDS04ZG	11260	4532	11240	1500

Note:

When the output voltage is trimmed up, the output power from the converter must not exceed its maximum rating. This is determined by measuring the voltage on the output pins, and multiplying it by the output current.

Safety Considerations

These converters feature 1500 Volt DC isolation from input to output. The input-to-output resistance is greater than 10 MΩ. These converters are provided with Basic Insulation between input and output circuits according to EN60950 / UL1950 / CSA60950-00. Nevertheless, if the system using the converter needs to receive safety agency approval, certain rules must be followed in the design of the system. In particular, all of the creepage and clearance requirements of the end-use safety requirements must be observed. These documents include UL60950, CSA60950-00 and EN60950, although specific applications may have additional requirements.

In order for the output of the converter to be considered as SELV (Safety Extra Low Voltage) or TNV-1, according to EN60950 / UL1950 / CSA60950-00, one of the following requirements must be met in the system design:

- The converter has no internal fuse. An external fuse must be provided to protect the system from catastrophic failure. A fuse with a rating not greater than 2.0 A is recommended. The user can select a lower rating fuse based upon the inrush transient and the maximum input current of the converter, which occurs at the minimum input voltage. Both input traces and the chassis ground trace (if applicable) must be capable of conducting a current of 1.5 times the value of the fuse without opening. The fuse must not be placed in the grounded input line, if any.
- If the voltage source feeding the module is SELV, the output of the converter is considered SELV and may be grounded or ungrounded.
- The circuitry of the converter may generate transients, which exceed the input voltage. Even if the input voltage is SELV (<60V) the components on the primary side of the converter may have to be considered as hazardous. A safety interlock may be needed to prevent the user from accessing the converter while operational.

EMC Specifications

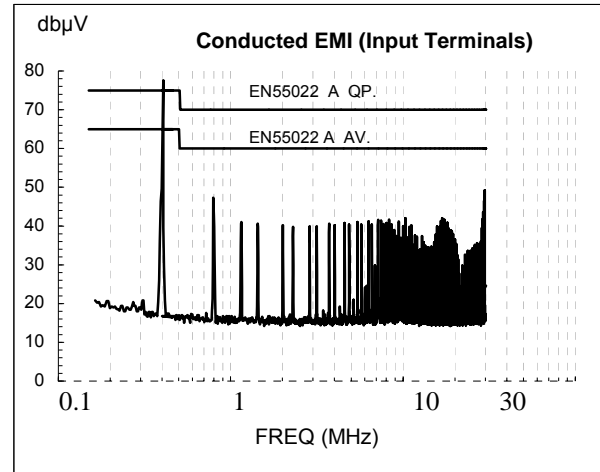

Conducted Noise:

The converters may require a single capacitor to meet the requirements of level A and level B of EN55022, CISPR22 and FCC CFR title 47 Part 15 Sub-part J - Conducted (conducted noise on the input terminals)

Electromagnetic Susceptibility:

Standard	Applied Stress	Class Level	Performance Outcome *
Electrostatic Discharge EN61000-4-2	2 kV to pins	1	B
Electromagnetic Field EN61000-4-3	3V/m	2	A
Electrical Fast Transient EN61000-4-4	2000 Vp to input	3	B
Conducted Disturbances EN61000-4-6	3Vrms to input	2	B

* **A** denotes normal operation, no deviation from specification. **B** denotes temporary deviation from specification is possible.

Surface Mount Assembly

Soldering:

The following instructions must be observed when soldering the unit. Failure to observe these instructions may result in failure or significant degradation of the module performance. Power-One will not honor any warranty claims arising from failure to observe these instructions.

This product is approved for forced convection reflow soldering only.

The curves below define the maximum peak reflow temperature permissible measured on Pins 1 and 10 of the converter.

The lead-frame is constructed from a high temperature glass filled, UL94V0 flame retardant, diallyl ortho-phthalate moulding compound commonly used for packaging of electronics components. It has passed NASA outgassing tests and is certified to MIL-M-14. The coefficient of thermal expansion is equivalent to FR4.

The gull wing leads are formed to ensure optimal solder joint strength and structure. Furthermore they facilitate visual inspection (manual or automatic). The leads are formed from a 97% Cu alloy plated with Cu and Sn 90. This material is commonly used in the manufacture of integrated circuits. It has good corrosion resistance and exhibits the nobility inherent to all high copper alloys. Unlike brasses, this material is essentially immune to stress corrosion cracking. It also exhibits excellent solderability. It is readily wetted by solders and performs well in standard solderability tests. (Dip of Class II or better).

The product is manufactured with a patented process, which is fully automated, and 'in-line'. This ensures that there is no contamination or mechanical stress on the lead-frame so that the co planarity and solderability are maintained.

The product is shipped in JEDEC trays to ensure preservation of the co-planarity and enable fully automated assembly in the final application (within 0.1mm).

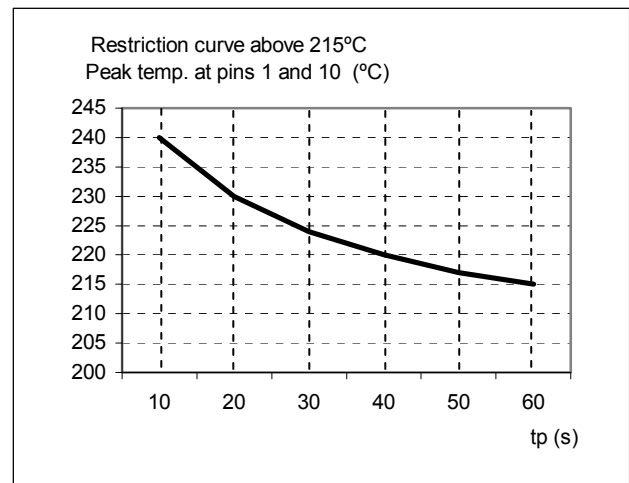
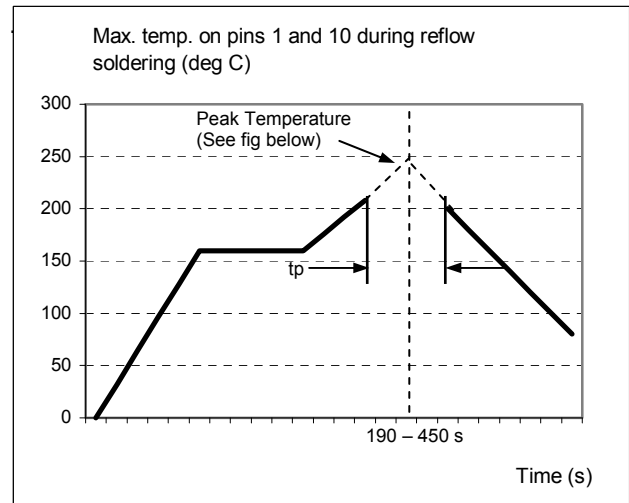

Pick & Place Assembly:

The product is designed with a large flat area in the center of the top surface to serve as a pick up point for automated vacuum pick and place equipment. The 'open board' construction of the unit ensures that weight is kept to a minimum. However due to the relatively large size of the component, a large nozzle (> 8.0mm, depending on vacuum pressure) is recommended for picking and placing.

The unit may also be automatically handled using 'odd-form' placement equipment, with mechanical grippers. For this type of equipment the end edges of the device, which have no leads and also feature the greatest dimensional accuracy, should be used as pick-up points.

Mechanical Drawings

Note:- mm[inches]
Tolerances: -
0.5-10 ±0.1
10-100 ±0.2

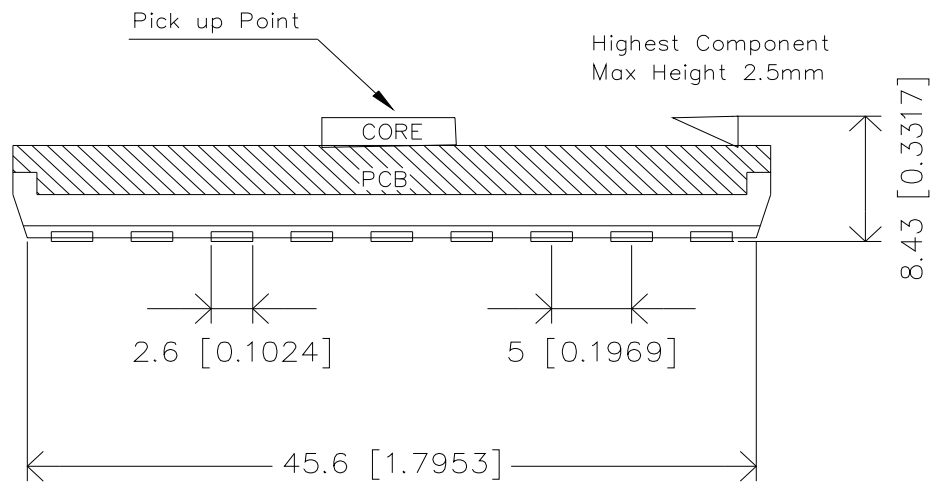
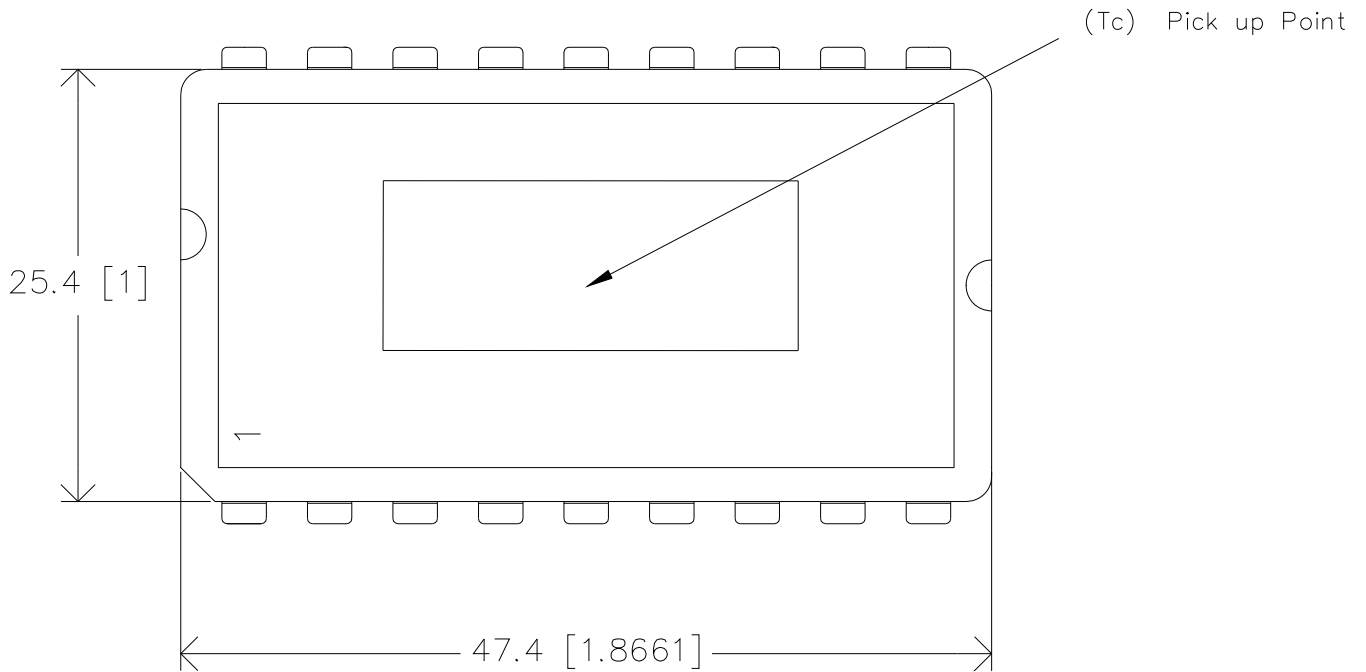

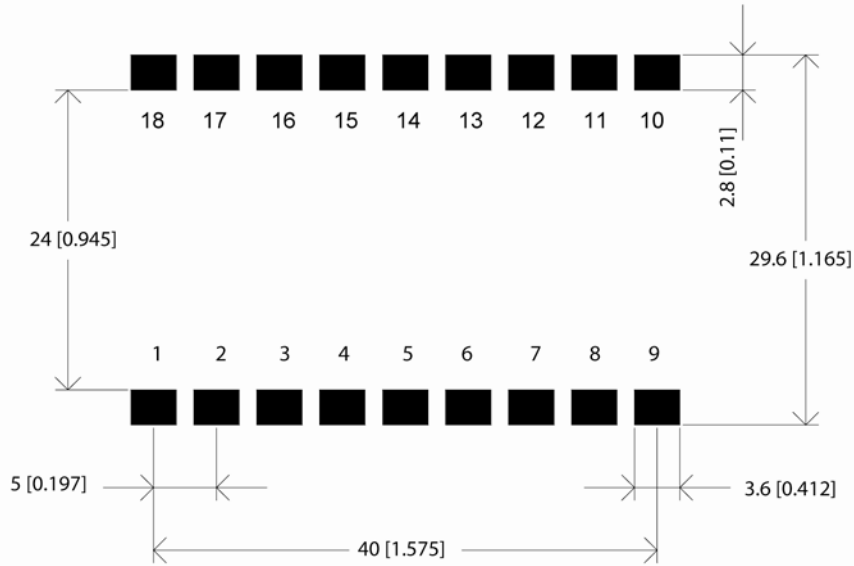

Recommended land pattern

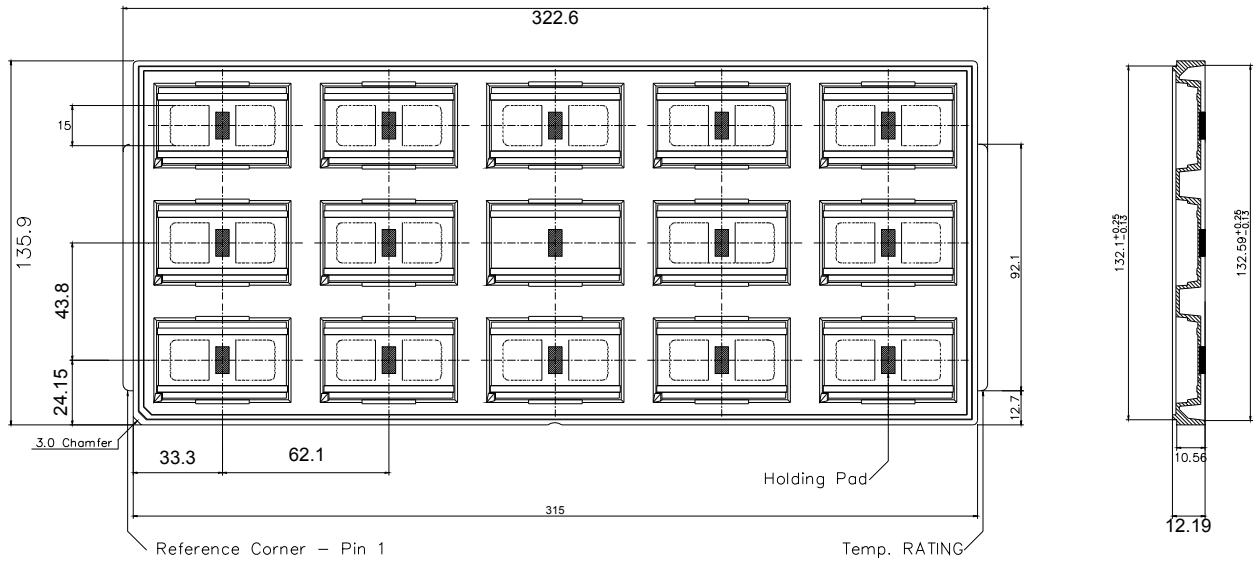

JEDEC TRAY

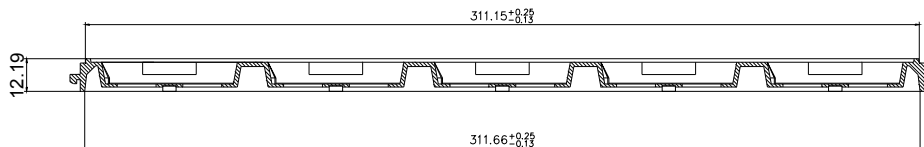

Pinout

Pin	Designation	Function	Reference
1	+Vout	Positive output voltage	Secondary
2	-Vout	Output voltage return	Secondary
3	Trim	Output voltage adjust	Secondary
4	NC	No connection	Secondary
5	NC	No connection	Primary
6	NC	No connection	Primary
7	NC	No connection	Primary
8	NC	No connection	Primary
9	NC	No connection	Primary
10	NC	No connection	Primary
11	Shutdown	Shutdown control. Pull low to turn unit off	Primary
12	NC	No connection	Primary
13	NC	No connection	Primary
14	NC	No connection	Primary
15	NC	No connection	Primary
16	NC	No connection	Primary
17	-Vin	Input voltage return	Primary
18	+Vin	Positive input voltage	Primary

Ordering Information

Options	Suffixes to add to part number
Negative shutdown logic	Add suffix letter "N" before the M6.
RoHS lead-solder exempt compliant ¹	No RoHS suffix character required
RoHS compliant for all six substances	Add "G" as the last character of the part number.

¹ The solder exemption refers to all the restricted materials except lead in solder.

Example:- RDS05ZE-NM6G is a surface mount converter, with negative logic for shutdown, and RoHS compliant for all six substances.

NUCLEAR AND MEDICAL APPLICATIONS - Power-One products are not designed, intended for use in, or authorized for use as critical components in life support systems, equipment used in hazardous environments, or nuclear control systems without the express written consent of the respective divisional president of Power-One, Inc.

TECHNICAL REVISIONS - The appearance of products, including safety agency certifications pictured on labels, may change depending on the date manufactured. Specifications are subject to change without notice.