

X2Y

®



Technology In Balance

X2Y® FILTER & DECOUPLING CAPACITORS

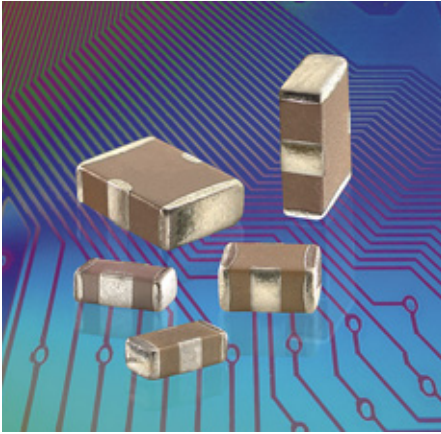

X2Y® filter capacitors employ a unique, patented low inductance design featuring two balanced capacitors that are immune to temperature, voltage and aging performance differences. These components offer superior decoupling and EMI filtering performance, virtually eliminate parasitics, and can replace multiple capacitors and inductors saving board space and reducing assembly costs.

ADVANTAGES

- One device for EMI suppression or decoupling
- Replace up to 7 components with one X2Y
- Differential and common mode attenuation
- Matched capacitance line to ground, both lines
- Low inductance due to cancellation effect

APPLICATIONS

- FPGA / ASIC / μ -P Decoupling
- DDR Memory Decoupling
- Amplifier Filter & Decoupling
- High Speed Data Filtering
- Cellular Handsets

Equivalent Circuits



Cross-sectional View

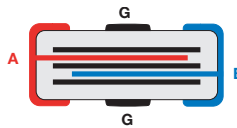

Dimensional View

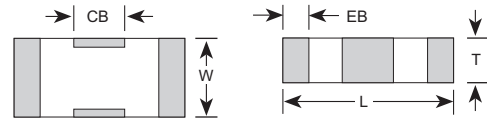

Circuit 1 Capacitance (1 Y-Capacitor)		<10pF	10pF	22pF	27pF	33pF	47pF	100pF	220pF	470pF	1000pF	1500pF	2200pF	4700pF	.010 μ F	.015 μ F	.022 μ F	.047 μ F	0.10 μ F	0.18 μ F	0.22 μ F	0.33 μ F	0.40 μ F	0.47 μ F	1.0 μ F	
Circuit 2 Capacitance (2 Y-Caps in Parallel)		<20pF	20pF	44pF	54pF	66pF	94pF	200pF	440pF	940pF	2000pF	3000pF	4400pF	9400pF	.020 μ F	.030 μ F	.044 μ F	.094 μ F	0.20 μ F	0.36 μ F	0.44 μ F	0.68 μ F	0.80 μ F	0.94 μ F	2.0 μ F	
CASE SIZE EIA (JDI)	CAP. CODE	XRX	100	220	270	330	470	101	221	471	102	152	222	472	103	153	223	473	104	184	224	334	404	474	105	
0402 (X07)	NPO	50	50	50	50	50	50	50																		
	X7R							50	50	50	50	50	50	50	16											
0603 (X14)	NPO	100	100	100	100	100	100	50	50																	
	X7R						100	100	100	100	100	100	100	100	50	25	25	16	10		6.3					
0805 (X15)	NPO		100	100	100	100	100	100	50	50																
	X7R						100	100	100	100	100	100	100	100	100	50	50	50	25	10						
1206 (X18)	NPO										100															
	X7R														100	100	100	100	100		16	16		10		
1210 (X41)	X7R																		100		100	100			16	
1410 (X44)	X7R																						100			
1812 (X43)	X7R																						100	100		

SEE PART NUMBER LISTING TABLE ON PAGES 7 & 8 Contact factory for part combinations not shown.

Circuit 1 capacitance measured Line-to-Ground (A or B to G) Circuit 2 capacitance measured Power-to-Ground (A + B to G)

Rated voltage is from line to ground in Circuit 1, power to ground in Circuit 2.

X2Y® technology patents and registered trademark under license from X2Y ATTENUATORS, LLC



X2Y® FILTER & DECOUPLING CAPACITORS

Filtering Circuit 1 S21 Signal-to-Ground

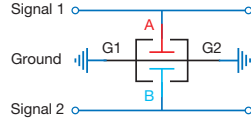

Decoupling Circuit 2 S21 Power-to-Ground

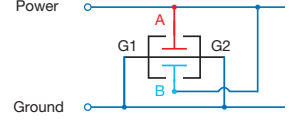

Labeled capacitance values below follow the P/N order code or Y cap value (Circuit 1.)
Effective capacitance measured in Circuit 2 is 200% of the labeled Circuit 1 Y cap value.

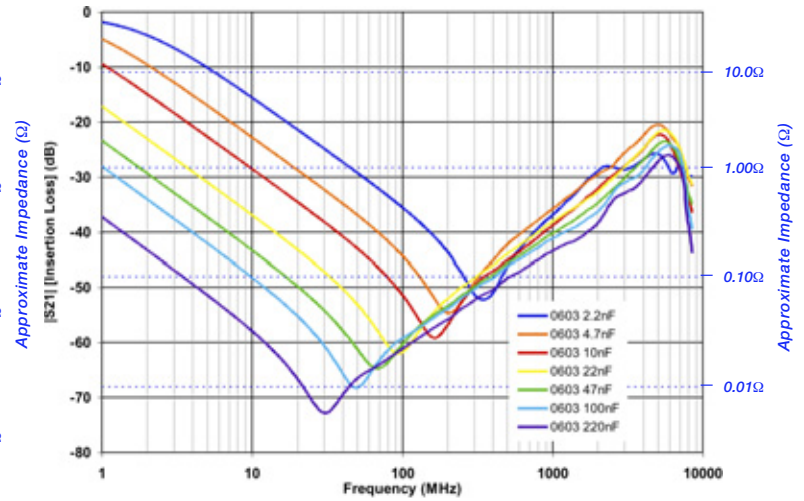
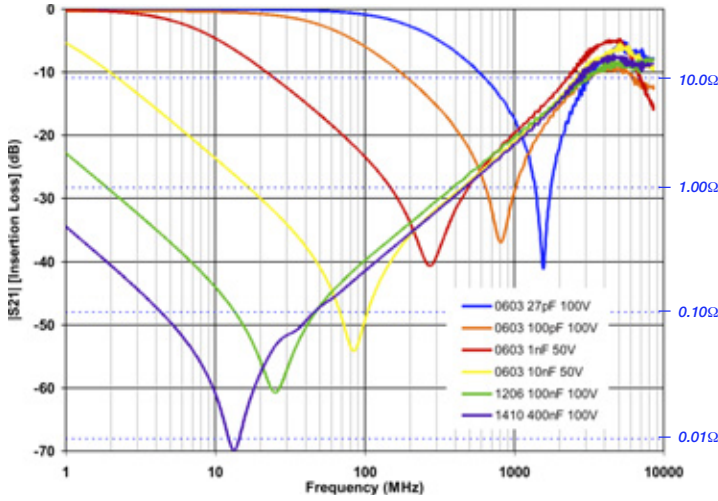

ELECTRICAL CHARACTERISTICS

	NPO	X7R
Temperature Coefficient:	±15% (-55 to +125°C)	±15% (-55 to +125°C)
Dielectric Strength:	2.5 X WVDC, 25°C, 50mA max.	
Dissipation Factor:	0.1% max.	WVDC ≥ 50 VDC: 2.5% max. WVDC = 25 VDC: 3.5% max. WVDC = 10, 16 VDC: 5.0% max. WVDC = 6.3 VDC: 10% max.
Insulation Resistance (Min. @ 25°C, WVDC)	C ≤ 0.047μF: 1000 ΩF or 100 GΩ, whichever is less C > 0.047μF: 500 ΩF or 10 GΩ, whichever is less	
Test Conditions:	C > 100 pF; 1kHz ±50Hz; 1.0±0.2 VRMS C ≤ 100 pF; 1Mhz ±50kHz; 1.0±0.2 VRMS	1.0kHz±50Hz @ 1.0±0.2 Vrms
Other:	See main catalog page 20 for additional dielectric specifications.	

HOW TO ORDER X2Y® FILTER & DECOUPLING CAPACITORS

100	X14	W	104	M	V	4	T
VOLTAGE 6R3 = 6.3 V 100 = 10 V 160 = 16 V 250 = 25 V 500 = 50 V 101 = 100 V	CASE SIZE X07 = 0402 X14 = 0603 X15 = 0805 X18 = 1206 X41 = 1210 X43 = 1812 X44 = 1410	DIELECTRIC N = NPO W = X7R	CAPACITANCE (Circuit 1) 1st two digits are significant; third digit denotes number of zeros. 102 = 1000 pF = 1 nF 103 = 0.01 μF = 10 nF 104 = 0.10 μF = 100 nF	TOLERANCE M = ± 20%	TERMINATION V = Ni barrier w/ 100% Sn Plating	MARKING 4 = Unmarked	TAPE MODIFIER Code Tape Reel E Embossed 7" T Paper 7" Tape specs. per EIA RS481
P/N written: 100X14W104MV4T							



X2Y® FILTER & DECOUPLING CAPACITORS

The X2Y® Design - A Capacitive Circuit

X2Y® components share many common features with standard multi-layer ceramic capacitors (MLCC) for easy adoption by end-users.

- Same component sizes (0603, 0805, 1206, etc.)
- Same dielectric, electrode and termination materials
- Same pick and place equipment
- Same industry test standards for component reliability

A standard multi-layer ceramic capacitor (MLCC) consists of opposing electrode layers A & B. The X2Y® design adds another set of electrode layers (G) which effectively surround each existing electrode of a two-terminal capacitor. The only external difference is two additional side terminations, creating a four-terminal capacitive circuit, which allows circuit designers a multitude of attachment options.

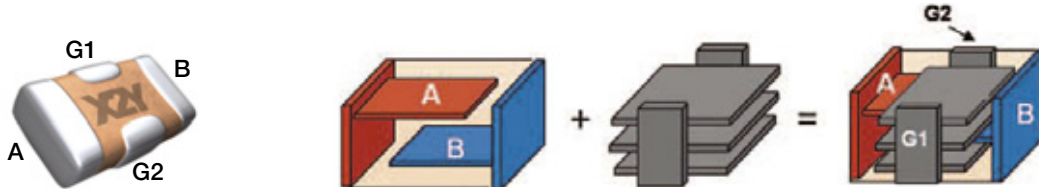

X2Y® Circuit 1: Filtering

When used in circuit 1 configuration the X2Y® filter capacitor is connected across two signal lines. Differential mode noise is filtered to ground by the two Y capacitors, A & B. Common mode noise is cancelled within the device.

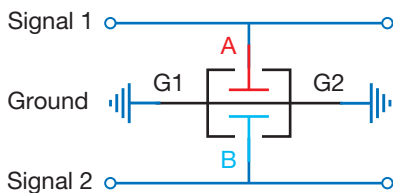

Experts agree that balance is the key to a “quiet” circuit. X2Y® is a balanced circuit device with two equal halves, tightly matched in both phase and magnitude with respect to ground. Several advantages are gained by two balanced capacitors sharing a single ceramic component body.

- Exceptional common mode rejection
- Effect of voltage variation eliminated
- Effects of aging & temperature are equal on both caps
- Matched line-to-ground capacitance

InAmp Input Filter Example

In this example, a single Johanson X2Y® component was used to filter noise at the input of a DC instrumentation amplifier. This reduced component count by 3-to-1 and costs by over 70% vs. conventional filter components that included 1% film Y-capacitors.

Parameter	X2Y® 10nF	Discrete 10nF, 2 @ 220 pF	Comments
DC offset shift	< 0.1 μ V	< 0.1 μ V	Referred to input
Common mode rejection	91 dB	92 dB	

Source: Analog Devices, “A Designer’s Guide to Instrumentation Amplifiers (2nd Edition)” by Charles Kitchin and Lew Counts

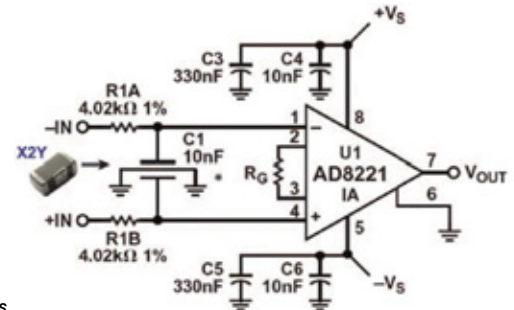

Common Mode Choke Replacement

In this example, a 5 μ H common mode choke is replaced by an 0805, 1000pF X2Y® component achieving superior EMI filtering by a component a fraction of the size and cost.

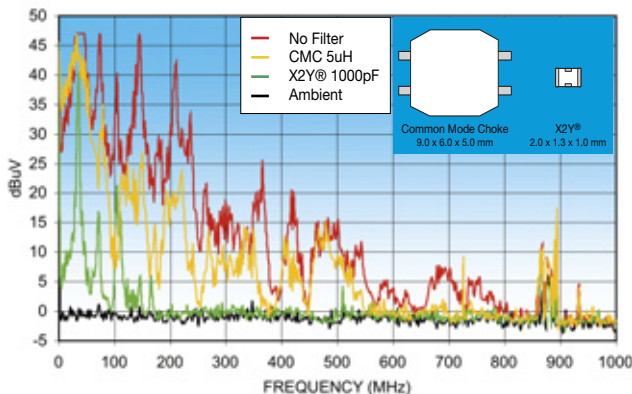

DC Motor EMI Reduction: A Superior Solution

One X2Y® component has successfully replaced 7 discrete filter components while achieving superior EMI filtering.

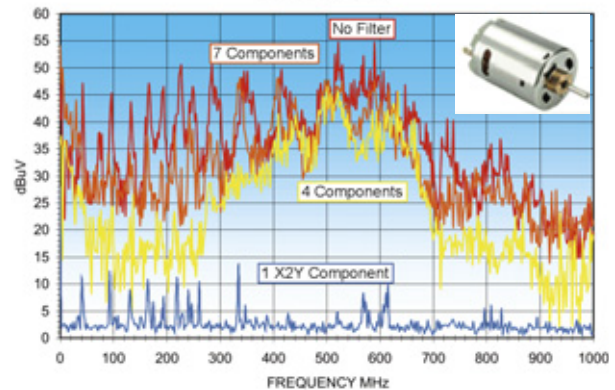

X2Y® FILTER & DECOUPLING CAPACITORS

X2Y® Circuit 2: Decoupling

When used in circuit 2 configuration, A & B capacitors are placed in parallel effectively doubling the apparent capacitance while maintaining an ultra-low inductance. The low inductance advantages of the X2Y® Capacitor Circuit enables high-performance bypass networks at reduced system cost.

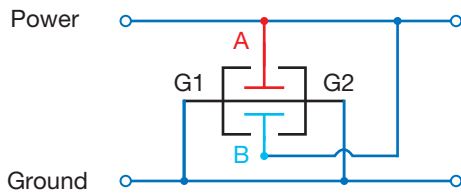

- Low ESL (device only and mounted)
- Broadband performance
- Effective on PCB or package
- Lower via count, improves routing
- Reduces component count
- Lowers placement cost

Component Performance

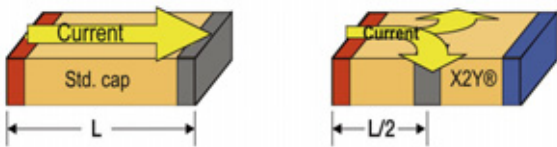

The X2Y® has short, multiple and opposing current paths resulting in lower device inductance.

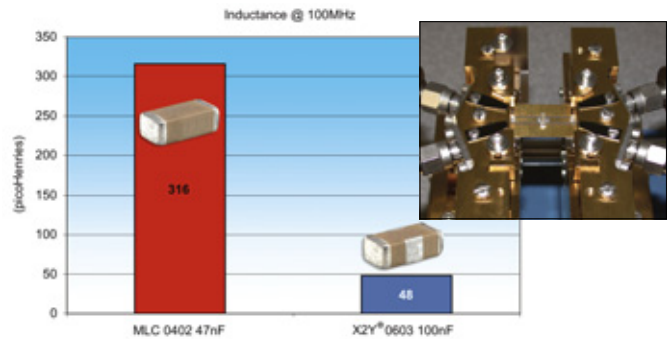

Mounted Performance

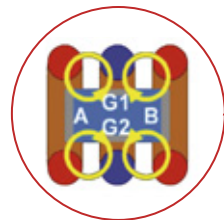
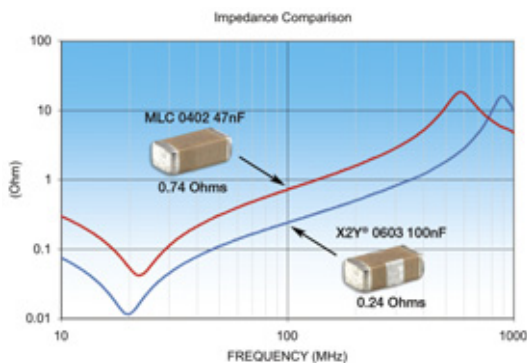

Mutual coupling from opposing polarity vias lowers inductance when mounted on a PCB.

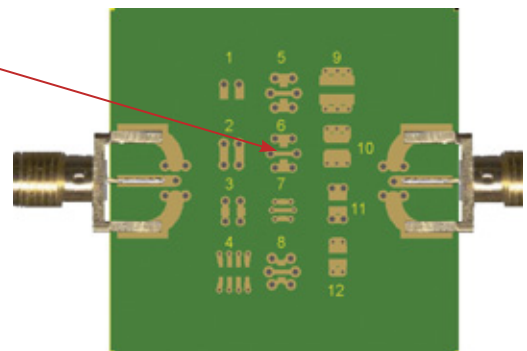

SYSTEM PERFORMANCE

1:5 MLCC Replacement Example

X2Y's® proven technology enables end-users to use one X2Y capacitor to replace five conventional MLCCs in a typical high performance IC bypass design. Vias are nearly cut in half, board space is reduced and savings are in dollars per PCB.

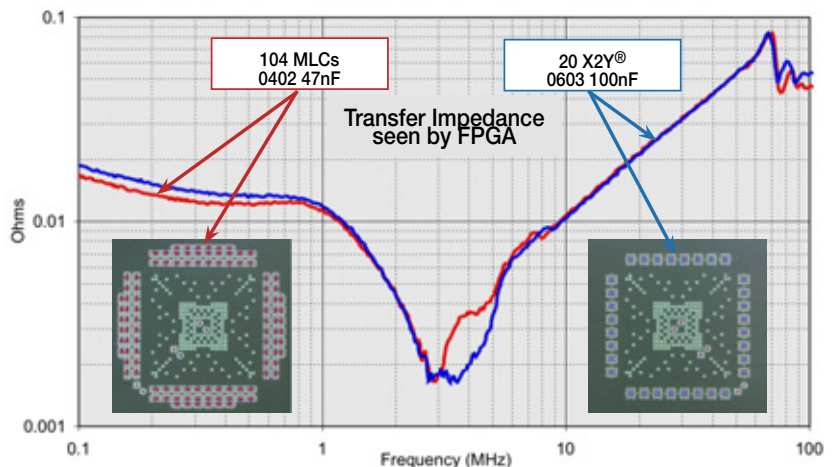

X2Y® FILTER & DECOUPLING CAPACITORS

OPTIMIZING X2Y PERFORMANCE

X2Y® low inductance capacitors deliver excellent performance in EMI/RFI filtering and power delivery bypass / decoupling applications. Physical and electrical placement on the PCB is critical in achieving best results.

In EMI Filter applications stray inductance should be minimized between signals and the A and B capacitor pads. Use star or daisy chain routes, rather than “T” to capacitor pads as shown in Figure 1.

For PDN bypass applications Figure 2 compares the X2Y® recommended layout against a poor layout. Because of its long extents from device terminals to vias, and the wide via separation, the poor layout exhibits approximately 200% L1 inductance, and 150% L2 inductance compared to recommended X2Y layouts.

As with any ceramic capacitor, hand soldering is discouraged due to the risk of thermal crack failure. If hand soldering is employed for lab evaluation, pre-heat the assembly and utilize contact-less soldering methods such as a hot air tool.

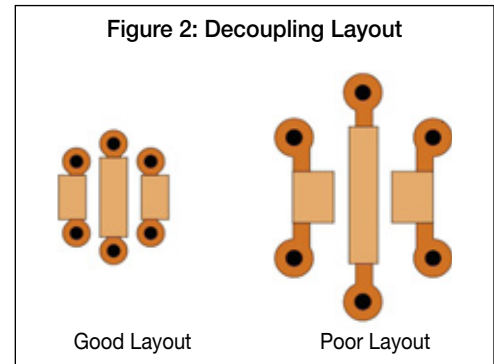
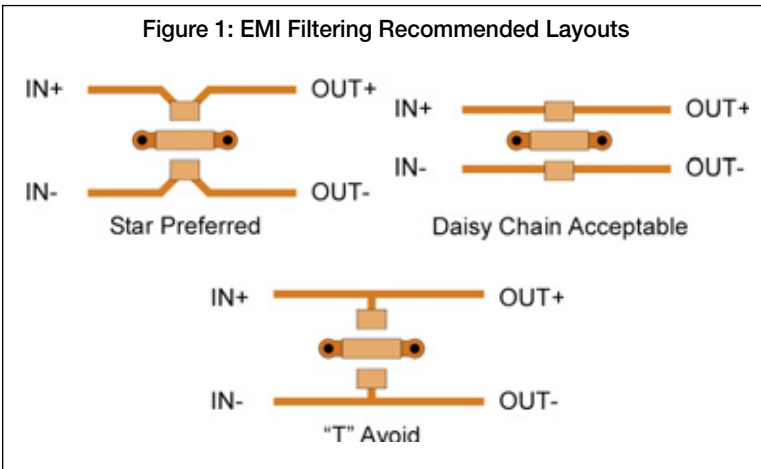

SOLDER PAD RECOMMENDATIONS

	0402 (X07)		0603 (X14)		0805 (X15)		1206 (X18)		1210 (X41)		1410 (X44)		1812 (X43)	
	IN	mm	IN	mm	IN	mm	IN	mm	IN	mm	IN	mm	IN	mm
X	0.020	0.51	0.035	0.89	0.050	1.27	0.065	1.65	0.100	2.54	0.100	2.54	0.125	3.18
Y	0.020	0.51	0.025	0.64	0.035	0.89	0.040	1.02	0.040	1.02	0.040	1.02	0.040	1.02
G	0.024	0.61	0.040	1.02	0.050	1.27	0.080	2.03	0.080	2.03	0.100	2.54	0.130	3.30
V	0.015	0.38	0.020	0.51	0.022	0.56	0.040	1.02	0.045	1.14	0.045	1.14	0.045	1.14
U	0.039	0.99	0.060	1.52	0.080	2.03	0.120	3.05	0.160	4.06	0.160	4.06	0.190	4.83
Z	0.064	1.63	0.090	2.29	0.120	3.05	0.160	4.06	0.160	4.06	0.180	4.57	0.210	5.33

Use of solder mask beneath component is not recommended because of flux/contaminant entrapment.

MECHANICAL CHARACTERISTICS

	0402 (X07)		0603 (X14)		0805 (X15)		1206 (X18)		1210 (X41)		1410 (X44)		1812 (X43)	
	IN	mm	IN	mm	IN	mm	IN	mm	IN	mm	IN	mm	IN	mm
L	0.045 ± 0.003	1.143 ± 0.076	0.064 ± 0.005	1.626 ± 0.127	0.080 ± 0.008	2.032 ± 0.203	0.124 ± 0.010	3.150 ± 0.254	0.125 ± 0.010	3.175 ± 0.254	0.140 ± 0.010	3.556 ± 0.254	0.174 ± 0.010	4.420 ± 0.254
W	0.024 ± 0.003	0.610 ± 0.076	0.035 ± 0.005	0.889 ± 0.127	0.050 ± 0.008	1.270 ± 0.203	0.063 ± 0.010	1.600 ± 0.254	0.098 ± 0.010	2.489 ± 0.254	0.098 ± 0.010	2.490 ± 0.254	0.125 ± 0.010	3.175 ± 0.254
T	0.020 max	0.508 max	0.026 max	0.660 max	0.040 max	1.016 max	0.050 max	1.270 max	0.070 max	1.778 max	0.070 max	1.778 max	0.090 max	2.286 max
EB	0.008 ± 0.003	0.203 ± 0.076	0.009 ± 0.004	0.229 ± 0.102	0.009 ± 0.004	0.229 ± 0.102	0.009 ± 0.004	0.229 ± 0.102	0.009 ± 0.005	0.229 ± 0.127	0.009 ± 0.005	0.229 ± 0.127	0.009 ± 0.005	0.229 ± 0.127
CB	0.010 ± 0.003	0.305 ± 0.076	0.018 ± 0.004	0.457 ± 0.102	0.022 ± 0.005	0.559 ± 0.127	0.040 ± 0.005	1.016 ± 0.127	0.045 ± 0.005	1.143 ± 0.127	0.045 ± 0.005	1.143 ± 0.127	0.045 ± 0.005	1.143 ± 0.127

X2Y® FILTER & DECOUPLING CAPACITORS

SIZE	TC	Y-CAPACITOR		VOLTAGE RATING (DC)	JOHANSON P/N	REEL QTY
		VALUE	TOLERANCE			
0402	NPO/COG	1.8pF	±0.5pF	50	500X07N1R8CV4T	4,000
		2.2pF	±0.5pF	50	500X07N2R2CV4T	4,000
		4.7pF	±0.5pF	50	500X07N4R7CV4T	4,000
		5.6pF	±0.5pF	50	500X07N5R6CV4T	4,000
		10pF	±20%	50	500X07N100MV4T	4,000
		22pF	±20%	50	500X07N220MV4T	4,000
		27pF	±20%	50	500X07N270MV4T	4,000
		33pF	±20%	50	500X07N330MV4T	4,000
		47pF	±20%	50	500X07N470MV4T	4,000
	100pF	±20%	50	500X07N101MV4T	4,000	
	X7R	100pF	±20%	50	500X07W101MV4T	4,000
		220pF	±20%	50	500X07W221MV4T	4,000
		470pF	±20%	50	500X07W471MV4T	4,000
		1.0nF	±20%	50	500X07W102MV4T	4,000
		1.5nF	±20%	50	500X07W152MV4T	4,000
		2.2nF	±20%	50	500X07W222MV4T	4,000
		4.7nF	±20%	50	500X07W472MV4T	4,000
		10nF	±20%	16	160X07W103MV4T	4,000
0603		NPO/COG	1.8pF	±20%	100	101X14N1R8CV4T
	2.2pF		±20%	100	101X14N2R0CV4T	4,000
	4.7pF		±20%	100	101X14N4R7CV4T	4,000
	5.6pF		±20%	100	101X14N5R6CV4T	4,000
	10pF		±20%	100	101X14N100MV4T	4,000
	22pF		±20%	100	101X14N220MV4T	4,000
	27pF		±20%	100	101X14N270MV4T	4,000
	33pF		±20%	100	101X14N330MV4T	4,000
	47pF		±20%	100	101X14N470MV4T	4,000
	100pF		±20%	50	500X14N101MV4T	4,000
	220pF		±20%	50	500X14N221MV4T	4,000
	X7R	47pF	±20%	100	101X14W470MV4T	4,000
		100pF	±20%	100	101X14W101MV4T	4,000
		220pF	±20%	100	101X14W221MV4T	4,000
		470pF	±20%	100	101X14W471MV4T	4,000
		1.0nF	±20%	100	101X14W102MV4T	4,000
		1.5nF	±20%	100	101X14W152MV4T	4,000
		2.2nF	±20%	100	101X14W222MV4T	4,000
		4.7nF	±20%	100	101X14W472MV4T	4,000
		10nF	±20%	50	500X14W103MV4T	4,000
		15nF	±20%	25	250X14W153MV4T	4,000
		22nF	±20%	25	250X14W223MV4T	4,000
47nF	±20%	16	160X14W473MV4T	4,000		
100nF	±20%	10	100X14W104MV4T	4,000		
220nF	±20%	6.3	6R3X14W224MV4T	4,000		

Parts listed in the table are standard parts and carry the highest DC voltage rating for their size and value. Legacy part number requirements for lower voltage codes are fulfilled with the higher voltage rating which exceeds the requirement.

Please contact the factory for part values or voltage combinations that are not shown.



X2Y® FILTER & DECOUPLING CAPACITORS

SIZE	TC	Y-CAPACITOR		VOLTAGE RATING (DC)	JOHANSON P/N	REEL QTY
		VALUE	TOLERANCE			
0805	NPO/COG	10pF	±20%	100	101X15N100MV4E	4,000
		22pF	±20%	100	101X15N220MV4E	4,000
		27pF	±20%	100	101X15N270MV4E	4,000
		33pF	±20%	100	101X15N330MV4E	4,000
		47pF	±20%	100	101X15N470MV4E	4,000
		100pF	±20%	100	101X15N101MV4E	4,000
		220pF	±20%	50	500X15N221MV4E	4,000
		470pF	±20%	50	500X15N471MV4E	4,000
	X7R	47pF	±20%	100	101X15W470MV4E	4,000
		100pF	±20%	100	101X15W101MV4E	4,000
		220pF	±20%	100	101X15W221MV4E	4,000
		470pF	±20%	100	101X15W471MV4E	4,000
		1nF	±20%	100	101X15W102MV4E	4,000
		1.5nF	±20%	100	101X15W152MV4E	4,000
		2.2nF	±20%	100	101X15W222MV4E	4,000
		4.7nF	±20%	100	101X15W472MV4E	4,000
		10nF	±20%	100	101X15W103MV4E	4,000
		15nF	±20%	50	500X15W153MV4E	4,000
		22nF	±20%	50	500X15W223MV4E	4,000
		47nF	±20%	50	500X15W473MV4E	4,000
100nF	±20%	25	250X15W104MV4E	4,000		
180nF	±20%	10	100X15W184MV4E	4,000		
1206	NPO/COG	1nF	±20%	100	101X18N102MV4E	3,000
	X7R	10nF	±20%	100	101X18W103MV4E	3,000
		15nF	±20%	100	101X18W153MV4E	3,000
		22nF	±20%	100	101X18W223MV4E	3,000
		47nF	±20%	100	101X18W473MV4E	3,000
		100nF	±20%	100	101X18W104MV4E	3,000
		220nF	±20%	16	160X18W224MV4E	3,000
		330nF	±20%	16	160X18W334MV4E	3,000
470nF	±20%	10	100X18W474MV4E	3,000		
1210	X7R	100nF	±20%	100	101X41W104MV4E	2,000
		220nF	±20%	100	101X41W224MV4E	2,000
		330nF	±20%	100	101X41W334MV4E	2,000
		1000nF	±20%	16	160X41W105MV4E	2,000
1410	X7R	400nF	±20%	100	101X44W404MV4E	2,000
1812	X7R	330nF	±20%	100	101X43W334MV4E	1,000
		470nF	±20%	100	101X43W474MV4E	1,000

Parts listed in the table are standard parts and carry the highest DC voltage rating for their size and value.

Legacy part number requirements for lower voltage codes are fulfilled with the higher voltage rating which exceeds the requirement.

Please contact the factory for part values or voltage combinations that are not shown.

Johanson Dielectrics, Inc. reserves the right to make design and price changes without notice. All sales are subject to the terms and conditions printed on the back side of our sales order acknowledgment forms, including a limited warranty and remedies for non-conforming goods or defective goods. We will be pleased to provide a copy of these terms and conditions for your review.

JOHANSON HONG KONG LTD.

Unit E, 11/F., Phase 1, Kaiser Estate
41 Man Yue Street
Hungghom, Kowloon, Hong Kong
Tel: (852) 2334 6310 • Fax: (852) 2334 8858



15191 Bledsoe Street
Sylmar, California 91342
Tel (818) 364-9800 • FAX (818) 364-6100
<http://www.johansondielectrics.com>

JOHANSON EUROPE LTD.

Acorn House, Old Kiln Road
Flackwell Heath, Bucks HP10 9NR
United Kingdom
Tel +44-162-853-1154 • Fax +44-162-853-2703