

MOS FET Relays

G3VM-41HR

**Low 30-mΩ ON Resistance.
Higher power, 2.5-A switching with a
40-V load voltage, SOP package.**

- Continuous load current of 2.5 A (connection C = 5 A).
- Dielectric strength of 1,500 Vrms between I/O.

RoHS compliant

⚠ Refer to "Common Precautions".

NEW

Application Examples

- Broadband systems
- Measurement devices
- Data loggers
- Industrial equipment

Note: The actual product is marked differently from the image shown here.

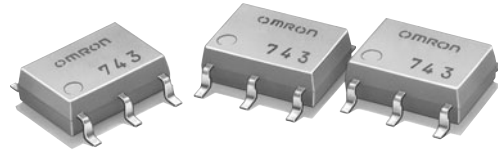

List of Models

Contact form	Terminals	Load voltage (peak value) (See note.)	Model	Number per stick	Number per tape
SPST-NO	Surface-mounting terminals	40 V	G3VM-41HR	75	---
			G3VM-41HR(TR)	---	2,500

Note: The AC peak and DC value is given for the load voltage.

Dimensions

Note: All units are in millimeters unless otherwise indicated.

G3VM-41HR

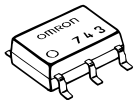

Note: The actual product is marked differently from the image shown here.

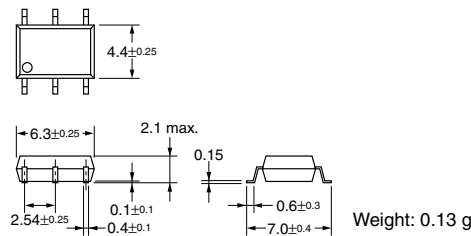

Terminal Arrangement/Internal Connections (Top View)

G3VM-41HR

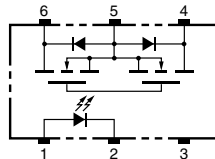

Actual Mounting Pad Dimensions (Recommended Value, Top View)

G3VM-41HR

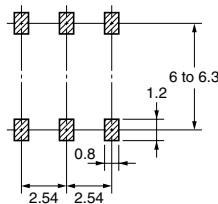

Absolute Maximum Ratings (Ta = 25°C)

Item		Symbol	Rating	Unit	Measurement Conditions	
Input	LED forward current	I_F	30	mA		
	LED forward current reduction rate	$\Delta I_F/^\circ\text{C}$	-0.3	mA/°C	Ta ≥ 25°C	
	LED reverse voltage	V_R	5	V		
	Connection temperature	T_j	125	°C		
Output	Load voltage (AC peak/DC)	V_{OFF}	40	V		
	Continuous load current	Connection A	I_O	2.5	A	Connection A: AC peak/DC Connection B and C: DC
		Connection B		2.5		
		Connection C		5		
	ON current reduction rate	Connection A	$\Delta I_O/^\circ\text{C}$	-33.3	mA/°C	Ta ≥ 50°C
		Connection B		-33.3		
		Connection C		-66.7		
Pulse on current	I_{op}	7.5	A	t = 100 ms		
Connection temperature	T_j	125	°C			
Dielectric strength between input and output (See note 1.)		V_{I-O}	1,500	Vrms	AC for 1 min	
Operating temperature		T_a	-40 to +85	°C	With no icing or condensation	
Storage temperature		T_{stg}	-55 to +125	°C	With no icing or condensation	
Soldering temperature (10 s)		---	260	°C	10 s	

Note: 1. The dielectric strength between the input and output was checked by applying voltage between all pins as a group on the LED side and all pins as a group on the light-receiving side.

Connection Diagram

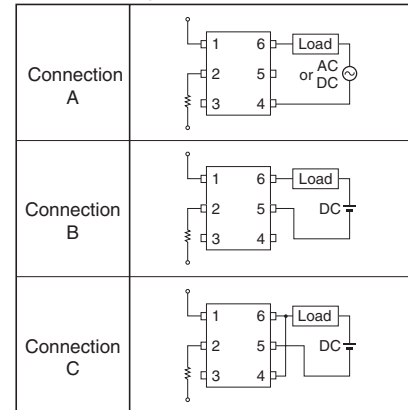

Electrical Characteristics (Ta = 25°C)

Item		Symbol	Minimum	Typical	Maximum	Unit	Measurement conditions	
Input	LED forward voltage	V_F	1.18	1.33	1.48	V	$I_F = 10 \text{ mA}$	
	Reverse current	I_R	---	---	10	μA	$V_R = 5 \text{ V}$	
	Capacity between terminals	C_T	---	70	---	pF	V = 0, f = 1 MHz	
	Trigger LED forward current	I_{FT}	---	0.4	3	mA	$I_O = 100 \text{ mA}$	
Output	Maximum resistance with output ON	Connection A	R_{ON}	---	0.03	0.06	Ω	$I_F = 5 \text{ mA}, I_O = 2 \text{ A}, t < 1 \text{ s}$
		Connection B		---	0.015	0.03	Ω	$I_F = 5 \text{ mA}, I_O = 2 \text{ A}, t < 1 \text{ s}$
		Connection C		---	0.008	---	Ω	$I_F = 5 \text{ mA}, I_O = 4 \text{ A}, t < 1 \text{ s}$
	Current leakage when the relay is open	I_{LEAK}	---	---	10	nA	$V_{OFF} = 40 \text{ V}$	
Capacity between I/O terminals		C_{I-O}	---	0.8	---	pF	f = 1 MHz, $V_s = 0 \text{ V}$	
Insulation resistance		R_{I-O}	1,000	---	---	MΩ	$V_{I-O} = 500 \text{ VDC}, \text{RoH} \leq 60\%$	
Turn-ON time		t_{ON}	---	1.0	5.0	ms	$I_F = 5 \text{ mA}, R_L = 200 \text{ } \Omega, V_{DD} = 20 \text{ V}$ (See note 2.)	
Turn-OFF time		t_{OFF}	---	0.15	1.0	ms		

Note: 2. Turn-ON and Turn-OFF Times

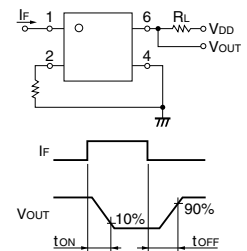

Recommended Operating Conditions

Use the G3VM under the following conditions so that the Relay will operate properly.

Item	Symbol	Minimum	Typical	Maximum	Unit
Load voltage (AC peak/DC)	V_{DD}	---	---	40	V
Operating LED forward current	I_F	5	7.5	20	mA
Continuous load current (AC peak/DC)	I_O	---	---	2	A
Operating temperature	T_a	-20	---	65	°C

Engineering Data

Load Current vs. Ambient Temperature G3VM-41HR

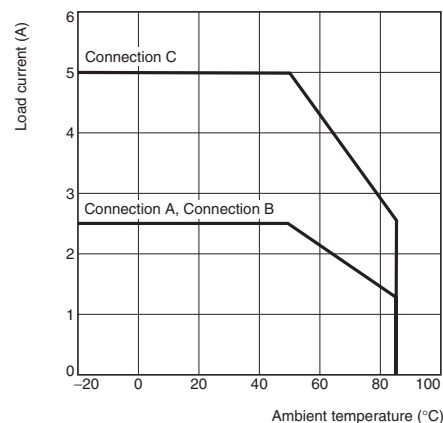

Safety Precautions

Refer to "Common Precautions" for all G3VM models.