

MULTILAYER CERAMIC CAPACITORS

High Q / Low ESR Series (HH)

1. INTRODUCTION

MLCC consists of a conducting material and electrodes. To manufacture a chip-type SMT and achieve miniaturization, high density and high efficiency, ceramic condensers are used.

WTC HH series MLCC is used at high frequencies generally have a small temperature coefficient of capacitance, typical within the $\pm 30\text{ppm}/^\circ\text{C}$ required for NP0 (COG) classification and have excellent conductivity internal electrode. Thus, WTC HH series MLCC will be with the feature of low ESR and high Q characteristics.

2. FEATURES

- a. High Q and low ESR performance at high frequency.
- b. Quality improvement of telephone calls for low power loss and better performance.

3. APPLICATIONS

- a. Mobile telecommunication: Mobile phone, WLAN.
- b. RF module: Power amplifier, VCO.
- c. Tuners.

4. HOW TO ORDER

<u>HH</u>	<u>15</u>	<u>N</u>	<u>100</u>	<u>G</u>	<u>500</u>	<u>L</u>	<u>I</u>
<u>Series</u>	<u>Size</u>	<u>Dielectric</u>	<u>Capacitance</u>	<u>Tolerance</u>	<u>Rated voltage</u>	<u>Termination</u>	<u>Packaging</u>
HH=High Q/ Low ESR	15=0402 (1005) 18=0603 (1608) 21=0805 (2012)	N=NP0 (COG)	Two significant digits followed by no. of zeros. And R is in place of decimal point. eg.: R47=0.47pF 0R5=0.5pF 1R0=1.0pF 100=10x10 ⁰ =10pF	B=±0.1pF C=±0.25pF D=±0.5pF F=±1% G=±2% J=±5%	Two significant digits followed by no. of zeros. And R is in place of decimal point. 160=16 VDC 250=25 VDC 500=50 VDC 101=100 VDC	L=Ag/Ni/Sn	T=7" reeled G= 13" reeled

5. EXTERNAL DIMENSIONS

Size Inch (mm)	L (mm)	W (mm)	T (mm)/Symbol	M _B (mm)	
0402 (1005)	1.00±0.05	0.50±0.05	0.50±0.05	N	0.25 +0.05/-0.10
0603 (1608)	1.60±0.10	0.80±0.10	0.80±0.07	S	0.40±0.15
0805 (2012)	2.00±0.15	1.25±0.10	0.60±0.10	A	0.50±0.20

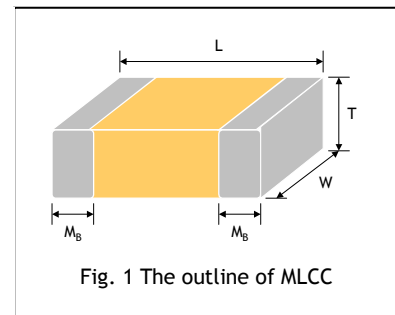

Fig. 1 The outline of MLCC

0402 size : Reflow soldering only.

6. GENERAL ELECTRICAL DATA

Dielectric	NPO
Size	0402, 0603, 0805
Capacitance*	0402: 0.1pF to 470pF 0603: 0.5pF to 3300pF 0805: 0.5pF to 150pF
Capacitance tolerance	Cap≤5pF: B (±0.1pF), C (±0.25pF) 5pF<Cap<10pF: C (±0.25pF), D (±0.5pF) Cap≥10pF: F (±1%), G (±2%), J (±5%)
Rated voltage (WVDC)	16V, 25V, 50V, 100V
Q*	Cap<30pF: Q≥400+20C Cap≥30pF: Q≥1000
Insulation resistance at Ur	≥10GΩ
Operating temperature	-55 to +125 °C
Capacitance change	±30ppm
ESR	Cap<2.2pF: ≤1000mΩ@900±100MHz 2.2pF≤Cap≤470pF: ≤500mΩ@900±100MHz Cap>470pF: ≤500mΩ@60±10MHz
Termination	Ni/Sn (lead-free termination)

* Measured at the conditions of 25 °C ambient temperature and 30-70% related humidity.

Apply 1.0±0.2Vrms, 1.0MHz±10% for Cap≤1000pF and 1.0±0.2Vrms, 1.0kHz±10% for Cap>1000pF.

MULTILAYER CERAMIC CAPACITORS

High Q / Low ESR Series (HH)

7. CAPACITANCE RANGE

DIELECTRIC		NPO								
SIZE		0402			0603				0805	
RATED VOLTAGE (VDC)		16	25	50	16	25	50	100	50	100
Capacitance	0.1pF (0R1)	N	N	N						
	0.2pF (0R2)	N	N	N						
	0.3pF (0R3)	N	N	N						
	0.4pF (0R4)	N	N	N						
	0.5pF (0R5)	N	N	N	S	S	S	S	A	A
	0.6pF (0R6)	N	N	N	S	S	S	S	A	A
	0.7pF (0R7)	N	N	N	S	S	S	S	A	A
	0.8pF (0R8)	N	N	N	S	S	S	S	A	A
	0.9pF (0R9)	N	N	N	S	S	S	S	A	A
	1.0pF (1R0)	N	N	N	S	S	S	S	A	A
	1.2pF (1R2)	N	N	N	S	S	S	S	A	A
	1.5pF (1R5)	N	N	N	S	S	S	S	A	A
	1.8pF (1R8)	N	N	N	S	S	S	S	A	A
	2.2pF (2R2)	N	N	N	S	S	S	S	A	A
	2.7pF (2R7)	N	N	N	S	S	S	S	A	A
	3.3pF (3R3)	N	N	N	S	S	S	S	A	A
	3.9pF (3R9)	N	N	N	S	S	S	S	A	A
	4.7pF (4R7)	N	N	N	S	S	S	S	A	A
	5.6pF (5R6)	N	N	N	S	S	S	S	A	A
	6.8pF (6R8)	N	N	N	S	S	S	S	A	A
	8.2pF (8R2)	N	N	N	S	S	S	S	A	A
	10pF (100)	N	N	N	S	S	S	S	A	A
	12pF (120)	N	N	N	S	S	S	S	A	A
	15pF (150)	N	N	N	S	S	S	S	A	A
	18pF (180)	N	N	N	S	S	S	S	A	A
	22pF (220)	N	N	N	S	S	S	S	A	A
	27pF (270)	N	N	N	S	S	S	S	A	A
	33pF (330)	N	N	N	S	S	S	S	A	A
	39pF (390)	N	N	N	S	S	S	S	A	A
	47pF (470)	N	N	N	S	S	S	S	A	A
	56pF (560)	N	N	N	S	S	S	S	A	A
	68pF (680)	N	N	N	S	S	S	S	A	A
	82pF (820)	N	N	N	S	S	S	S	A	A
100pF (101)	N	N	N	S	S	S	S	A	A	
120pF (121)	N	N	N	S	S	S	S	A	A	
150pF (151)	N	N	N	S	S	S	S	A	A	
180pF (181)	N	N	N	S	S	S	S			
220pF (221)	N	N	N	S	S	S	S			
270pF (271)	N	N	N	S	S	S	S			
330pF (331)	N	N	N	S	S	S	S			
390pF (391)	N	N	N	S	S	S	S			
470pF (471)	N	N	N	S	S	S	S			
560pF (561)				S	S	S				
680pF (681)				S	S	S				
820pF (821)				S	S	S				
1,000pF (102)				S	S	S				
1,200pF (122)				X						
1,500pF (152)				X						
1,800pF (182)				X						
2,200pF (222)				X						
2,700pF (272)				X						
3,300pF (332)				X						

1. The letter in cell is expressed the symbol of product thickness.
2. For more information about products with special capacitance or other data, please contact WTC local representative.

8. PACKAGING DIMENSION AND QUANTITY

Size	Thickness (mm)/Symbol		Paper tape	
			7" reel	13" reel
0402	0.50±0.05	N	10K	20K
0603	0.80±0.07	S	4K	15K
0805	0.60±0.10	A	4k	15k

Unit: pieces

9. ELECTRICAL CHARACTERISTICS

Q factor specification vs. Specific frequency

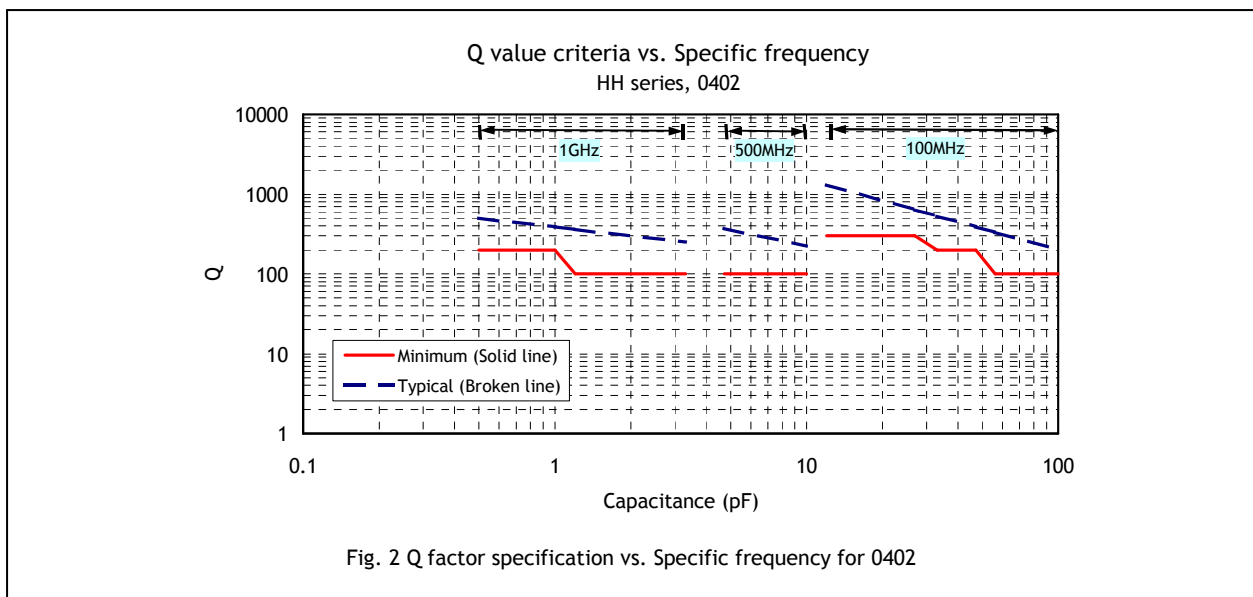

Q factor specification vs. Specific frequency

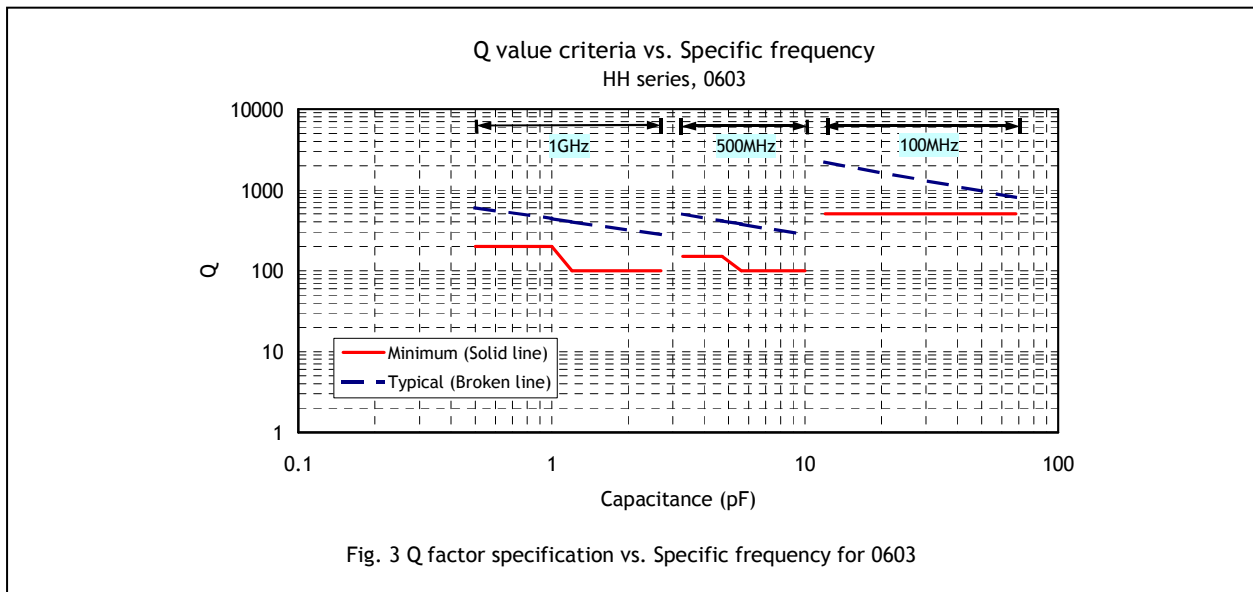

Typical ESR vs. Frequency

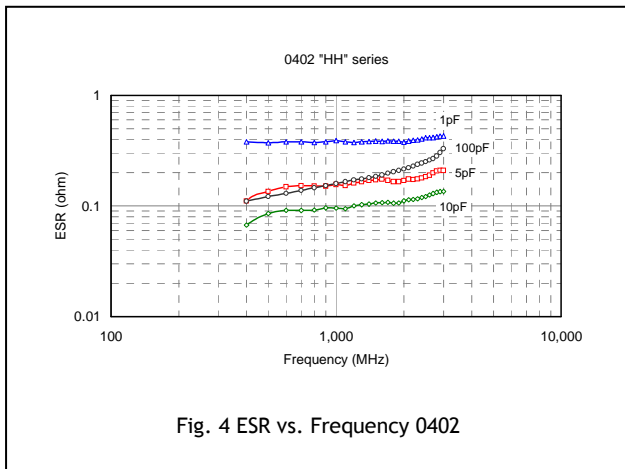

Fig. 4 ESR vs. Frequency 0402

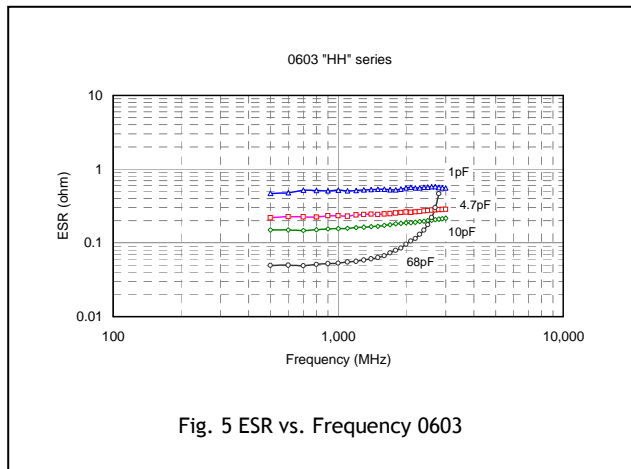

Fig. 5 ESR vs. Frequency 0603

Typical Impedance vs. Frequency

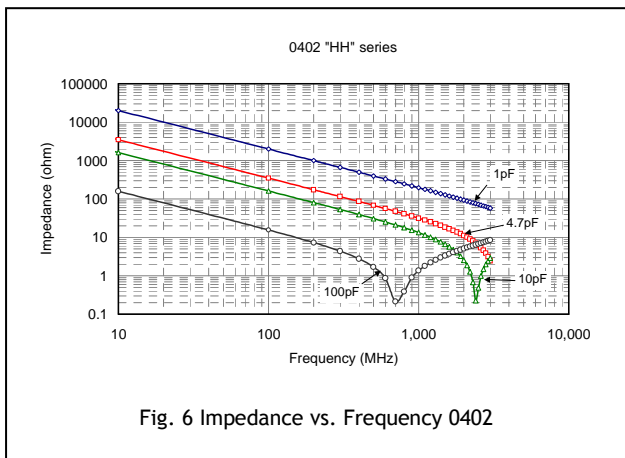

Fig. 6 Impedance vs. Frequency 0402

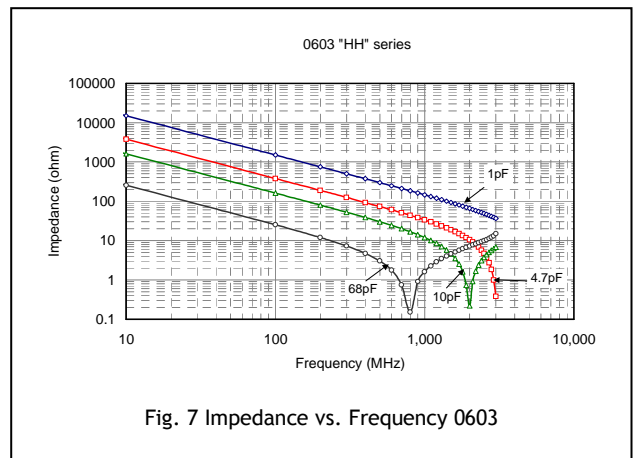

Fig. 7 Impedance vs. Frequency 0603

SRF vs. Capacitance

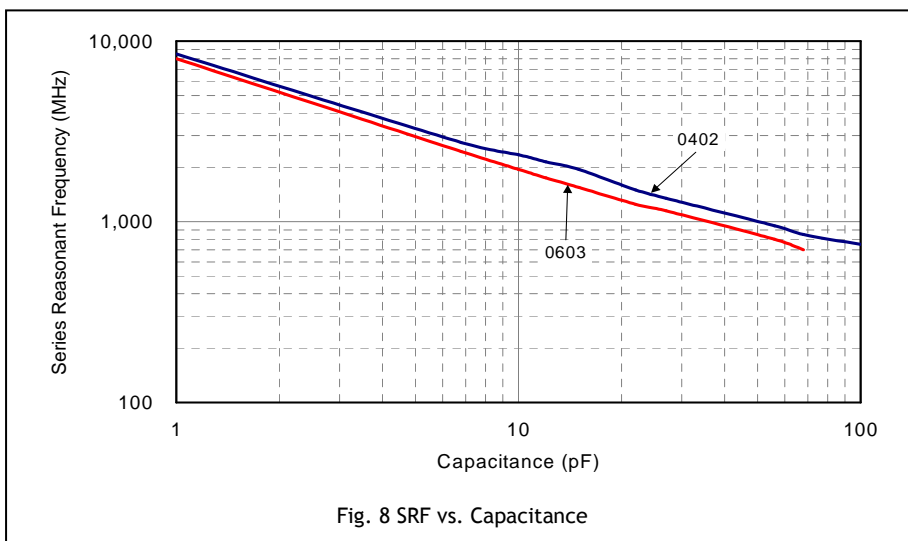

Fig. 8 SRF vs. Capacitance

APPENDIXES

▣ Tape & reel dimensions

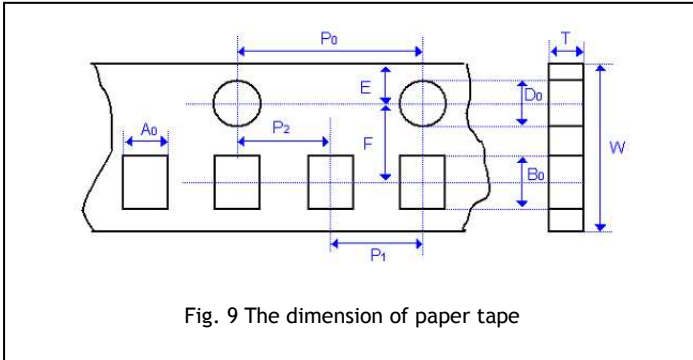

Fig. 9 The dimension of paper tape

Size	0402	0603	0805
Thickness	N	S	A
A ₀	0.62±0.05	1.02±0.05	1.50±0.10
B ₀	1.12±0.05	1.82±0.05	2.30±0.10
T	0.60±0.05	0.95±0.05	0.75±0.05
K ₀	-	-	-
W	8.00±0.10	8.00±0.10	8.00±0.10
P ₀	4.00±0.10	4.00±0.10	4.00±0.10
10xP ₀	40.0±0.10	40.0±0.10	40.0±0.10
P ₁	2.00±0.05	4.00±0.10	4.00±0.10
P ₂	2.00±0.05	2.00±0.05	2.00±0.05
D ₀	1.55±0.05	1.55±0.05	1.55±0.05
D ₁	-	-	-
E	1.75±0.05	1.75±0.05	1.75±0.05
F	3.50±0.05	3.50±0.05	3.50±0.05

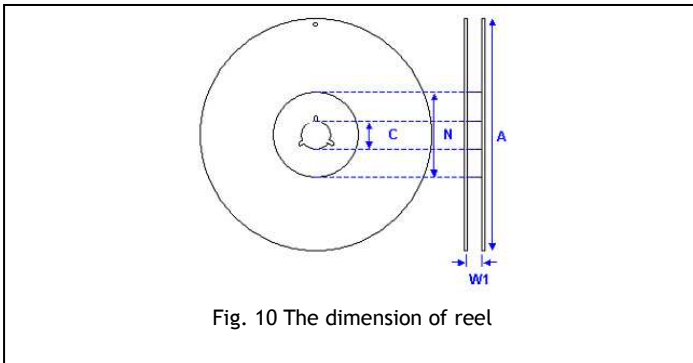
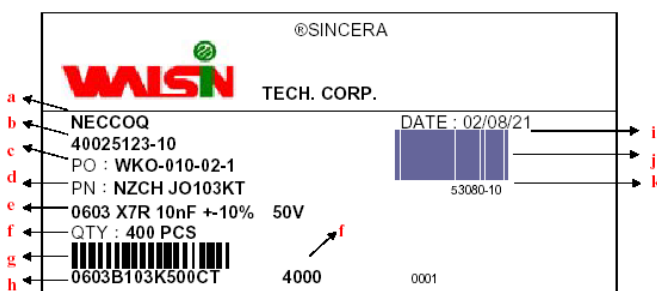

Fig. 10 The dimension of reel

Size	0402, 0603, 0805	
Reel size	7"	13"
C	13.0+0.5/-0.2	13.0+0.5/-0.2
W ₁	8.4+1.5/-0	8.4+1.5/-0
A	178.0±0.10	330.0±1.0
N	60.0+1.0/-0	100±1.0

▣ Description of customer label



- a. Customer name
- b. WTC order series and item number
- c. Customer P/O
- d. Customer P/N
- e. Description of product
- f. Quantity
- g. Bar code including quantity & WTC P/N or customer
- h. WTC P/N
- i. Shipping date
- j. Order bar code including series and item numbers
- k. Serial number of label

▣ Constructions

No.	Name	NPO	
①	Ceramic material	BaTiO ₃ based	
②	Inner electrode	AgPd alloy	
③	Termination	Inner layer	Ag
④		Middle layer	Ni
⑤		Outer layer	Sn (Matt)

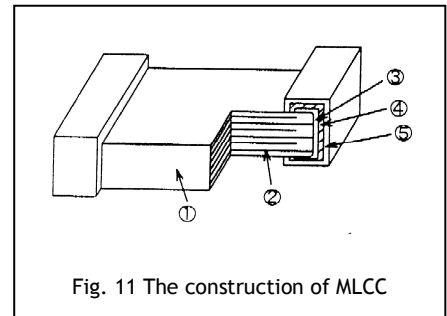

Fig. 11 The construction of MLCC

▣ Storage and handling conditions

- (1) To store products at 5 to 40°C ambient temperature and 20 to 70% related humidity conditions.
- (2) The product is recommended to be used within one year after shipment. Check solderability in case of shelf life extension is needed.

Cautions:

- a. Don't store products in a corrosive environment such as sulfide, chloride gas, or acid. It may cause oxidization of electrode, which easily be resulted in poor soldering.
- b. To store products on the shelf and avoid exposure to moisture.
- c. Don't expose products to excessive shock, vibration, direct sunlight and so on.

▣ Recommended soldering conditions

The lead-free termination MLCCs are not only to be used on SMT against lead-free solder paste, but also suitable against lead-containing solder paste. If the optimized solder joint is requested, increasing soldering time, temperature and concentration of N₂ within oven are recommended.

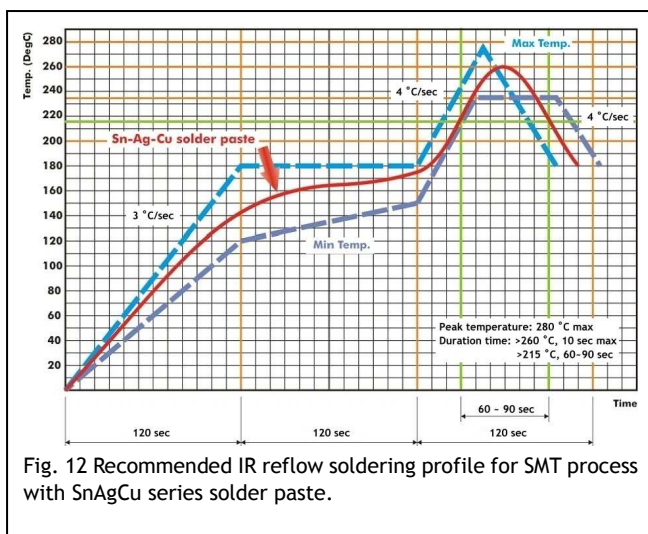

Fig. 12 Recommended IR reflow soldering profile for SMT process with SnAgCu series solder paste.

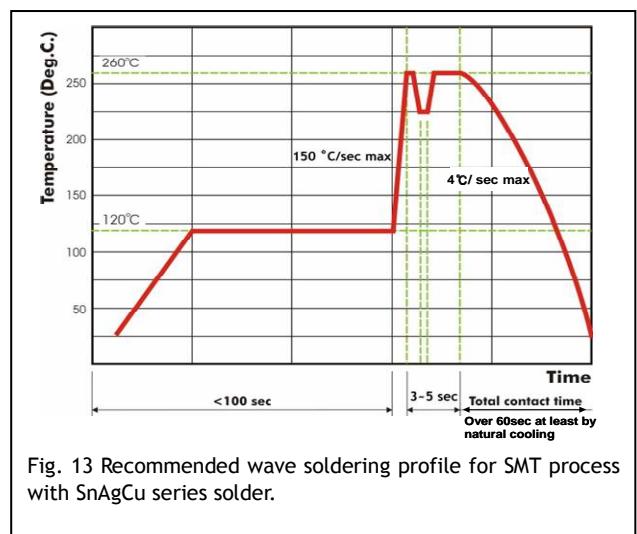

Fig. 13 Recommended wave soldering profile for SMT process with SnAgCu series solder.