



**Ultra Low Offset Voltage
 Operational Amplifier**

FEATURES

- Low offset V_{os} $25\mu V$ max.....
- Low drift vs. temperature:..... $0.3\mu V/^{\circ}C$
- High CMMR $1.0 mV/V_{Max}$
- High PSRR $3\mu V/V$ Min
- Low power $60 mW$ Max
- High gain $5,000,000 V/mV$ Min
- Direct replacement for OP-07,725, 108A/308A, 741 sockets

APPLICATIONS

- Sampling & Hold Amplifiers
- Integrators
- Medical Instrumentation
- Strain Gauge & Thermocouple
- Precision Absolute Value Circuits

PRODUCT DESCRIPTION

The ALPHA Semiconductor AS OP-77 is the next generation of OP-07. The OP-77 offers very high open-loop gain of 10,000,000 over the full $\pm 10V$ output range. The low initial offset drift with the low power dissipation of 50 mW makes OP-77 a significant improvement over the similar, previous operational amplifiers. PSRR of $3\mu V/V$ (110 dB) and CMRR of $1.0\mu V/V$ maximum, virtually eliminates errors caused by power supply drift and common-mode signal.

The OP-77 is available in several different grades. The AS OP-77 is available in hermetically sealed TO-99 metal can, plastic DIP 8-pin and 8-pin plastic SOIC packages. The operating temperature is $0^{\circ}C$ to $70^{\circ}C$ and $-55^{\circ}C$ to $+125^{\circ}C$. The AS OP-77 is a direct replacement for the OP-07, 05, 725, or 108A OP amps.

ORDERING INFORMATION

TO-99 8-PIN	PLASTIC DIP 8-PIN	PLASTIC SOIC 8-PIN	TA=25°C V _{os} Max (mv)	Oper. Temp. Range
OP77AJ			25	MIL.
OP77EJ			25	IND
OP77BJ			60	MIL.
OP77FJ			60	IND
	OP77FP	OP77FS	60	COM
	OP77GP	OP77GS	100	COM.

PIN CONNECTIONS

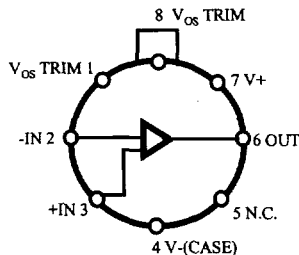

Bottom View

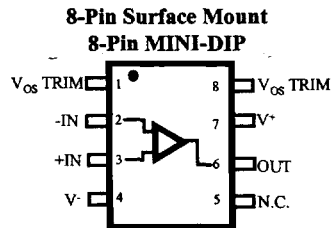

Top View

ABSOLUTE MAXIMUM RATINGS (Note 2)

Supply Voltage.....	±22V
Internal Power Dissipation (Note 1).....	500mW
Differential Input Voltage.....	±30V
Input Voltage (Note 2).....	±22V
Output Short-Circuit Duration.....	Indefinite
Storage Temperature Range	
J Package.....	-65 to +150°C
P and SO Packages.....	-65 to +125°C
Operating Temperature Range	
OP77A, OP77B (J).....	-55 to +125°C
OP77E, OP77F (J).....	-40 to +85°C
OP77F, OP77G(P,S).....	0 to +70°C
Junction Temperature(T _j).....	-65 to +150°C
Lead Temperature (Soldering, 60 Sec.).....	300°C

NOTES:

1. See Table for maximum ambient temperature rating and derating factor.
2. Absolute maximum ratings apply to both DICE and packaged parts unless otherwise noted.
3. For supply voltages less than ±22V, the absolute maximum input voltage is equal to the supply voltage.

PACKAGE TYPE	MAXIMUM AMBIENT TEMPERATURE FOR RATING	DERATE ABOVE MAXIMUM AMBIENT TEMPERATURE
TO-99(J)	80°C	7.1 mW/°C
9-Pin Plastic DIP (P)	36°C	5.6 mW/°C
8 pin SOIC	36°C	5.6 mW/°C

ELECTRICAL CHARACTERISTICS at V_S=±15V, T_a=25°C, unless otherwise specified.

Parameter	Symbol	Conditions	OP-77A			OP-77B			Units
			Min.	Typ.	Max.	Min.	Typ.	Max.	
Input Offset Voltage	V _{os}			10	25		20	60	μV
Long-Term Input Offset Voltage Stability	V _{OS} /Time	(Note 1)		0.2			0.2		μV/M _o
Input Offset Current	I _{os}			0.3	1.5		0.3	2.8	nA
Input Bias Current	I _B		0.2	1.2	2.0	0.2	1.2	2.8	nA
Input Noise Voltage (Note 2)	e _{npp}	0.1Hz to 10Hz		0.35	0.6		0.35	0.6	μV _{r,p}
Input Noise Current (Note 2)	i _{npp}	0.1 Hz to 10Hz		14	30		14	30	pA _{r,p}
Input Resistance-Differential-Mode	R _{in}	(Note 3)	26	45		18.5	45		MΩ
Input Resistance-Common-Mode	R _{inCM}			200			200		GΩ
Input Voltage Range	IVR		±13	±14		±13	±14		V
Common-Mode Rejection Ratio	CMRR	V _{CM} =±13.0		0.1	1.0		0.1	1.6	μV/V
Power Supply Rejection Ratio	PSRR	V _S =±3V to ±18		0.7	3		0.7	3	μV/V
Large-Signal Voltage Gain	A _V O	R _L ≥ 2kΩ, V _o =±10V	5000	12000		2000	8000		V/mV
Output Voltage Swing	V _o	R _L ≥ 10kΩ	±13.5	±14.0		±13.5	±14.0		V
Output Voltage Swing	V _o	R _L ≥ 2kΩ	±12.5	±13.0		±12.5	±13.0		V
Output Voltage Swing	V _o	R _L ≥ 1kΩ	±12.0	±12.5		±12.0	±12.5		V
Slew Rate	SR	R _L ≥ 2kΩ	0.1	0.3		0.1	0.3		V/μs
Closed-Loop Bandwidth	BW	A _{vcl} =+1.0(Note 1)	0.4	0.6		0.4	0.6		MHz
Open-Loop Output Resistance	R _o	V _o =0, I _o =0		60			60		Ω
Power Consumption	P _d	V _S =±15V, No Load		50	60		50	60	mW
Power Consumption	P _d	V _S =±3V, No load		3.5	4.5		3.5	4.5	mW
Offset Adjustment Range		R _p = 20kΩ		+3			+3		mV

Notes:

1. Long term input offset voltage stability refers to the averaged trend line of V_{os} vs. time over extended periods after the first 30 days of operation. Excluding the initial hour of operation, changes in V_{os} during the first 30 operating days are typically 2.5 mV.
2. Sample tested
3. Guaranteed by design.

ELECTRICAL CHARACTERISTICS at $V_s = \pm 15V$, $T_a = 25^\circ C$, unless otherwise specified.

Parameter	Symbol	Conditions	OP-77E			OP-77F			OP-77G			Units
			Min.	Typ.	Max.	Min.	Typ.	Max.	Min.	Typ.	Max.	
Input Offset Voltage	V_{os}			10	25		20	60		50	100	μV
Long-Term V_{os} Stability	V_{os}/Time	(Note 1)		0.3			0.4			0.4		$\mu V/M_o$
Input Offset Current	I_{os}			0.3	1.5		0.3	2.8		0.3	2.8	nA
Input Bias Current	I_B		0.2	1.2	2.0	0.2	1.2	2.8	0.2	1.2	2.8	nA
Input Noise Voltage (Note 2)	e_{npp}	0.1Hz to 10Hz		0.35	0.6		0.38	0.65		0.38	0.65	μV_{pp}
Input Noise Current (Note 2)	i_{npp}	0.1 Hz to 10Hz		14	30		15	35		15	35	pA _{pp}
Input Resistance-Differential-Mode	R_{in}	(Note 3)	26	45		18.5	45		18.5	45	M Ω	
Input Resistance-Common-Mode	R_{inCM}			200			200			200	G Ω	
Input Voltage Range	IVR		± 13	± 14		± 13	± 14		± 13	± 14	V	
Common-Mode Rejection Ratio	CMRR	$V_{CM} = \pm 13.0$		0.1	1.0		0.1	1.6		0.1	1.6	$\mu V/V$
Power Supply Rejection Ratio	PSRR	$V_s = \pm 3V$ to ± 18		0.7	3.0		0.7	3.0		0.7	3.0	$\mu V/V$
Large-Signal Voltage Gain	A_{VO}	$R_l \geq 2k\Omega$, $V_o = \pm 10V$	5000	12000		5000	6000		2000	6000	V/mV	
Output Voltage Swing	V_o	$R_l \geq 10k\Omega$	± 13.5	± 14.0		± 13.5	± 14.0		± 13.5	± 14.0	V	
Output Voltage Swing	V_o	$R_l \geq 2k\Omega$	12.5	± 13.0		± 12.5	± 13.0		± 12.5	± 13.0	V	
Output Voltage Swing	V_o	$R_l \geq 1k\Omega$	± 12.0	± 12.5		± 12.0	± 12.5		± 12.0	± 12.5	V	
Slewing Rate	SR	$R_l \geq 2k\Omega$	0.1	0.3		0.1	0.3		0.1	0.3	V/ μs	
Closed-Loop Bandwidth	BW	$A_{vcl} = +1.0$ (Note 1)	0.4	0.6		0.4	0.6		0.4	0.6	MHz	
Open-Loop Output Resistance	R_o	$V_o = 0$, $I_o = 0$		60			60			60	Ω	
Power Consumption	P_d	$V_s = \pm 15V$, No Load		50	60		50	60		50	60	mW
Power Consumption	P_d	$V_s = \pm 3V$, No Load		3.5	4.5		3.5	4.5		3.5	4.5	mW
Offset Adjustment Range		$R_p = 20k\Omega$		± 3			± 3			± 3		mV

Notes:

1. Long term input offset voltage stability refers to the averaged trend line of V_{os} vs. time over extended periods after the first 30 days of operation. Excluding the initial hour of operation, changes in V_{os} during the first 30 operating days are typically 2.5 mV.
2. Sample tested
3. Guaranteed by design.

OFFSET VOLTAGE TEST CIRCUIT

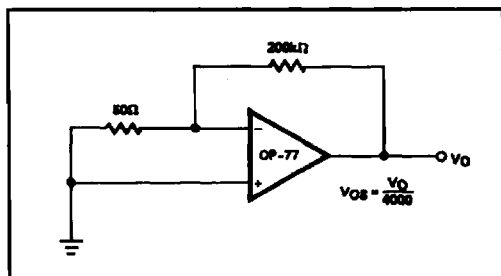

BURN-IN CIRCUIT

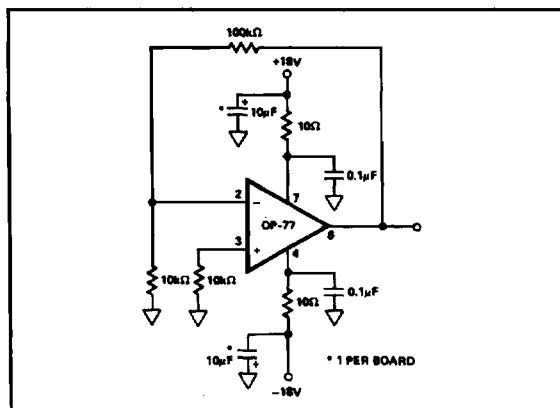

ELECTRICAL CHARACTERISTICS at $V_s = \pm 15V$, $-55^\circ C \leq T_a \leq +125^\circ C$, unless otherwise specified.

Parameter	Symbol	Conditions	OP-77A			OP-77B			Units
			Min.	Typ.	Max.	Min.	Typ.	Max.	
Input Offset Voltage	V_{os}			25	60		45	120	μV
Average Input Offset Voltage Drift	TCV_{os}	(Note 1)		0.1	0.3		0.2	0.6	$\mu V/^\circ C$ $\mu V/^\circ C$
Input Offset Current	I_{os}			0.5	2.2		0.5	4.5	nA
Average Input Offset Current Drift	TCI_{os}	Note 2		1.5	2.5		1.5	50	$\mu A/^\circ C$
Input Bias Current	I_B		0.2	2.4	4.0	0.2	2.4	6.0	nA
Average Input Bias Current Drift	TCI_B	Note 2		8	25		15	35	$\mu A/^\circ C$
Input Voltage Range	IVR		± 13	± 13.5		± 13	± 13.5		V
Common-Mode Rejection Ratio	CMRR	$V_{CM} \pm 13.0 V$		0.1	1.0		1.0	3	$\mu V/V$
Power Supply Rejection Ratio	PSRR	$V_s = \pm 3V$ to $\pm 18V$		1	3		1	5	$\mu V/V$
Large-Signal Voltage Gain	A_{vo}	$R_1 \geq 2\Omega$, $V_o = \pm 10V$	2080	6000		1000	4000		V/mV
Output Voltage Swing	V_o	$R_1 \geq 2\Omega$	± 12	± 13.0		± 12	± 13.0		V
Power Consumption	P_d	$V_s = 15kV$, No Load		60	75		60	75	mW

Notes:

1. OP-77; TCV_{os} is 100% tested.
2. Guaranteed by end point limits.

ELECTRICAL CHARACTERISTICS at $V_s = \pm 15V$, $-25^\circ C \leq T_a \leq +85^\circ C$, for OP-77/F/J, $0^\circ C \leq T_a \leq +70^\circ C$ for OP-77/F/GP and OP-77 /F/GS unless otherwise specified.

Parameter	Symbol	Conditions	OP-77E			OP-77F			OP-77G			Units
			Min.	Typ.	Max.	Min.	Typ.	Max.	Min.	Typ.	Max.	
Input Offset Voltage	V_{os}	J Package P Package		10 10	45 55		20 20	100 100		80	150	$\mu V/V$
Average Input Offset Voltage	TCV_{os}	J Package P Package		0.1 0.3	0.3 0.6		0.2 0.4	0.6 1.0				$\mu V/^\circ C$ $\mu V/^\circ C$
Input Offset Current	I_{os}			0.5	2.2		0.5	4.5		0.5	4.5	nA
Average Input Offset Current Drift	TCI_{os}	(Note 2)		1.5	4.0		1.5	80		1.5	85	$\mu A/^\circ C$
Input Bias Current	I_B		0.2	2.4	4.0	0.2	2.4	4.0	0.2	2.4	6.0	nA
Average Input Bias Current Drift	TCI_B	Note 2		8	40		15	60		15	60	$\mu A/^\circ C$
Input Voltage Range	IVR		± 13	± 13.5		± 13	± 13.5		± 13.0	± 13.5		V
Common Mode Rejection Ratio	CMRR	$V_{CM} \pm 13.0 V$		0.1	1.0		0.1	3.0		0.1	3.0	$\mu V/V$
Power Supply Rejection Ratio	PSRR	$V_s = \pm 3V$ to $\pm 18V$		1.0	3.0		1.0	5.0		1.0	5.0	$\mu V/V$
Large-Signal Voltage Gain	A_{vo}	$R_1 \geq 2\Omega$, $V_o = \pm 10V$	2000	6000		2000	6000		1000	4000		V/mV
Output Voltage Swing	V_o	$R_1 \geq 2\Omega$	± 12	± 13.0		± 12	± 13.0		± 12	± 13.0		V
Power Consumption	P_d	$V_s = 15kV$, No Load		60	75		60	75		60	75	mW

Notes:

1. OP-77; TCV_{os} is 100% tested on J packages
2. Guaranteed by end point limits.

TYPICAL PERFORMANCE

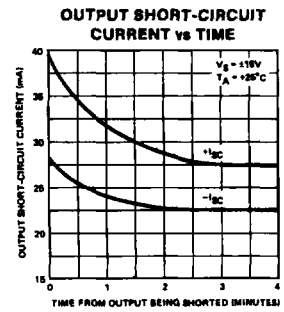
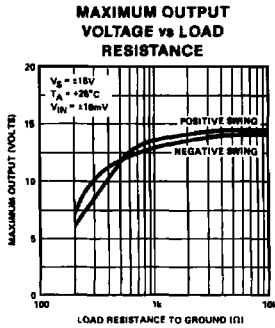
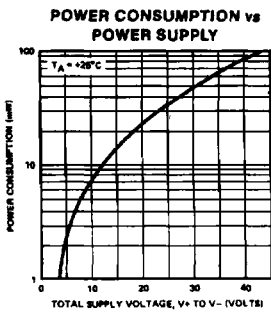
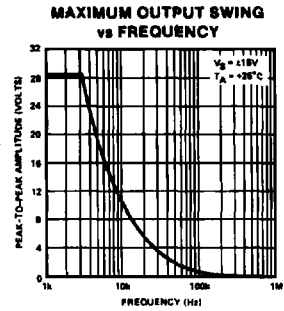
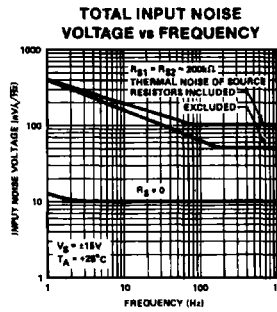
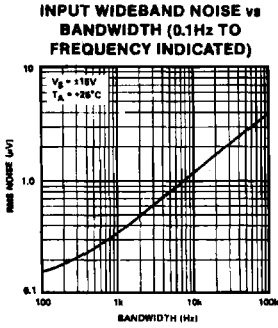
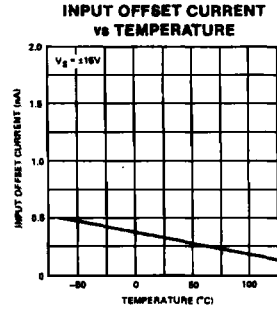
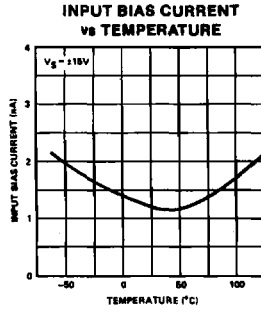
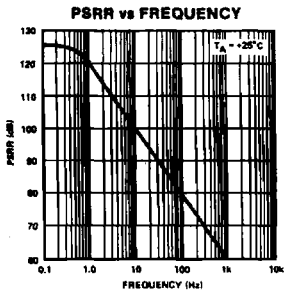

TYPICAL PERFORMANCE (continued)

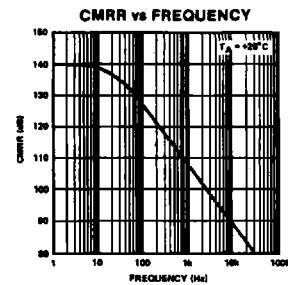
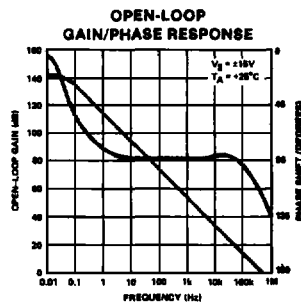
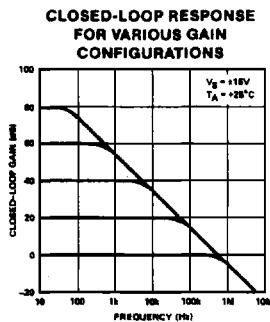
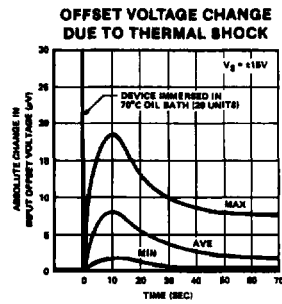
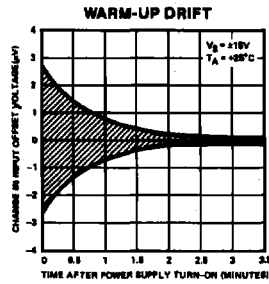
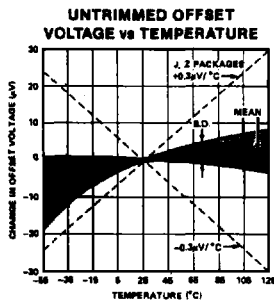
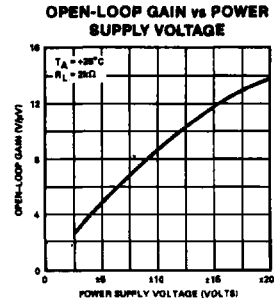
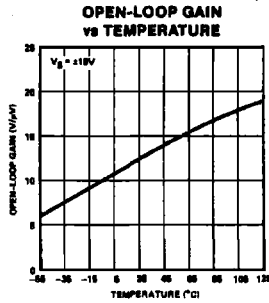
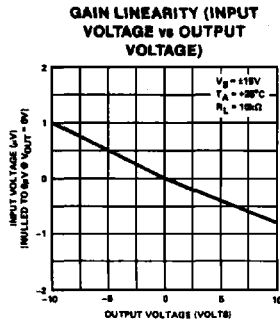

TYPICAL APPLICATIONS

LOW NOISE PRECISION REFERENCE

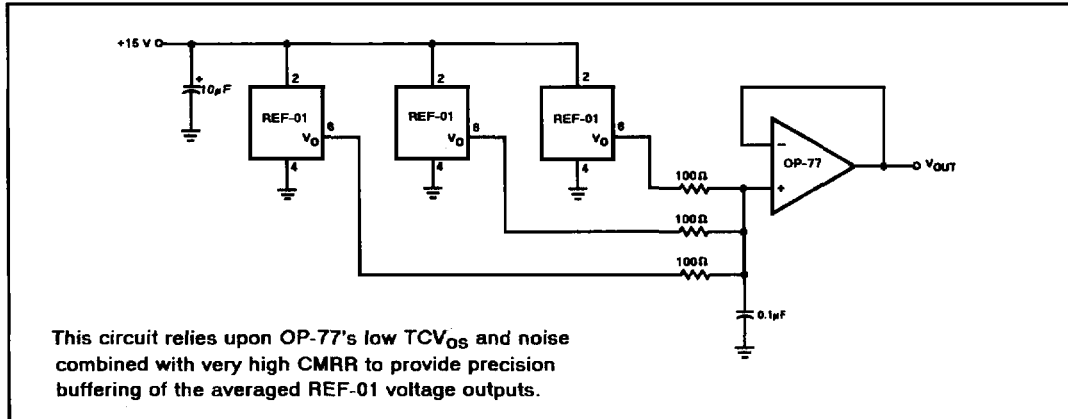

BILATERAL CURRENT SOURCE

