

*RoHS COMPLIANT

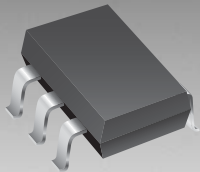

BOURNS®

Features

- RoHS compliant*
- Unidirectional & bidirectional configurations
- Protects 4 or 5 lines
- ESD, EFT & surge protection

Applications

- Cell phones
- PDAs and notebooks
- Digital cameras
- MP3 Players and GPS

CDSOT563-T05C – SMT TVS Diode Array

General Information

The CDSOT563-T05C device provides ESD and EFT protection for high speed data ports meeting IEC 61000-4-2 (ESD) and IEC 61000-4-4 (EFT) requirements. The Transient Voltage Suppressor array offers a Working Peak Reverse Voltage of 5 V.

The SOT563 packaged device will mount directly onto the industry standard SOT563 footprint. Bourns® Chip Diodes are easy to handle with standard pick and place equipment and the flat configuration minimizes roll away.

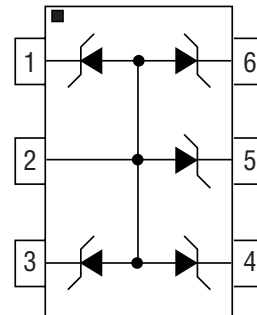

Electrical & Thermal Characteristics (@ T_A = 25 °C Unless Otherwise Noted)

Parameter	Symbol	CDSOT563-T05C	Unit
Peak Pulse Power (t _p = 8/20 μs) ^(NOTE 1)	P _{PK}	100	W
Peak Pulse Current (t _p = 8/20 μs)	I _{PPM}	9	A
Storage Temperature	T _{STG}	-55 to +150	°C
Operating Temperature	T _{OPR}	-55 to +150	°C
Minimum Breakdown Voltage @ 1 mA	V _{BR}	6	V
Maximum Working Peak Voltage	V _M	5	V
Maximum Clamping Voltage @ 8/20 μs @ I _{PP}	V _{PP}	12	V
Maximum Leakage Current @ V _{WM}	I _L	1	μA
Maximum Forward Voltage @ 10 mA	V _F	1	V
Typical Capacitance @ 0 V, 1 MHz	C _P	40	pF

Notes:

1. See Peak Pulse Power vs. Pulse Time.



Asia-Pacific:

Tel: +886-2 2562-4117 • Fax: +886-2 2562-4116

Europe:

Tel: +41-41 768 5555 • Fax: +41-41 768 5510

The Americas:

Tel: +1-951 781-5500 • Fax: +1-951 781-5700

www.bourns.com

*RoHS Directive 2002/95/EC Jan 27 2003 including Annex.

Specifications are subject to change without notice.

Customers should verify actual device performance in their specific applications.

CDSOT563-T05C – SMT TVS Diode Array



Product Dimensions

This is a molded JEDEC SOT-563 package with lead free 100 % Tin (Sn) on the lead frame. It weighs approximately 15 mg and has a flammability rating of UL 94V-0.

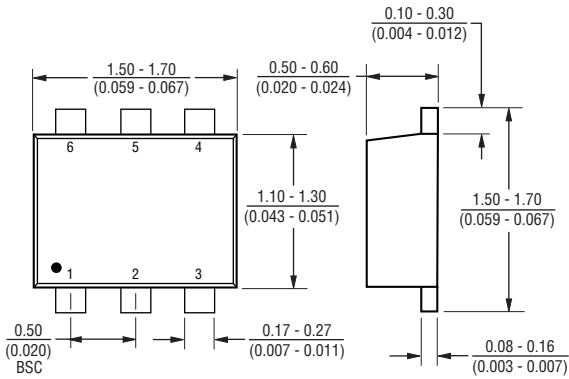

DIMENSIONS = $\frac{\text{MILLIMETERS}}{\text{(INCHES)}}$

Recommended Footprint

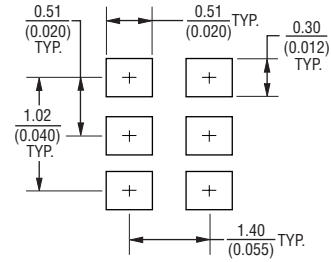

How To Order

Common Code CD SOT563 - T 05C

CD = Chip Diode

Package SOT563 = SOT-563 Package

Model T = Transient Voltage Suppressor Diode

Maximum Working Peak Voltage 05C = 5 V

Typical Part Marking

CDSOT563-T05CE5U

Performance Graphs

Peak Pulse Power vs Pulse Time

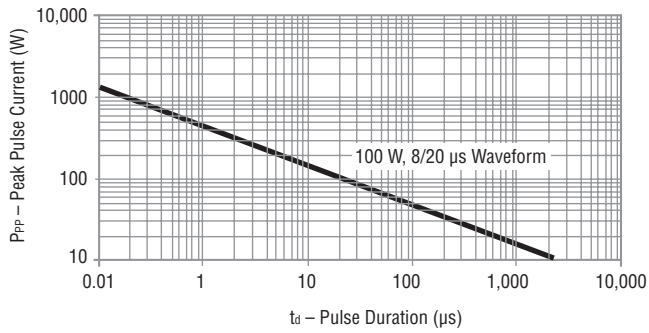

Pulse Waveform

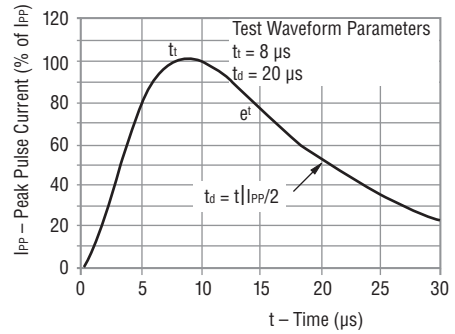

Overshoot & Clamping Voltage

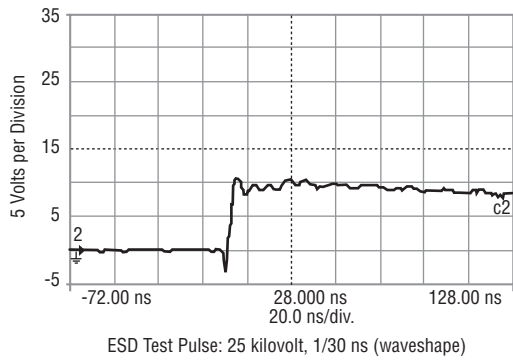

Power Derating Curve

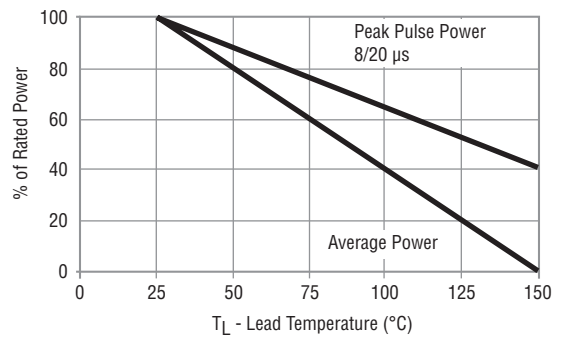

CDSOT563-T05C – SMT TVS Diode Array

BOURNS®

Packaging Information

The product will be dispensed in tape and reel format (see diagram below).

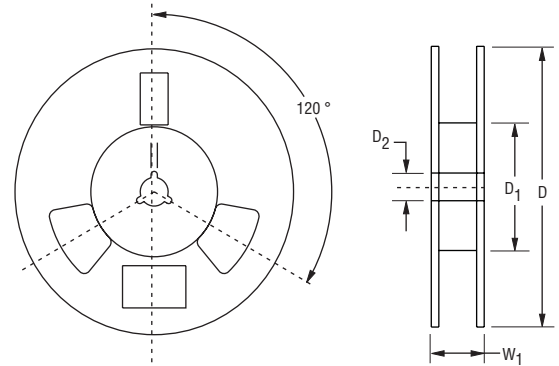
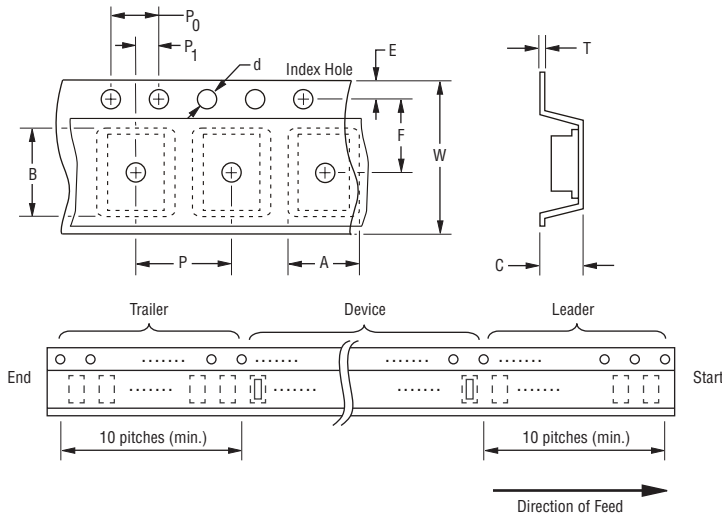

Devices are packed in accordance with EIA standard RS-481-A.

DIMENSIONS: $\frac{\text{MM}}{\text{(INCHES)}}$

Item	Symbol	SOT-563
Carrier Width	A	$\frac{1.78 \pm 0.005}{(0.069 \pm 0.002)}$
Carrier Length	B	$\frac{1.78 \pm 0.005}{(0.069 \pm 0.002)}$
Carrier Depth	C	$\frac{0.69 \pm 0.05}{(0.027 \pm 0.002)}$
Sprocket Hole	d	$\frac{1.55 \pm 0.05}{(0.061 \pm 0.002)}$
Reel Outside Diameter	D	$\frac{178}{(7.008)}$
Reel Inner Diameter	D ₁	$\frac{50.0}{(1.969)}$ MIN.
Feed Hole Diameter	D ₂	$\frac{13.0 \pm 0.20}{(0.512 \pm 0.008)}$
Sprocket Hole Position	E	$\frac{1.75 \pm 0.10}{(0.069 \pm 0.004)}$
Punch Hole Position	F	$\frac{3.50 \pm 0.05}{(0.138 \pm 0.002)}$
Punch Hole Pitch	P	$\frac{4.00 \pm 0.10}{(0.157 \pm 0.004)}$
Sprocket Hole Pitch	P ₀	$\frac{4.00 \pm 0.10}{(0.157 \pm 0.004)}$
Embossment Center	P ₁	$\frac{2.00 \pm 0.05}{(0.079 \pm 0.002)}$
Overall Tape Thickness	T	$\frac{0.20 \pm 0.10}{(0.008 \pm 0.004)}$
Tape Width	W	$\frac{8.00 \pm 0.20}{(0.315 \pm 0.008)}$
Reel Width	W ₁	$\frac{14.4}{(0.567)}$ MAX.
Quantity per Reel	--	3000

Specifications are subject to change without notice.
Customers should verify actual device performance in their specific applications.

REV. 04/09