

Photo Modules for PCM Remote Control Systems

Available Types For Different Carrier Frequencies

Type	Fo	Type	Fo
LTOP-4130	30 kHz	LTOP-4133	33 kHz
LTOP-4136	36 kHz	LTOP-4137	36.7 kHz
LTOP-4138	38 kHz	LTOP-4140	40 kHz
LTOP-4156	56 kHz		

Description

The LTOP-41.. – series are miniaturized receivers for infrared remote control systems. PIN diode and preamplifier are assembled on lead frame, the epoxy package is designed as IR filter.

The demodulated output signal can directly be decoded by a microprocessor. The main benefit is the reliable function even in disturbed ambient and the protection against uncontrolled output pulses.

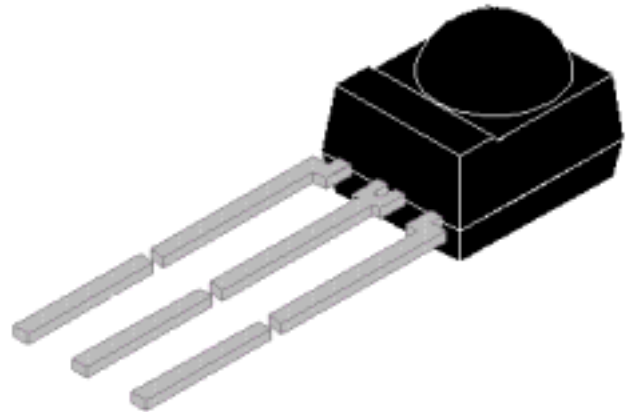

Features

- Photo detector and preamplifier in one package
- Internal filter for PCM frequency
- TTL and CMOS compatibility
- Output active low
- Improved shielding against electrical field disturbance
- Small size package
- High immunity against ambient light
- Enhanced data rate of 2400 bit/s
- Suitable burst length ≥ 6 cycle/burst

Applications

- TV sets
- Video recorders
- Sat receivers
- DVD
- Slide projectors
- Audio components
- Air conditioner
- Data communication
- Game equipment
- Sensors and light barrier systems for long distances

Block Diagram

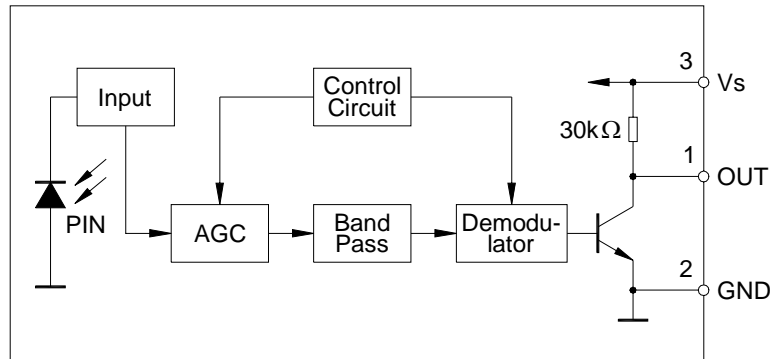

Absolute Maximum Ratings ($T_{amb}=25^{\circ}\text{C}$)

Parameter	Test Conditions	Symbol	Value	Unit
Supply Voltage	(Pin3)	V_s	-0.3...5.5	V
Supply Current	(Pin3)	I_s	5	mA
Output Voltage	(Pin1)	V_o	-0.3...5.5	V
Output Current	(Pin1)	I_o	5	mA
Junction Temperature		T_j	100	$^{\circ}\text{C}$
Storage temperature		T_{stg}	-25...+85	$^{\circ}\text{C}$
Operating temperature		T_{amb}	-25...+85	$^{\circ}\text{C}$
Power Consumption	($T_{amb}=25^{\circ}\text{C}$)	P_{tot}	30	mW
Soldering temperature	$t \leq 10s$, 1mm from case	T_{sd}	260	$^{\circ}\text{C}$

Basic Characteristics ($T_{amb}=25^{\circ}\text{C}$)

Parameter	Test conditions	Symbol	Min	Typ	Max	Unit
Supply current (Pin3)	$V_s=5V, E_v=0$	I_{SD}		1.2		mA
Supply voltage (Pin3)		V_s	2.7		5.5	V
Output voltage low (Pin 1)	$I_{osl}=0.5mA, E_e=0.7mW/m^2$	V_{OSL}			0.25	V
Transmission distance	$E_v=0$, test signal see fig 8, IR diode LTE-3371, $I_F=250mA$	L		35		m
Irradiance (30-40kHz)	Pulse width tolerance: $t_{pi}-5/fo < t_{po} < t_{pi}+5/fo$, test signal see fig.8	$E_e \text{ min}$		0.2	0.4	mW/m^2
Irradiance (56kHz)	Pulse width tolerance: $t_{pi}-5/fo < t_{po} < t_{pi}+5/fo$, test signal see fig.8	$E_e \text{ min}$		0.3	0.5	mW/m^2
Irradiance		$E_e \text{ max}$	30			W/m^2
Directivity(horizontal)	Angle of half transmission distance	$\phi_{H1/2}$		± 60		deg
Directivity(vertical)	Angle of half transmission distance	$\phi_{V1/2}$		± 45		deg

Application Circuit

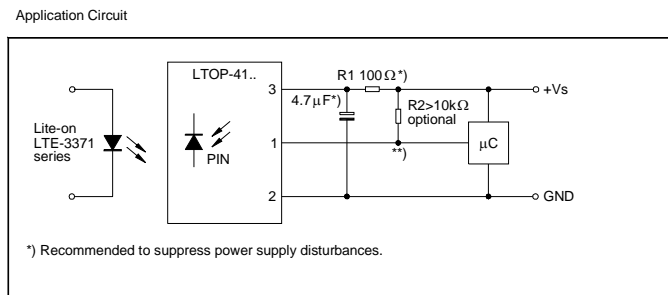

Suitable Data Format

The circuit of the LTOP-41.. is designed in that way that unexpected output pulses due to noise or disturbance signals are avoided. A bandpass filter, an integrator stage and an automatic gain control are used to suppress such disturbances.

The distinguishing marks between data signal and disturbance signal are carrier frequency, burst length and duty cycle.

The data signal should fulfill the following condition:

- Carrier frequency should be close to center frequency of the bandpass (e.g. 38kHz)
- Burst length should be 6 cycles/burst or longer
- After each burst which is between 6 cycles and 70 cycles a gap time of at least 10 cycles is necessary
- For each burst which is longer than 1.8ms a corresponding gap time is necessary at some time in the data stream. This gap time should be at least same length as the burst.

- Up to 2200 short bursts per second can be received continuously.

Some examples for suitable data format are: NEC Code, Toshiba Micom Format, Sharp Code, RC5 Code, RC6 Code, RCMM code R-2000 Code, RECS-80 code.

When a disturbance signal is applied to the LTOP-41.. it can still receive the data signal. However the sensitivity is reduced to that level that no unexpected pulses will occur.

Some examples for such disturbance signals which are suppressed by the LTOP-41.. are:

- DC light (e.g. from tungsten bulb or sunlight)
- Continuous signal at 38kHz or at any other frequency
- Signals from fluorescent lamps with electronic ballast (an example of the signal modulation is shown in figure below).

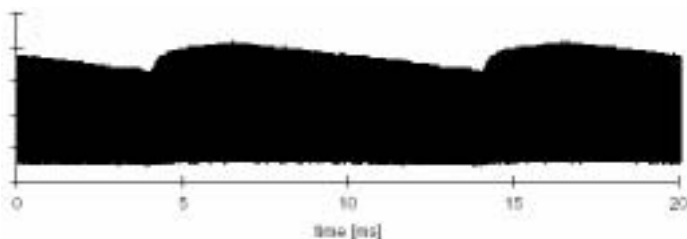

Figure A: IR Signal from Fluorescent Lamp with low Modulation

Typical Characteristics (T_{amb}=25 unless otherwise specified)

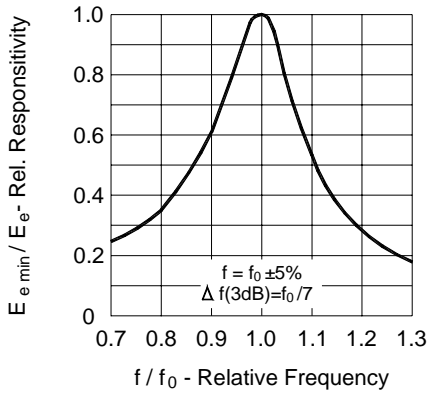

FIG.1 Frequency Dependence of Responsivity

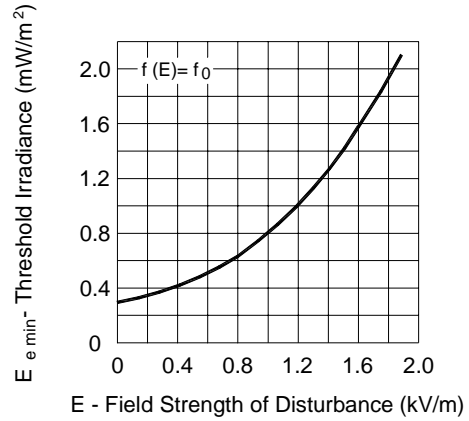

FIG.4 Sensitivity vs. Electric Field Disturbances

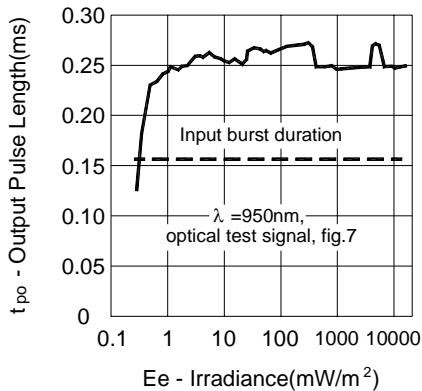

FIG.2 Sensitivity in Dark Ambient

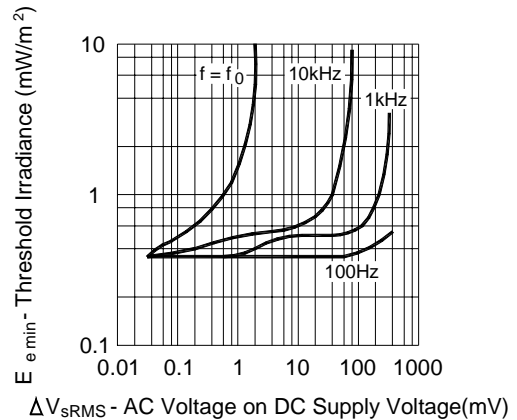

FIG.5 Sensitivity vs. Supply Voltage Disturbances

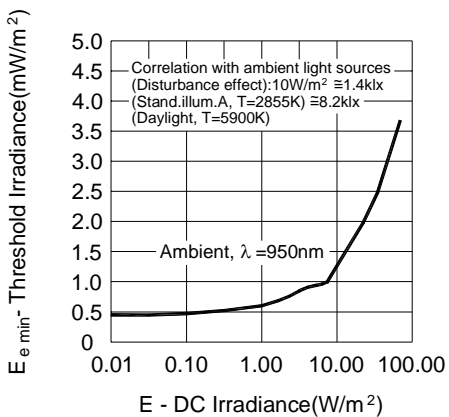

FIG.3 Sensitivity in Bright Ambient

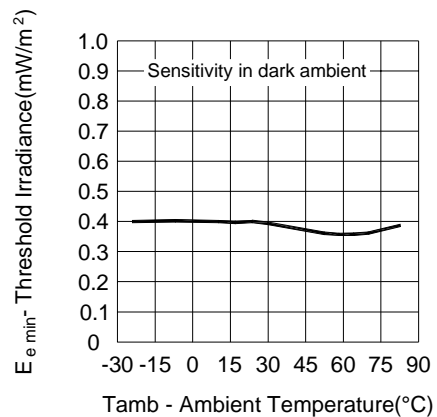

FIG.6 Sensitivity vs. Ambient Temperature

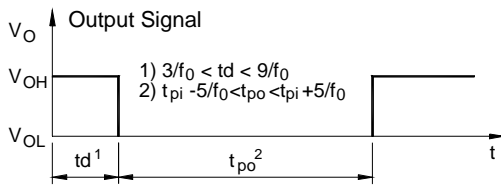
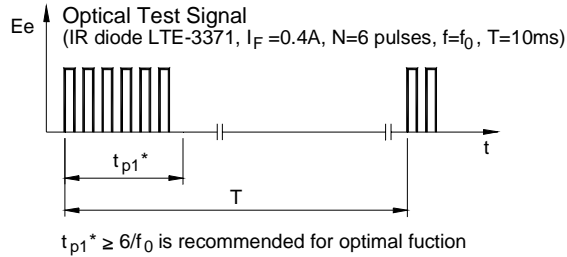

FIG.7 Output Function

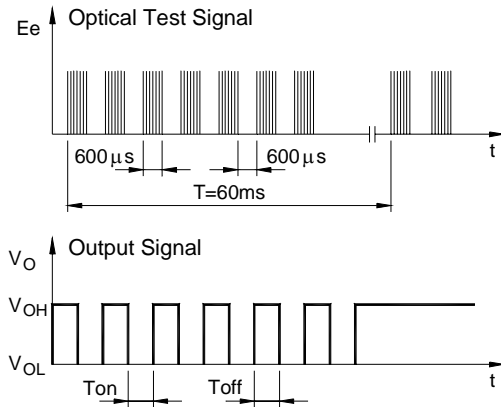

FIG.8 Output Function

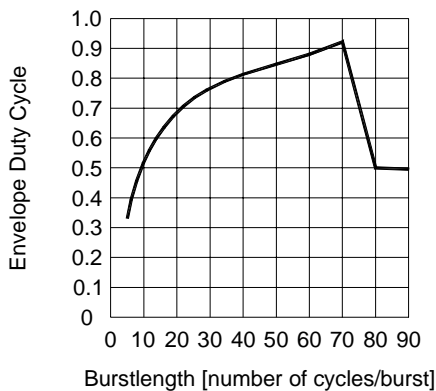

FIG.9 Max. Envelope Duty Cycle vs. Burstlength

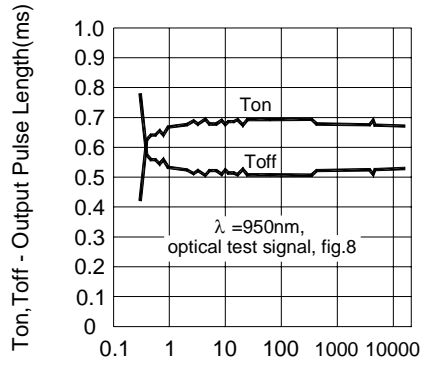

FIG.10 Output Pulse Diagram

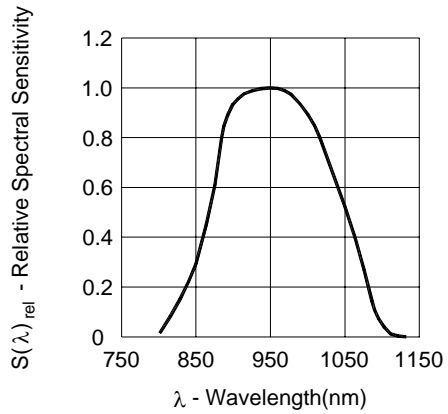

FIG.11 Relative Spectral Sensitivity vs. Wavelength

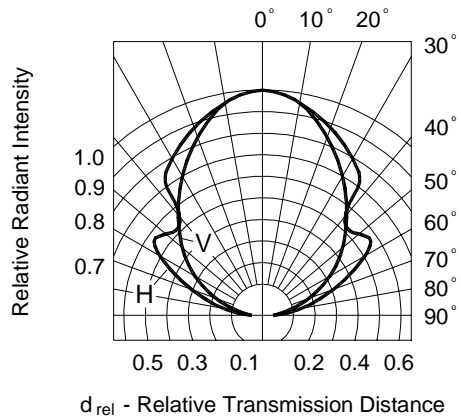
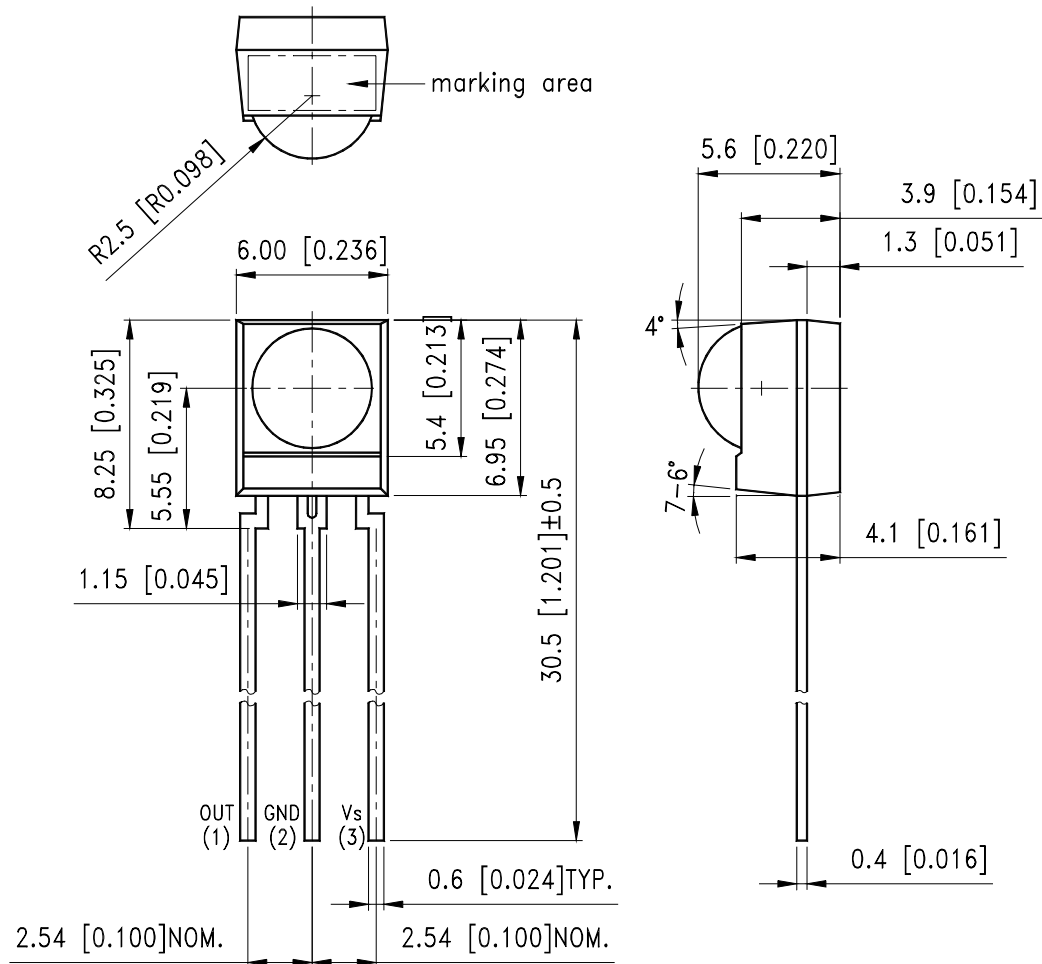

FIG.12 Directivity (V=vertical; H=horizontal)

Dimensions



NOTES:

1. All dimensions are in millimeters (inches).
2. Tolerance is : ±0.3mm (0.012") unless otherwise noted.

■ Reliability Test Items And Conditions

Test Items	Test Conditions	Failure Judgment Criteria	Samples(N) /Defective(C)
High Temperature Storage	Ta:85°C Test Time:1000hrs	Performance test requirement and criteria given in page 2 should be satisfied.	N=22 C=0
Low Temperature Storage	Ta:-25°C±5°C Test Time:1000hrs		N=22 C=0
Operation Life	Ta: 85°C Vcc=5V Test Time:240hrs		N=22 C=0
High Temp. & High Humid. Storage	Ta:40°C±5°C RH:90%±5 Test Time:240hrs		N=22 C=0
Temperature Cycling	-25°C~25°C~85°C~25°C 30min 5min 30min 5min Test Cycles: 20cycles		N=22 C=0
Vibration	10 to 55 Hz/sweep 1min Overall amplitude:1.5mm X,Y,Z direction, 2hrs each		N=11 C=0
Soldering Heat	T. Sol:260°C±5°C Dwell Time:5±1sec/ 2 times		N=11 C=0
Solderability	T. Sol:230°C±5°C Dwell Time:5±1sec		N=11 C=0
Lead Pull	Weight:500g, direction axial Test Time:30secs		N=11 C=0
Lead Bend	Weight:250g, bend each lead 0-90-0, 2 times		N=11 C=0
Mechanical shock	Weight:100g, 6ms/3 directions/3 times	N=11 C=0	

Product Designation And Selection Type Designation Code

