



# Single/Dual/Quad, Low-Cost, Single-Supply, Rail-to-Rail Op Amps with Shutdown

**MAX4400-MAX4403**

## General Description

The MAX4400–MAX4403 low-cost, general-purpose op amps offer Rail-to-Rail® outputs, draw only 320 $\mu$ A of quiescent current, and operate from a single +2.5V to +5.5V supply. For additional power conservation, the MAX4401 offers a low-power shutdown mode that reduces supply current to 1 $\mu$ A (max) and puts the amplifier's output in a high-impedance state. These devices deliver  $\pm$ 1.4mA of output current and are unity-gain stable with a 1MHz gain-bandwidth product driving capacitive loads up to 400pF. The MAX4400–MAX4403 are specified to +125°C, making them suitable for use in a variety of harsh environments, such as automotive applications.

The MAX4400 single amplifier is available in ultra-small 5-pin SC70 and space-saving 5-pin SOT23 packages. The single MAX4401 includes the shutdown feature and is available in a 6-pin SC70. The MAX4402 is a dual amplifier available in 8-pin SOT23 and SO packages. The MAX4403 quad amplifier is packaged in a 14-pin TSSOP or SO.

## Applications

Single-Supply, Zero-Crossing Detectors  
Instruments and Terminals  
Portable Communications  
Electronic Ignition Modules  
Infrared Receivers  
Sensor Signal Detection

## Selector Guide

PART	NO. OF AMPLIFIERS PER PACKAGE	SHUTDOWN MODE
MAX4400	1	No
MAX4401	1	Yes
MAX4402	2	No
MAX4403	4	No

Rail-to-Rail is a registered trademark of Nippon Motorola, Ltd.

## Features

- ◆ Single +2.5V to +5.5V Supply Voltage Range
- ◆ 320 $\mu$ A Quiescent Current per Amplifier
- ◆ 1 $\mu$ A (max) Shutdown Mode (MAX4401)
- ◆ Available in Space-Saving Packages
  - 5-Pin SC70 (MAX4400)
  - 6-Pin SC70 (MAX4401)
  - 8-Pin SOT23 (MAX4402)
- ◆ 110dB  $A_{VOL}$  with 2k $\Omega$  Load
- ◆ 0.015% THD with 2k $\Omega$  Load
- ◆ Rail-to-Rail Output Voltage Swing
- ◆ 1.4mA of Sink and Source Load Current
- ◆ Unity-Gain Stable up to  $C_{LOAD} = 400$ pF
- ◆ Ground-Sensing Inputs

## Ordering Information

PART	TEMP RANGE	PIN-PACKAGE	TOP MARK
MAX4400AXK-T	-40°C to +125°C	5 SC70-5	AAG
MAX4400AUK-T	-40°C to +125°C	5 SOT23-5	ADNP
MAX4401AXT-T	-40°C to +125°C	6 SC70-6	AAB
MAX4402AKA-T	-40°C to +125°C	8 SOT23-8	AADI
MAX4402AUA	-40°C to +125°C	8 $\mu$ MAX	—
MAX4402ASA	-40°C to +125°C	8 SO	—
MAX4403AUD	-40°C to +125°C	14 TSSOP	—
MAX4403ASD	-40°C to +125°C	14 SO	—

## Pin Configurations

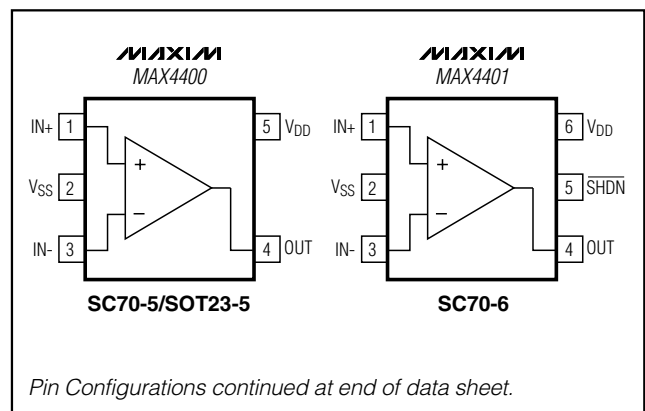

# Single/Dual/Quad, Low-Cost, Single-Supply, Rail-to-Rail Op Amps with Shutdown

## ABSOLUTE MAXIMUM RATINGS

Power-Supply Voltage ( $V_{DD}$ to $V_{SS}$ )	-0.3V to +6V	8-Pin SOT23 (derate 7.52mW/°C above +70°C)	602mW
All Other Pins	( $V_{SS} - 0.3V$ ) to ( $V_{DD} + 0.3V$ )	8-Pin $\mu$ MAX (derate 4.5mW/°C above +70°C)	362mW
Output Short-Circuit Duration		8-Pin SO (derate 5.88mW/°C above +70°C)	471mW
OUT Shorted to $V_{SS}$ or $V_{DD}$	Continuous	14-Pin TSSOP (derate 8.33mW/°C above +70°C)	667mW
Continuous Power Dissipation ( $T_A = +70^\circ\text{C}$ )		14-Pin SO (derate 8.33mW/°C above +70°C)	667mW
5-Pin SC70 (derate 2.5mW/°C above +70°C)	200mW	Operating Temperature Range	-40°C to +125°C
5-Pin SOT23 (derate 7.1mW/°C above +70°C)	571mW	Storage Temperature Range	-65°C to +150°C
6-Pin SC70 (derate 2.27mW/°C above +70°C)	181mW	Lead Temperature (soldering, 10s)	+300°C

Stresses beyond those listed under "Absolute Maximum Ratings" may cause permanent damage to the device. These are stress ratings only, and functional operation of the device at these or any other conditions beyond those indicated in the operational sections of the specifications is not implied. Exposure to absolute maximum rating conditions for extended periods may affect device reliability.

## ELECTRICAL CHARACTERISTICS

( $V_{DD} = +5V$ ,  $V_{SS} = 0$ ,  $V_{CM} = 0$ ,  $V_{OUT} = V_{DD}/2$ ,  $R_L = \infty$  connected to  $V_{DD}/2$ ,  $\overline{SHDN} = V_{DD}$  (MAX4401 only),  $T_A = +25^\circ\text{C}$ , unless otherwise noted.)

PARAMETER	SYMBOL	CONDITIONS	MIN	TYP	MAX	UNITS
Supply Voltage Range	$V_{DD}$	Inferred from PSRR test	2.5		5.5	V
Supply Current per Amplifier	$I_{DD}$	$V_{DD} = 2.5V$		320		$\mu\text{A}$
		$V_{DD} = 5.0V$		410	700	
Supply Current in Shutdown	$I_{SHDN}$	$\overline{SHDN} = V_{SS}$ (Note 1)		0.00002	1	$\mu\text{A}$
Input Offset Voltage	$V_{OS}$	MAX4400/MAX4401		$\pm 0.8$	$\pm 4.5$	mV
		MAX4402/MAX4403		$\pm 1.0$	$\pm 5.5$	
Input Bias Current	$I_B$	(Note 2)		$\pm 0.1$	$\pm 100$	pA
Input Offset Current	$I_{OS}$	(Note 2)		$\pm 0.1$	$\pm 100$	pA
Input Resistance	$R_{IN}$	Differential or common mode		1000		G $\Omega$
Input Common-Mode Voltage Range	$V_{CM}$	Inferred from CMRR test	$V_{SS}$		$V_{DD} - 1.4$	V
Common-Mode Rejection Ratio	CMRR	$V_{SS} \leq V_{CM} \leq V_{DD} - 1.4V$	68	84		dB
Power-Supply Rejection Ratio	PSRR	$2.5V \leq V_{DD} \leq 5.5V$	78	100		dB
Large-Signal Voltage Gain	$A_{VOL}$	$V_{SS} + 0.3V \leq V_{OUT} \leq V_{DD} - 0.3V$	$R_L = 100k\Omega$		120	dB
			$R_L = 2k\Omega$	90	110	
Output Voltage High	$V_{OH}$	Specified as $ V_{DD} - V_{OH} $	$R_L = 100k\Omega$		3	mV
			$R_L = 2k\Omega$		55	
Output Voltage Low	$V_{OL}$	Specified as $ V_{SS} - V_{OL} $	$R_L = 100k\Omega$		2	mV
			$R_L = 2k\Omega$		30	
Output Short-Circuit Current		Sourcing		12		mA
		Sinking		30		
Shutdown Mode Output Leakage	$I_{OUTSHDN}$	Device in shutdown mode, $\overline{SHDN} = V_{SS}$ , $V_{SS} < V_{OUT} < V_{CC}$ (Note 1)			$\pm 1.0$	$\mu\text{A}$
$\overline{SHDN}$ Logic Low	$V_{IL}$	(Note 1)			$0.3 \times V_{DD}$	V
$\overline{SHDN}$ Logic High	$V_{IH}$	(Note 1)	$0.7 \times V_{DD}$			V
$\overline{SHDN}$ Input Current	$I_{IL}, I_{IH}$	$\overline{SHDN} = V_{DD}$ or $V_{SS}$ (Note 1)		$\pm 0.001$	$\pm 500$	nA
Gain-Bandwidth Product	GBW			800		kHz
Phase Margin	$\phi_M$			70		degrees
Gain Margin				20		dB
Slew Rate	SR			1		V/ $\mu\text{s}$

# Single/Dual/Quad, Low-Cost, Single-Supply, Rail-to-Rail Op Amps with Shutdown

MAX4400-MAX4403

## ELECTRICAL CHARACTERISTICS (continued)

( $V_{DD} = +5V$ ,  $V_{SS} = 0$ ,  $V_{CM} = 0$ ,  $V_{OUT} = V_{DD}/2$ ,  $R_L = \infty$  connected to  $V_{DD}/2$ ,  $\overline{SHDN} = V_{DD}$  (MAX4401 only),  $T_A = +25^\circ\text{C}$ , unless otherwise noted.)

PARAMETER	SYMBOL	CONDITIONS		MIN	TYP	MAX	UNITS
Input Voltage Noise Density	$e_n$	$f = 10\text{kHz}$			36		$\text{nV}/\sqrt{\text{Hz}}$
Input Current Noise Density	$i_n$	$f = 10\text{kHz}$			1		$\text{fA}/\sqrt{\text{Hz}}$
Capacitive-Load Stability	$C_{LOAD}$	$A_V = +1V/V$			400		pF
Shutdown Delay Time	$t_{SHDN}$	(Note 1)			0.4		$\mu\text{s}$
Enable Delay Time	$t_{EN}$	(Note 1)			6		$\mu\text{s}$
Power-On Time	$t_{ON}$				5		$\mu\text{s}$
Input Capacitance	$C_{IN}$				2.5		pF
Total Harmonic Distortion	THD	$f = 10\text{kHz}$ , $V_{OUT} = 2V_{p-p}$ , $A_V = +1V/V$	$R_L = 100\text{k}\Omega$		0.009		%
			$R_L = 2\text{k}\Omega$		0.015		
Settling Time to 0.1%	$t_s$	$V_{OUT} = 2V$ step			7		$\mu\text{s}$

## ELECTRICAL CHARACTERISTICS

( $V_{DD} = +5V$ ,  $V_{SS} = 0$ ,  $V_{CM} = 0$ ,  $V_{OUT} = V_{DD}/2$ ,  $R_L = \infty$  connected to  $V_{DD}/2$ ,  $T_A = -40^\circ\text{C}$  to  $+125^\circ\text{C}$ , unless otherwise noted.) (Note 3)

PARAMETER	SYMBOL	CONDITIONS		MIN	TYP	MAX	UNITS
Supply Voltage Range	$V_{DD}$	Inferred from PSRR test		2.5		5.5	V
Supply Current per Amplifier	$I_{DD}$					800	$\mu\text{A}$
Input Offset Voltage	$V_{OS}$	MAX4400/MAX4401				$\pm 6.5$	mV
		MAX4402/MAX4403				$\pm 8.0$	
Input Offset Voltage Drift	$TC_{VOS}$				$\pm 1$		$\mu\text{V}/^\circ\text{C}$
Input Bias Current	$I_B$	(Note 2)				$\pm 100$	pA
Input Offset Current	$I_{OS}$	(Note 2)				$\pm 100$	pA
Input Common-Mode Voltage Range	$V_{CM}$	Inferred from CMRR test		$V_{SS}$		$V_{DD} - 1.5$	V
Common-Mode Rejection Ratio	CMRR	$V_{SS} \leq V_{CM} \leq V_{DD} - 1.5V$		65			dB
		$V_{SS} \leq V_{CM} \leq V_{DD} - 1.0V$ $T_A = -20^\circ\text{C}$ to $+125^\circ\text{C}$		50			
Power-Supply Rejection Ratio	PSRR	$2.5V \leq V_{CC} \leq 5.5V$		74			dB
Shutdown Mode Output Leakage	$I_{OUTSHDN}$	Device in shutdown mode, $\overline{SHDN} = V_{SS}$ , $V_{SS} < V_{OUT} < V_{DD}$ (Note 1)		$T_A = -40^\circ\text{C}$ to $+85^\circ\text{C}$		$\pm 1.0$	$\mu\text{A}$
				$T_A = +85^\circ\text{C}$ to $+125^\circ\text{C}$		$\pm 5.0$	
$\overline{SHDN}$ Logic Low	$V_{IL}$	(Note 1)				$0.3 \times V_{DD}$	V
$\overline{SHDN}$ Logic High	$V_{IH}$	(Note 1)				$0.7 \times V_{DD}$	V
$\overline{SHDN}$ Input Current	$I_{IL}$ , $I_{IH}$	$\overline{SHDN} = V_{DD}$ or $V_{SS}$ (Notes 1, 2)				$\pm 1000$	nA
Large-Signal Voltage Gain	$A_{VOL}$	$V_{SS} + 0.3V \leq V_{OUT} \leq V_{DD} - 0.3V$ , $R_L = 2\text{k}\Omega$		85			dB
Output Voltage High	$V_{OH}$	Specified as $I_{V_{DD}} - V_{OH}$ , $R_L = 2\text{k}\Omega$				250	mV
Output Voltage Low	$V_{OL}$	Specified as $I_{V_{SS}} - V_{OL}$ , $R_L = 2\text{k}\Omega$				100	mV

**Note 1:** Shutdown mode is only available in the 6-pin SC70 single op amp (MAX4401).

**Note 2:** Guaranteed by design.

**Note 3:** Specifications are 100% tested at  $T_A = +25^\circ\text{C}$  (exceptions noted). All temperature limits are guaranteed by design.

# Single/Dual/Quad, Low-Cost, Single-Supply, Rail-to-Rail Op Amps with Shutdown

## Typical Operating Characteristics

( $V_{DD} = +5V$ ,  $V_{SS} = 0$ ,  $V_{CM} = V_{DD}/2$ ,  $V_{SHDN} = 5V$ ,  $R_L = \infty$  connected to  $V_{DD}/2$ ,  $T_A = +25^\circ C$ , unless otherwise noted.)

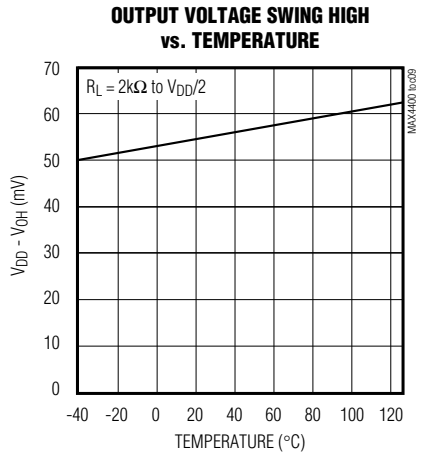
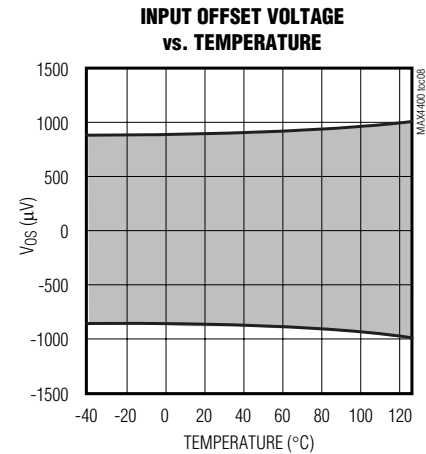
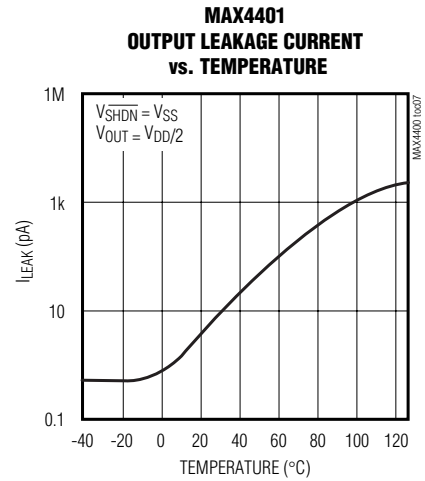
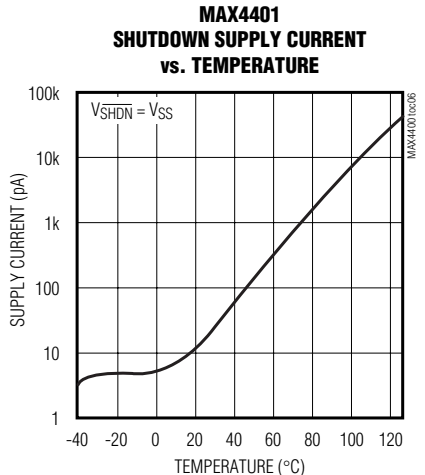
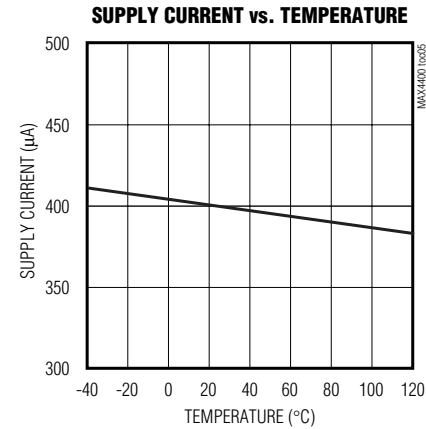
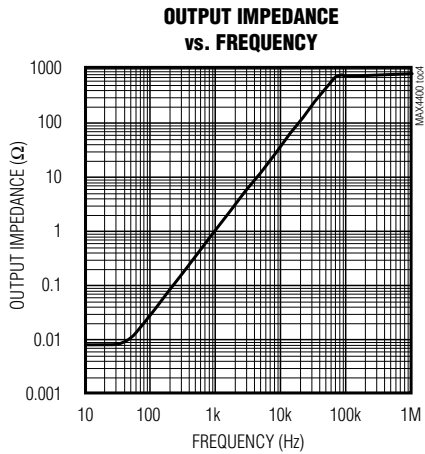
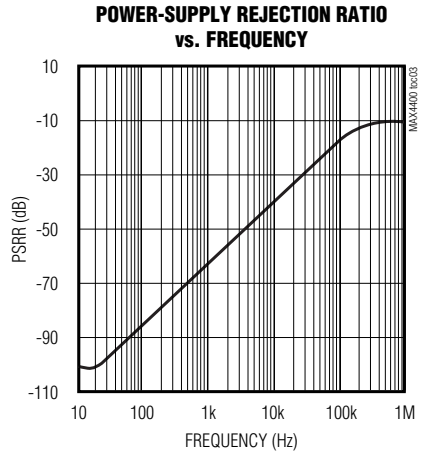
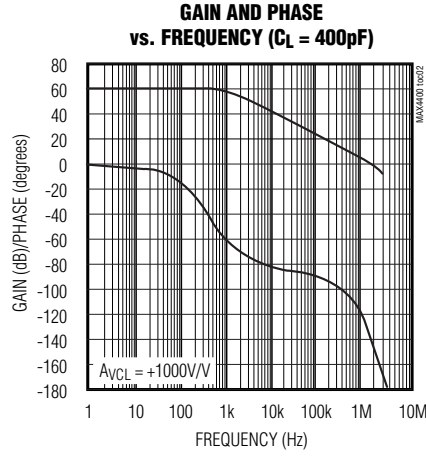
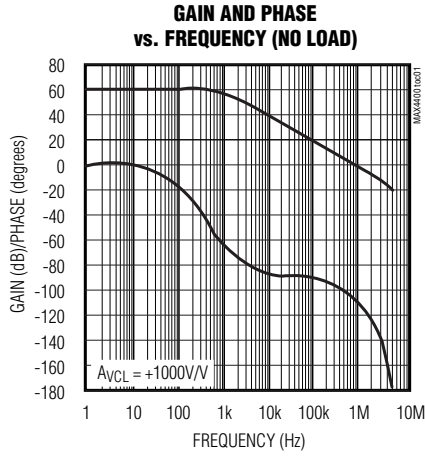

# Single/Dual/Quad, Low-Cost, Single-Supply, Rail-to-Rail Op Amps with Shutdown

MAX4400-MAX4403

## Typical Operating Characteristics (continued)

( $V_{DD} = +5V$ ,  $V_{SS} = 0$ ,  $V_{CM} = V_{DD}/2$ ,  $V_{SHDN} = 5V$ ,  $R_L = \infty$  connected to  $V_{DD}/2$ ,  $T_A = +25^\circ C$ , unless otherwise noted.)

**OUTPUT VOLTAGE SWING LOW vs. TEMPERATURE**

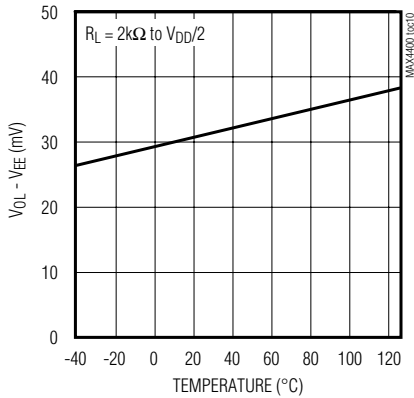

**COMMON-MODE REJECTION RATIO vs. TEMPERATURE**

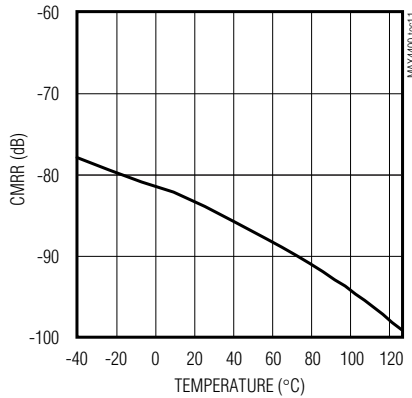

**LARGE-SIGNAL GAIN vs. OUTPUT VOLTAGE**

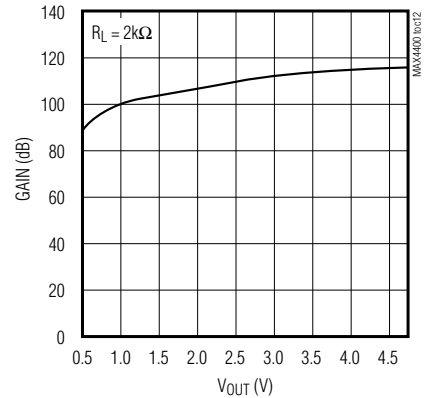

**LARGE-SIGNAL GAIN vs. TEMPERATURE**

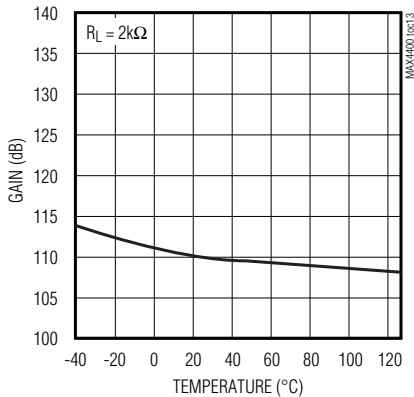

**MINIMUM OPERATING VOLTAGE vs. TEMPERATURE**

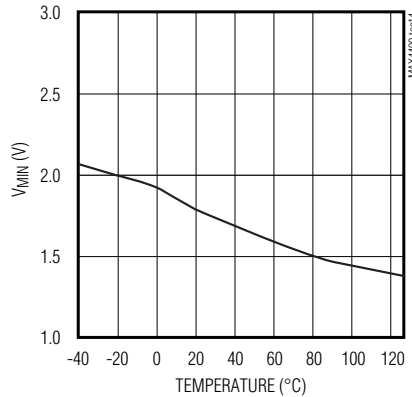

**TOTAL HARMONIC DISTORTION vs. FREQUENCY**

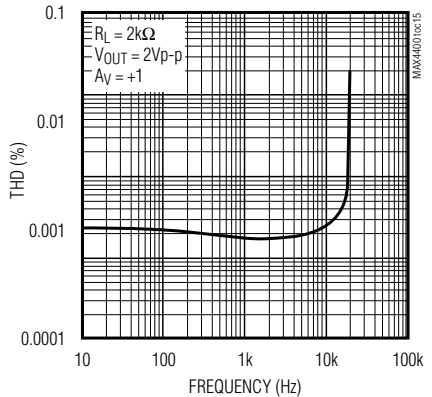

**TOTAL HARMONIC DISTORTION vs. FREQUENCY**

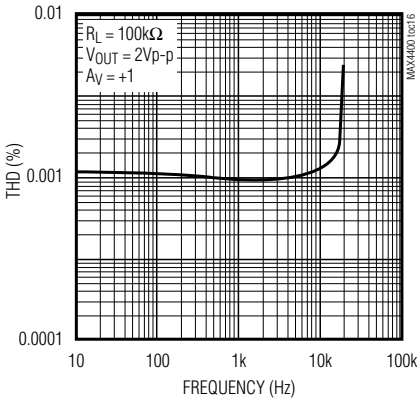

**TOTAL HARMONIC DISTORTION PLUS NOISE vs. INPUT AMPLITUDE**

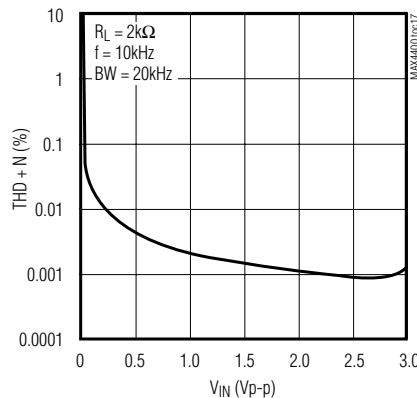

**TOTAL HARMONIC DISTORTION PLUS NOISE vs. INPUT AMPLITUDE**

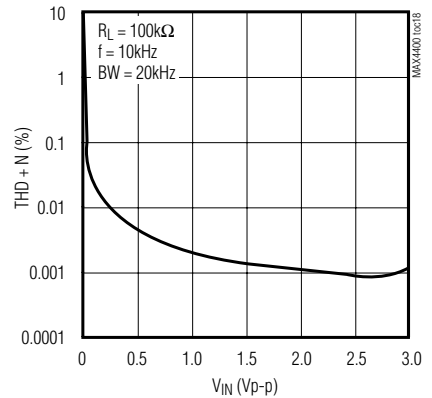

# Single/Dual/Quad, Low-Cost, Single-Supply, Rail-to-Rail Op Amps with Shutdown

## Typical Operating Characteristics (continued)

( $V_{DD} = +5V$ ,  $V_{SS} = 0$ ,  $V_{CM} = V_{DD}/2$ ,  $V_{SHDN} = 5V$ ,  $R_L = \infty$  connected to  $V_{DD}/2$ ,  $T_A = +25^\circ C$ , unless otherwise noted.)

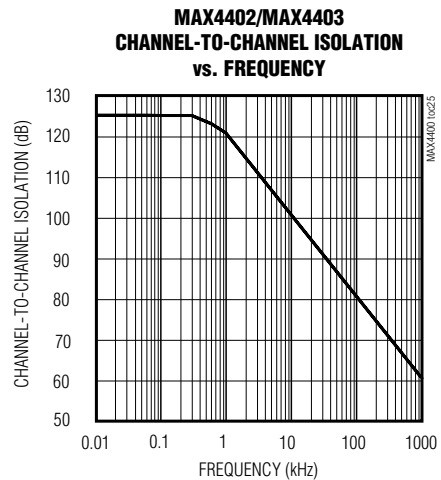
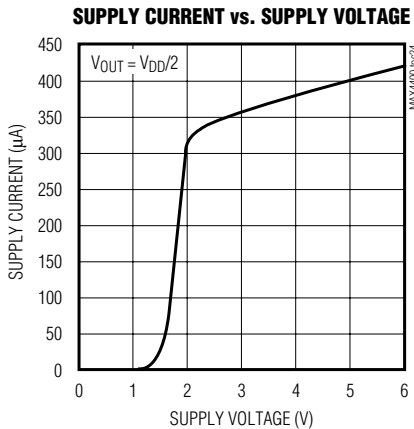
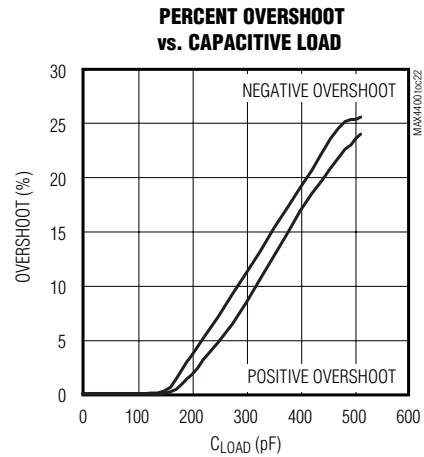
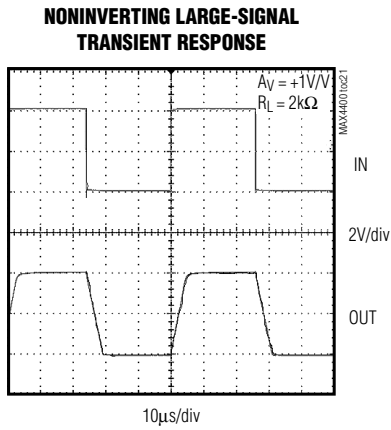
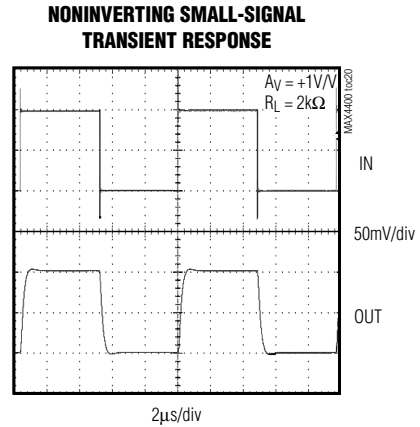
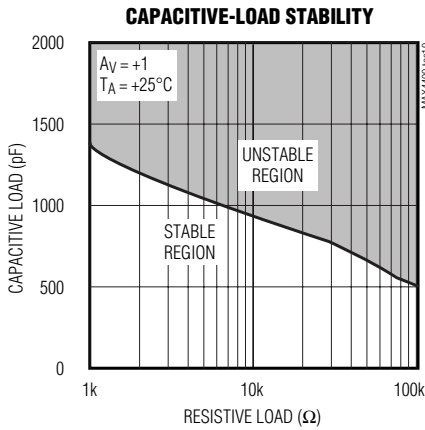

# Single/Dual/Quad, Low-Cost, Single-Supply, Rail-to-Rail Op Amps with Shutdown

MAX4400-MAX4403

## Pin Description

PIN				NAME	FUNCTION
MAX4400	MAX4401	MAX4402	MAX4403		
1	1	—	—	IN+	Noninverting Amplifier Input
—	—	3	3	INA+	Noninverting Amplifier Input A
—	—	5	5	INB+	Noninverting Amplifier Input B
—	—	—	10	INC+	Noninverting Amplifier Input C
—	—	—	12	IND+	Noninverting Amplifier Input D
2	2	4	11	V <sub>SS</sub>	Negative Supply. Connect to ground for single-supply operation
3	3	—	—	IN-	Inverting Amplifier Input
—	—	2	2	INA-	Inverting Amplifier Input A
—	—	6	6	INB-	Inverting Amplifier Input B
—	—	—	9	INC-	Inverting Amplifier Input C
—	—	—	13	IND-	Inverting Amplifier Input D
4	4	—	—	OUT	Amplifier Output
—	—	1	1	OUTA	Amplifier Output A
—	—	7	7	OUTB	Amplifier Output B
—	—	—	8	OUTC	Amplifier Output C
—	—	—	14	OUTD	Amplifier Output D
5	6	8	4	V <sub>DD</sub>	Positive Supply
—	5	—	—	$\overline{\text{SHDN}}$	Active-Low Shutdown Input. Connect to V <sub>DD</sub> for normal operation. Do not leave floating.

## Detailed Description

### Rail-to-Rail Output Stage

The MAX4400–MAX4403 can drive a 2k $\Omega$  load and still typically swing within 55mV of the supply rails. Figure 1 shows the output voltage swing of the MAX4400 configured with A<sub>v</sub> = +10V/V.

### Driving Capacitive Loads

Driving a capacitive load can cause instability in many op amps, especially those with low quiescent current. The MAX4400–MAX4403 are unity-gain stable for a range of capacitive loads to above 400pF. Figure 2 shows the response of the MAX4400 with an excessive capacitive load. Adding a series resistor between the output and the load capacitor (Figure 3) improves the

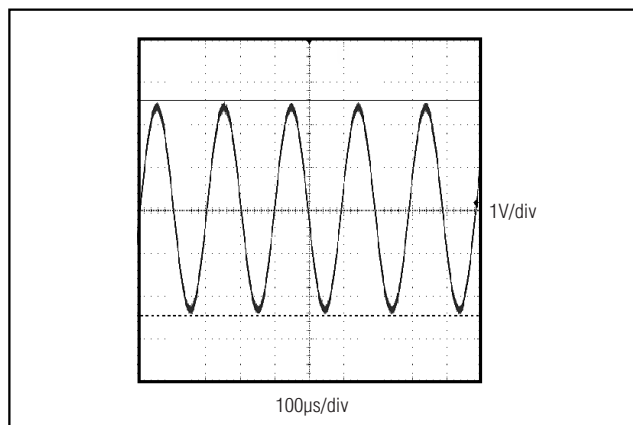

Figure 1. Rail-to-Rail Output Operation

# Single/Dual/Quad, Low-Cost, Single-Supply, Rail-to-Rail Op Amps with Shutdown

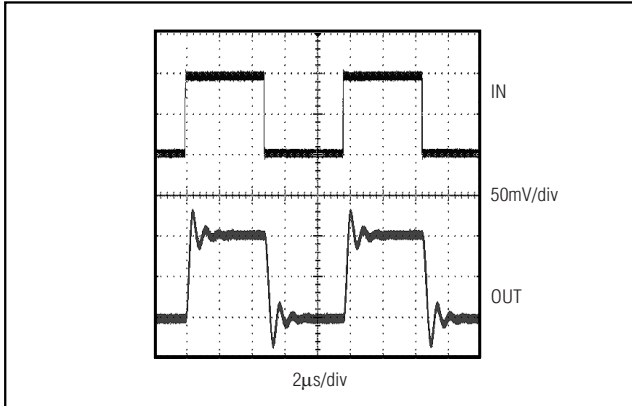

Figure 2. Small-Signal Transient Response with Excessive Capacitive Load

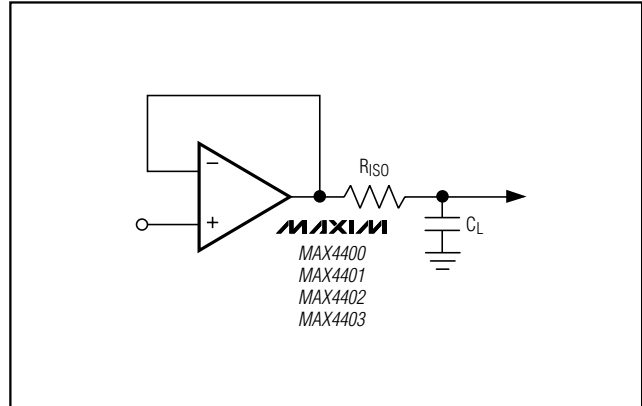

Figure 3. Capacitive-Load-Driving Circuit

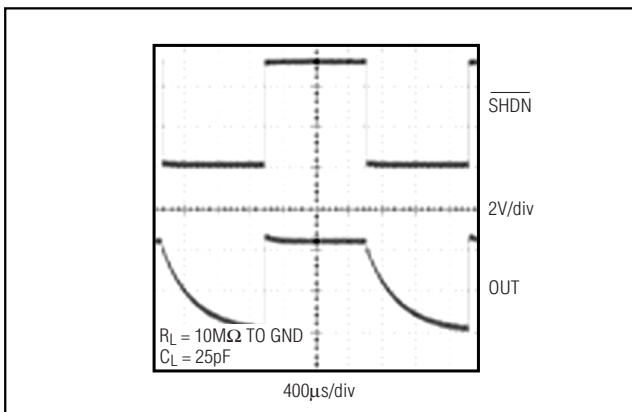

Figure 4. Shutdown Waveform

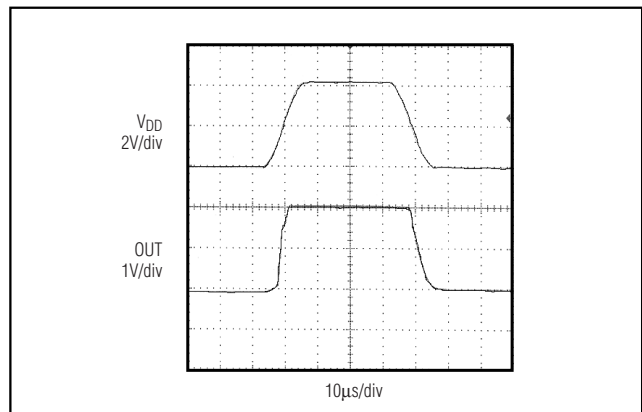

Figure 5. Power-Up/Power-Down Waveform

circuit's response by isolating the load capacitance from the op amp's output.

## Applications Information

### Shutdown Mode

The MAX4401 features a low-power shutdown mode. When  $\overline{\text{SHDN}}$  goes low, the supply current drops to 20pA (typ) and the output enters a high-impedance state. Pull  $\overline{\text{SHDN}}$  high to enable the amplifier. Do not leave  $\overline{\text{SHDN}}$  floating. Figure 4 shows the shutdown waveform.

### Power-Up

The MAX4400-MAX4403 outputs typically settle within 5µs after power-up. Figure 5 shows the output voltage on power-up and power-down.

### Power Supplies and Layout

The MAX4400-MAX4403 operate from a single +2.5V to +5.5V power supply. Bypass the power supply with a 0.1µF capacitor to ground.

Good layout techniques optimize performance by decreasing the amount of stray capacitance at the op amp's inputs and outputs. To decrease stray capacitance, minimize trace lengths by placing external components close to the op amp's pins.

### Chip Information

MAX4400/MAX4401 TRANSISTOR COUNT: 101  
 MAX4402 TRANSISTOR COUNT: 202  
 MAX4403 TRANSISTOR COUNT: 404



# Single/Dual/Quad, Low-Cost, Single-Supply, Rail-to-Rail Op Amps with Shutdown

## Pin Configurations (continued)

**MAX4400-MAX4403**

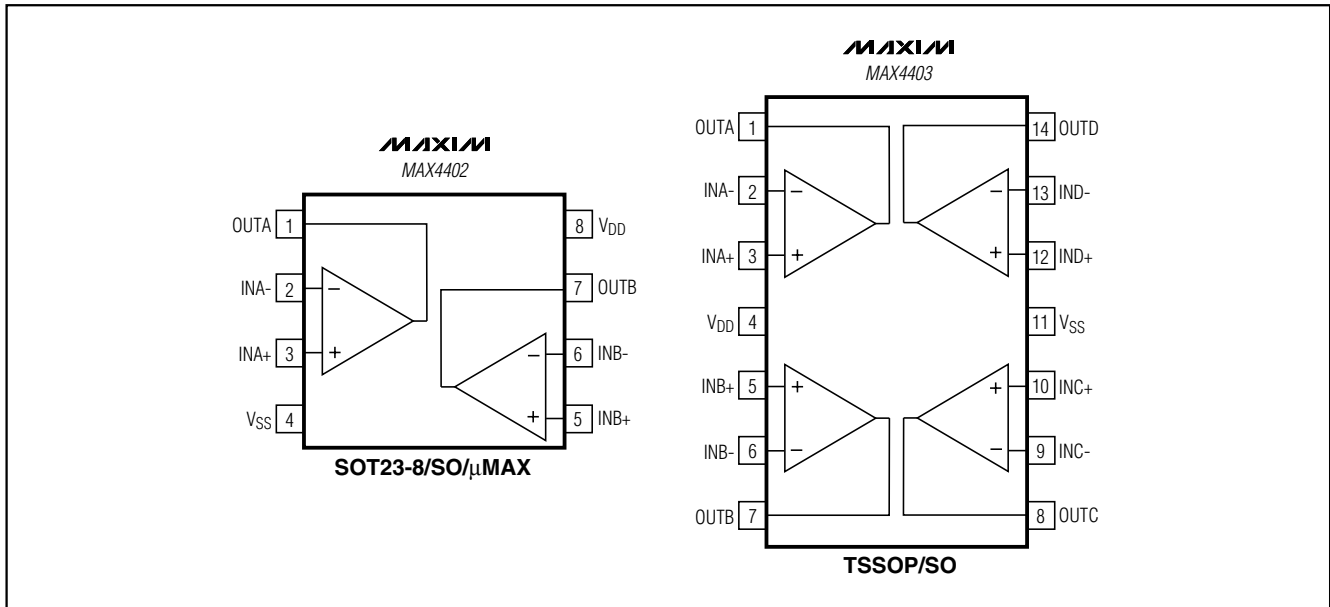

## Package Information

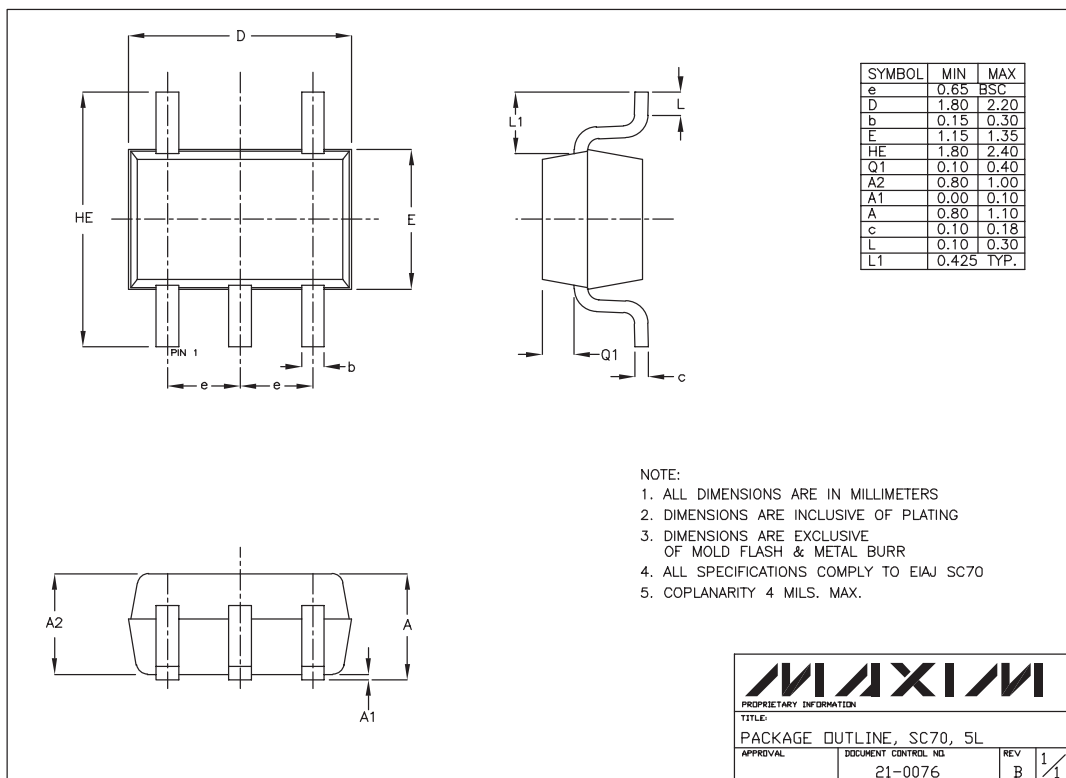

SC70, 5L EPS

# Single/Dual/Quad, Low-Cost, Single-Supply, Rail-to-Rail Op Amps with Shutdown

## Package Information (continued)

SYMBOL	MIN	MAX
e	0.65	BSC
D	1.80	2.20
b	0.15	0.30
E	1.15	1.35
HE	1.80	2.40
Q1	0.10	0.40
A2	0.80	1.00
A1	0.00	0.10
A	0.80	1.10
c	0.10	0.18
L	0.10	0.30
L1	0.425	TYP.

PIN 1 DOT (SEE NOTE 6)

PIN 1

L1

L

Q1

c

A2

A

A1

1. ALL DIMENSIONS ARE IN MILLIMETERS
2. DIMENSIONS ARE INCLUSIVE OF PLATING
3. DIMENSIONS ARE EXCLUSIVE OF MOLD FLASH & METAL BURR
4. ALL SPECIFICATIONS COMPLY TO EIAJ SC70
5. COPLANARITY 4 MILS. MAX.
6. PIN 1 I.D. DOT

SC70, 6L, EPS

<small>PROPRIETARY INFORMATION</small> <small>TITLE:</small> PACKAGE OUTLINE, SC70, 6L		
<small>APPROVAL:</small>	<small>DOCUMENT CONTROL NO.:</small> 21-0077	<small>REV</small> B $\frac{1}{1}$

# Single/Dual/Quad, Low-Cost, Single-Supply, Rail-to-Rail Op Amps with Shutdown

## Package Information (continued)

**MAX4400-MAX4403**

SOT23LEFS

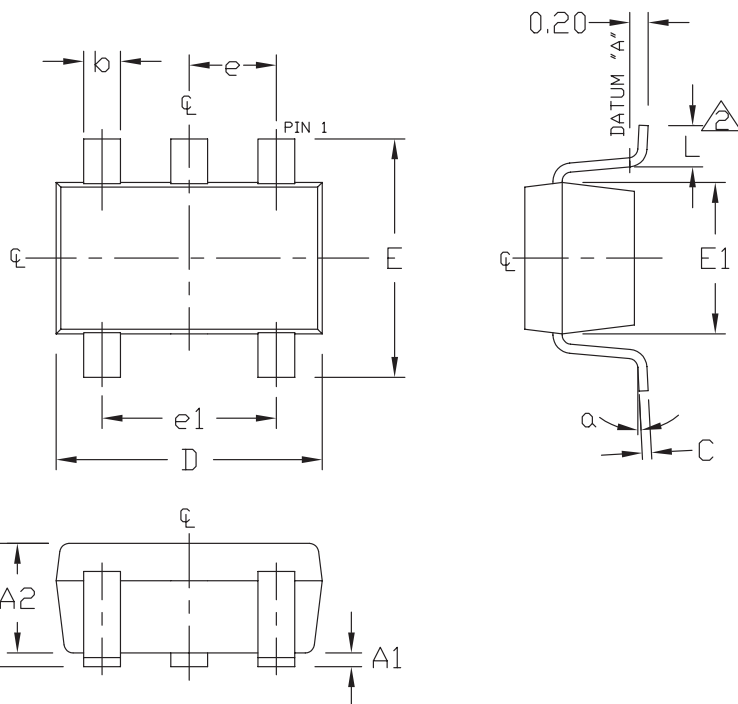

SYMBOL	MIN	MAX
A	0.90	1.45
A1	0.00	0.15
A2	0.90	1.30
b	0.35	0.50
C	0.08	0.20
D	2.80	3.00
E	2.60	3.00
E1	1.50	1.75
L	0.35	0.55
e	0.95 REF	
e1	1.90 REF	
a	0°	10°

**NOTES:**

1. ALL DIMENSIONS ARE IN MILLIMETERS.
2. FOOT LENGTH MEASURED AT INTERCEPT POINT BETWEEN DATUM A & LEAD SURFACE.
3. PACKAGE OUTLINE EXCLUSIVE OF MOLD FLASH & METAL BURR.
4. PACKAGE OUTLINE INCLUSIVE OF SOLDER PLATING.
5. MEETS JEDEC MO178.

<b>MAXIM</b>		
<small>PROPRIETARY INFORMATION</small>		
<small>TITLE:</small>		
PACKAGE OUTLINE, SOT-23, 5L		
<small>APPROVAL</small>	<small>DOCUMENT CONTROL NO.</small>	<small>REV</small>
	21-0057	C 1/1

# Single/Dual/Quad, Low-Cost, Single-Supply, Rail-to-Rail Op Amps with Shutdown

## Package Information (continued)

SYMBOL	MIN	MAX
A	0.90	1.45
A1	0.00	0.15
A2	0.90	1.30
b	0.28	0.45
C	0.09	0.20
D	2.80	3.00
E	2.60	3.00
E1	1.50	1.75
L	0.10	0.60
e	0.65 ref	
e1	1.95 ref	
α	0°	10°

NOTE:  
 1. ALL DIMENSIONS ARE IN MILLIMETERS.  
 2. FOOT LENGTH MEASURED REFERENCE TO FLAT FOOT SURFACE PARALLEL TO DATUM "A".  
 3. PACKAGE OUTLINE EXCLUSIVE OF MOLD FLASH & METAL BURR.  
 4. PACKAGE OUTLINE INCLUSIVE OF SOLDER PLATING.  
 5. EIAJ REF. NUMBER SC-74 (6 LEAD VERSION)  
 6. COPLANARITY 4 MILS. MAX.  
 7. PIN 1 I.D. DOT IS 0.3 MM Ø MIN. LOCATED ABOVE PIN 1.  
 8. MEETS JEDEC MO178.

SOT23, 8LEPS

<b>MAXIM</b>		
PROPRIETARY INFORMATION		
TITLE: PACKAGE OUTLINE, SOT-23, 8L		
APPROVAL	DOCUMENT CONTROL NO. 21-0078	REV C 1/1

Maxim cannot assume responsibility for use of any circuitry other than circuitry entirely embodied in a Maxim product. No circuit patent licenses are implied. Maxim reserves the right to change the circuitry and specifications without notice at any time.

12 \_\_\_\_\_ **Maxim Integrated Products, 120 San Gabriel Drive, Sunnyvale, CA 94086 408-737-7600**



SITE  
SEARCH
PART NO.  
SEARCH

WHAT'S NEW

PRODUCTS

SOLUTIONS

DESIGN

APPNOTES

SUPPORT

BUY

COMPANY

MEMBERS

## MAX4402

### Part Number Table

#### Notes:

1. See the [MAX4402 QuickView Data Sheet](#) for further information on this product family or download the [MAX4402 full data sheet](#) (PDF, 384kB).
2. Other options and links for purchasing parts are listed at: <http://www.maxim-ic.com/sales>.
3. [Didn't Find What You Need?](#) Ask our applications engineers. Expert assistance in finding parts, usually within one business day.
4. Part number suffixes: T or T&R = tape and reel; + = RoHS/lead-free; # = RoHS/lead-exempt. More: See [full data sheet](#) or [Part Naming Conventions](#).
5. \* Some packages have variations, listed on the drawing. "PkgCode/Variation" tells which variation the product uses.

Part Number	Free Sample	Buy Direct	Package: TYPE PINS SIZE DRAWING CODE/VAR *	Temp	RoHS/Lead-Free? Materials Analysis
MAX4402ASA	<input type="checkbox"/>	<input type="checkbox"/>	SOIC;8 pin;.150" Dwg: <a href="#">21-0041B</a> (PDF) Use pkgcode/variation: S8-2*	-40C to +125C	RoHS/Lead-Free: <a href="#">No Materials Analysis</a>
MAX4402ASA-T	<input type="checkbox"/>	<input type="checkbox"/>	SOIC;8 pin;.150" Dwg: <a href="#">21-0041B</a> (PDF) Use pkgcode/variation: S8-2*	-40C to +125C	RoHS/Lead-Free: <a href="#">No Materials Analysis</a>
MAX4402ASA+T	<input type="checkbox"/>	<input type="checkbox"/>	SOIC;8 pin;.150" Dwg: <a href="#">21-0041B</a> (PDF) Use pkgcode/variation: S8+2*	-40C to +125C	RoHS/Lead-Free: <a href="#">Yes Materials Analysis</a>
MAX4402ASA+	<input type="checkbox"/>	<input type="checkbox"/>	SOIC;8 pin;.150" Dwg: <a href="#">21-0041B</a> (PDF) Use pkgcode/variation: S8+2*	-40C to +125C	RoHS/Lead-Free: <a href="#">Yes Materials Analysis</a>
MAX4402AKA	<input type="checkbox"/>	<input type="checkbox"/>	SOT-23;8 pin; Dwg: <a href="#">21-0078F</a> (PDF) Use pkgcode/variation: K8-5*	-40C to +125C	RoHS/Lead-Free: <a href="#">No Materials Analysis</a>
MAX4402AKA+	<input type="checkbox"/>	<input type="checkbox"/>	SOT-23;8 pin; Dwg: <a href="#">21-0078F</a> (PDF) Use pkgcode/variation: K8+5*	-40C to +125C	RoHS/Lead-Free: <a href="#">Yes Materials Analysis</a>
MAX4402AKA+T	<input type="checkbox"/>	<input type="checkbox"/>	SOT-23;8 pin; Dwg: <a href="#">21-0078F</a> (PDF) Use pkgcode/variation: K8+5*	-40C to +125C	RoHS/Lead-Free: <a href="#">Yes Materials Analysis</a>

MAX4402AKA-T			SOT-23;8 pin; Dwg: <a href="#">21-0078F</a> (PDF) Use pkgcode/variation: K8-5*	-40C to +125C	RoHS/Lead-Free: <a href="#">No Materials Analysis</a>
MAX4402AUA+			uMAX;8 pin;3 x 3mm Dwg: <a href="#">21-0036J</a> (PDF) Use pkgcode/variation: U8+1*	-40C to +125C	RoHS/Lead-Free: <a href="#">Yes Materials Analysis</a>
MAX4402AUA-T			uMAX;8 pin;3 x 3mm Dwg: <a href="#">21-0036J</a> (PDF) Use pkgcode/variation: U8-1*	-40C to +125C	RoHS/Lead-Free: <a href="#">No Materials Analysis</a>
MAX4402AUA			uMAX;8 pin;3 x 3mm Dwg: <a href="#">21-0036J</a> (PDF) Use pkgcode/variation: U8-1*	-40C to +125C	RoHS/Lead-Free: <a href="#">No Materials Analysis</a>
MAX4402AUA+T			uMAX;8 pin;3 x 3mm Dwg: <a href="#">21-0036J</a> (PDF) Use pkgcode/variation: U8+1*	-40C to +125C	RoHS/Lead-Free: <a href="#">Yes Materials Analysis</a>

[Didn't Find What You Need?](#)

[CONTACT US: SEND US AN EMAIL](#)