

OP-27

Low Noise Operational Amplifier

Features

- Very low noise
 - Spectral noise density — 3.0 nV/Hz
 - 1/f noise corner frequency — 2.7 Hz
- Very low V_{os} drift
 - 0.2 $\mu\text{V}/\text{Mo}$
 - 0.2 $\mu\text{V}/^\circ\text{C}$
- High gain — $1.8 \times 10^6 \text{ V/V}$
- High output drive capability — $\pm 12\text{V}$ into 600 load
- High slew rate — 2.8 $\text{V}/\mu\text{S}$
- Wide gain bandwidth product — 8 MHz
- Good common mode rejection ratio — 126 dB
- Low input offset voltage — 10 μV
- Minimum low frequency noise — 0.08 $\mu\text{V}_{\text{p-p}}$ 0.1 Hz to 10 Hz
- Low input bias and offset currents — 10 nA

Description

The OP-27 is designed for instrumentation grade signal conditioning where low noise (both spectral density and burst), wide bandwidth, and high slew rate are required along with low input offset voltage, low input offset temperature

coefficient, and low input bias currents. These features are all available in a device which is internally compensated for excellent phase margin (70°) in a unity gain configuration.

Digital nulling techniques performed at wafer sort make it feasible to guarantee temperature stable input offset voltages as low as 25 μV . Input bias current cancellation techniques are used to obtain 10 nA input bias currents.

The OP-27 design uniquely addresses the needs of the instrumentation designer. Power supply rejection and common mode rejection are both in excess of 120 dB. A phase margin of 70° at unity gain guards against peaking (and ringing) in low gain feedback circuits. Stable operation can be obtained with capacitive loads up to 2000 pF*. Input offset voltage can be externally trimmed without affecting input offset voltage drift with temperature or time. The drift performance is, in fact, so good that the system designer must be cautioned that stray thermoelectric voltages generated by dissimilar metal at the contacts to the input terminals are enough to degrade its performance. For this reason it is also important to keep both input terminals at the same relative temperature.

The OP-27 is available in LCC, SO-8 (small-outline), TO-99 can, plastic mini-DIP and ceramic mini-DIP packages, and can be ordered with Mil-Std-883 Level B processing.

*By decoupling the load capacitance with a series resistor of 50 or more, load capacitances larger than 2000 pF can be accommodated.

Connection Information

8-Lead TO-99 Metal Can (Top View)

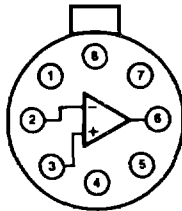

65-03205A

8-Lead Plastic Dual In-Line SO (Top View)

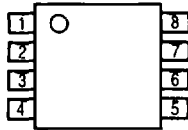

65-02696A

8-Lead Dual In-Line Package (Top View)

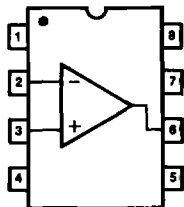

65-03206A

Pin	Function
1	V _{OS} Trim
2	-Input
3	+Input
4	-V _S
5	NC
6	Output
7	+V _S
8	V _{OS} Trim

20-Pad LCC

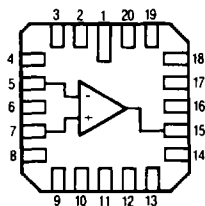

65-02657A

Pin	Function
2	V _{OS} Trim
5	-Input
7	+Input
10	-V _S
15	Output
17	+V _S
20	V _{OS} Trim

Ordering Information

Part Number	Package	Operating Temperature Range
OP-27EN	N	0°C to +70°C
OP-27FN	N	0°C to +70°C
OP-27GN	N	0°C to +70°C
OP-27EM	M	0°C to +70°C
OP-27FM	M	0°C to +70°C
OP-27GM	M	0°C to +70°C
OP-27ED	D	-25°C to +85°C
OP-27FD	D	-25°C to +85°C
OP-27GD	D	-25°C to +85°C
OP-27ET	T	-25°C to +85°C
OP-27FT	T	-25°C to +85°C
OP-27GT	T	-25°C to +85°C
OP-27AD	D	-55°C to +125°C
OP-27AD/883	D	-55°C to +125°C
OP-27BD	D	-55°C to +125°C
OP-27BD/883	D	-55°C to +125°C
OP-27CD	D	-55°C to +125°C
OP-27CD/883	D	-55°C to +125°C
OP-27AT	T	-55°C to +125°C
OP-27AT/883	T	-55°C to +125°C
OP-27BT	T	-55°C to +125°C
OP-27BT/883	T	-55°C to +125°C
OP-27CT	T	-55°C to +125°C
OP-27CT/883	T	-55°C to +125°C
OP-27AL/883	L	-55°C to +125°C
OP-27BL/883	L	-55°C to +125°C

Notes:

/883B suffix denotes Mil-Std-883, Level B processing

N = 8-lead plastic DIP

D = 8 lead ceramic DIP

T = 8-lead metal can (TO-99)

L = 20-pad leadless chip carrier

M = 8-lead plastic SOIC

Contact a Raytheon sales office or representative for ordering information on special package/temperature range combinations.

Absolute Maximum Ratings

Supply Voltage	±22V
Input Voltage*	±22V
Differential Input Voltage	0.7V
Internal Power Dissipation**	658 mW
Output Short Circuit Duration	Indefinite
Storage Temperature	
Range	-65°C to +150°C
Operating Temperature Range	
OP-27A/B/C	-55°C to +125°C
OP-27E/F/G (Hermetic)	-25°C to +85°C
OP-27E/F/G (Plastic)	0°C to +70°C
Lead Soldering Temperature	
(SO-8, 10 sec)	+260°C
(DIP, LCC, TO-99; 60 sec)	+300°C

*For supply voltages less than ±22V, the absolute maximum input voltage is equal to the supply voltage.

**Observe package thermal characteristics.

Mask Pattern

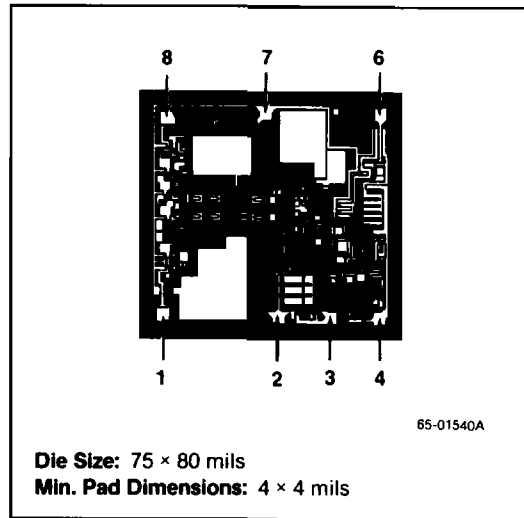

Thermal Characteristics

	8-Lead Small Outline	8-Lead Ceramic DIP	8-Lead TO-99 Metal Can	20-Pad LCC	8-Lead Plastic DIP
Max. Junction Temp.	125°C	175°C	175°C	175°C	125°C
Max. P _D T _A <50°C	300 mW	833 mW	658 mW	925 mW	468 mW
Therm. Res. θ _{JC}	—	45°C/W	50°C/W	37°C/W	—
Therm. Res. θ _{JA}	240°C/W	150°C/W	190°C/W	105°C/W	160°C/W
For T _A >50°C Derate at	4.17 mW/°C	8.33 mW/°C	5.26 mW/°C	7.0 mW/°C	6.25 mW/°C

Electrical Characteristics ($V_s = \pm 15V$ and $T_A = +25^\circ C$ unless otherwise noted)

Parameters	Test Conditions	OP-27A/E			OP-27B/F			OP-27C/G			Units
		Min	Typ	Max	Min	Typ	Max	Min	Typ	Max	
Input Offset Voltage ⁵		10	25		20	60		30	100		μV
Long Term Input Offset Voltage Stability ^{1,4}		0.2	1.0		0.3	1.5		0.4	2.0		$\mu V/Mo$
Input Offset Current		7.0	35		9.0	50		12	75		nA
Input Bias Current		± 10	± 40		± 12	± 55		± 15	± 80		nA
Input Noise Voltage ²	0.1 Hz to 10 Hz	0.08	0.18		0.08	0.18		0.09	0.25		μV_{pp}
Input Noise Voltage Density ²	$F_o = 10$ Hz	3.5	5.5		3.5	5.5		3.8	8.0		nV Hz
	$F_o = 30$ Hz	3.1	4.5		3.1	4.5		3.3	5.6		
	$F_o = 1000$ Hz	3.0	3.8		3.0	3.8		3.2	4.5		
Input Noise Current Density ²	$F_o = 10$ Hz	1.7	4.0		1.7	4.0		1.7			pA Hz
	$F_o = 30$ Hz	1.0	2.3		1.0	2.3		1.0			
	$F_o = 1000$ Hz	0.4	0.6		0.4	0.6		0.4	0.6		
Input Resistance (Diff. Mode) ⁴		1.5	6.0		1.2	5.0		0.8	4.0		M
Input Resistance (Com. Mode)		3.0			2.5			2.0			G
Input Voltage Range ³		± 11	± 12.3		± 11	± 12.3		± 11	± 12.3		V
Common Mode Rejection Ratio	$V_{CM} = \pm 11V$	114	126		106	123		100	120		dB
Power Supply Rejection Ratio	$V_s \pm 4V$ to $\pm 18V$	100	120		120	120		94	118		dB
Large Signal Voltage Gain	$R_L \geq 2k, V_o = \pm 10V$	1000	1800		1000	1800		700	1500		V/mV
	$R_L \geq 1k\Omega, V_o = \pm 10V$	800	1500		800	1500		1500			
	$V_o = \pm 1V, V_s = \pm 4V^4$	250	700		250	700		200	500		
Output Voltage Swing	$R_L \geq 2k,$	± 12	± 13.8		± 12	± 13.8		± 11.5	± 13.5		V
	$R_L \geq 600,$	± 11	± 12		± 11	± 12		± 11	± 12		
Slew Rate ⁴	$R_L \geq 2k,$	1.7	2.8		1.7	2.8		1.7	2.8		V/ μS
Gain Bandwidth Product ⁴		5.0	8.0		5.0	8.0		5.0	8.0		MHz
Open Loop Output Resistance	$V_o = 0, I_o = 0$	70			70			70			Ω
Power Consumption		90	140		90	140		100	170		mW
Offset Adjustment Range	$R_p = 10k$	± 4.0			± 4.0			± 4.0			mV

Notes:

1. Long Term Input Offset Voltage Supply refers to the average trend line of V_{os} vs. Time over extended periods after the first 30 days of operation. Excluding the initial hour of operation, changes in V_{os} during the first 30 operating days are typically 2.5 μV .
2. This parameter is tested on a sample basis only.
3. Caution: The Common Mode Input Range is a function of supply voltage. See Typical Performance Curves. Also, the input protection diodes do not allow the device to be removed or inserted into the circuit without first removing power.
4. Parameter is guaranteed but not tested.
5. Input Offset Voltage measurements are performed by automated test equipment approximately 0.5 seconds after application of power.

Electrical Characteristics ($V_s = \pm 15V$, $-55^\circ C \leq T_A \leq +125^\circ C$ unless otherwise noted)

Parameters	Test Conditions	OP-27A			OP-27B			OP-27C			Units
		Min	Typ	Max	Min	Typ	Max	Min	Typ	Max	
Input Offset Voltage ¹		30	60		50	200		70	300	μV	
Average Input Offset Voltage Drift ²		0.2	0.6		0.3	1.3		0.4	1.8	$\mu V/C$	
Input Offset Current		15	50		22	85		30	135	nA	
Input Bias Current		± 20	± 60		± 28	± 95		± 35	± 150	nA	
Input Voltage Range		± 10.3	± 11.5		± 10.3	± 11.5		± 10.2	± 11.5	V	
Common Mode Rejection Ratio	$V_{CM} = \pm 10V$	108	122		100	119		94	116	dB	
Power Supply Rejection Ratio	$V_s \pm 4.5V$ to $\pm 18V$	96	116		94	114		86	110	dB	
Large Signal Voltage Gain	$R_L \geq 2 k$, $V_o = \pm 10V$	600	1200		500	1000		300	800	V/mV	
Output Voltage Swing	$R_L \geq 2 k$	± 11.5	± 13.5		± 11	± 13.2		± 10.5	± 13	V	

Electrical Characteristics ($V_s = \pm 15V$, $-25^\circ C \leq T_A \leq +85^\circ C$ for hermetic package types, $0^\circ C \leq T_A \leq +70^\circ C$ for plastic packages unless otherwise noted)

Parameters	Test Conditions	OP-27E			OP-27F			OP-27G			Units
		Min	Typ	Max	Min	Typ	Max	Min	Typ	Max	
Input Offset Voltage ¹		20	50		40	140		55	220	μV	
Average Input Offset Voltage Drift ²		0.2	0.6		0.3	1.3		0.4	1.8	$\mu V/C$	
Input Offset Current		10	50		14	85		20	135	nA	
Input Bias Current		± 10	± 40		± 12	± 55		± 25	± 150	nA	
Input Voltage Range		± 10.5	± 11.8		± 10.5	± 11.8		± 10.5	± 11.8	V	
Common Mode Rejection Ratio	$V_{CM} = \pm 10V$	110	124		102	121		96	118	dB	
Power Supply Rejection Ratio	$V_s \pm 4.5V$ to $\pm 18V$	97	118		96	116		90	114	dB	
Large Signal Voltage Gain	$R_L \geq 2 k$, $V_o = \pm 10V$	750	1500		700	1300		450	1000	V/mV	
Output Voltage Swing	$R_L \geq 2 k$	± 11.7	± 13.6		± 11.4	± 13.5		± 11	± 13.3	V	

Notes:

- Input Offset Voltage measurements are performed by automated test equipment approximately 0.5 seconds after application of power.
- $T_C V_{OS}$ performance is guaranteed unnullled or when nullled with $R_p = 8.0 k$ to $20 k$.

Typical Performance Characteristics

0.1Hz to 10Hz Noise Test Circuit

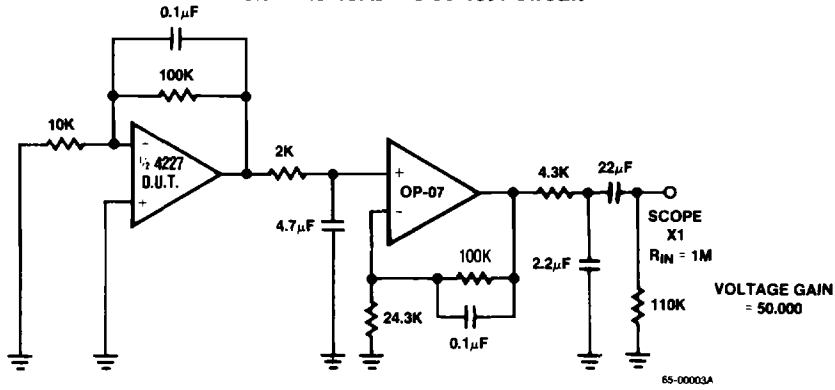

0.1Hz to 10Hz Peak-to-Peak Noise Tester Frequency Response

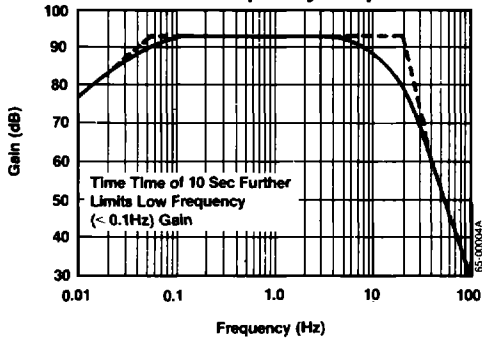

Open Loop Gain vs. Frequency

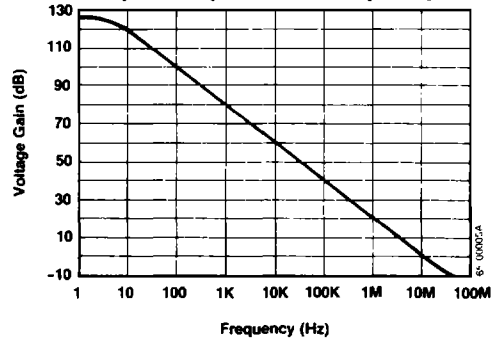

Gain, Phase Shift vs. Frequency

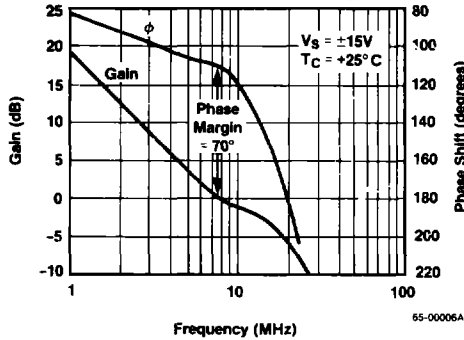

Slew Rate, Gain Bandwidth Product, Phase Margin vs. Temperature

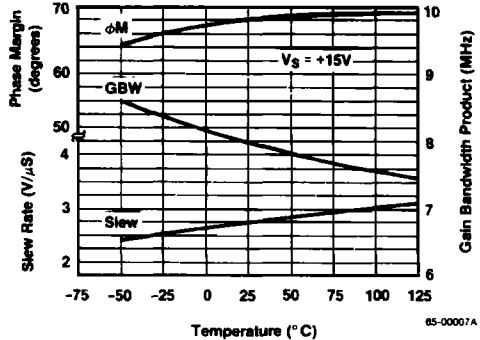

Typical Performance Characteristics (Continued)

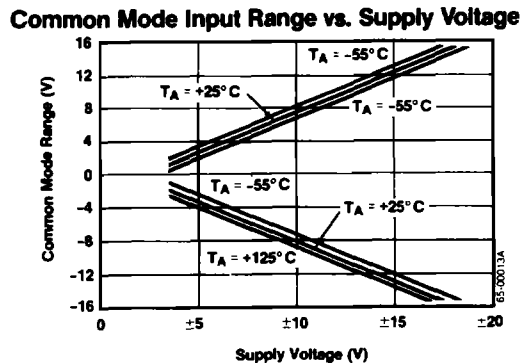
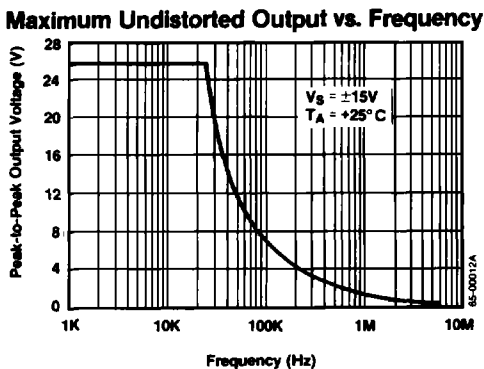
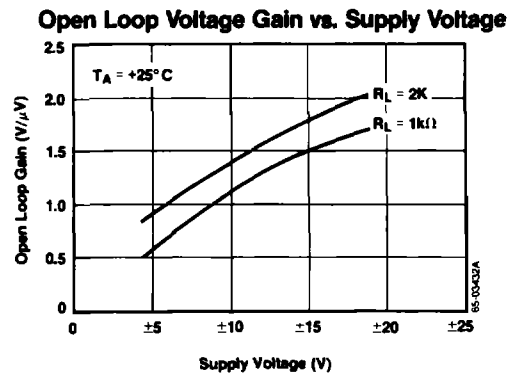
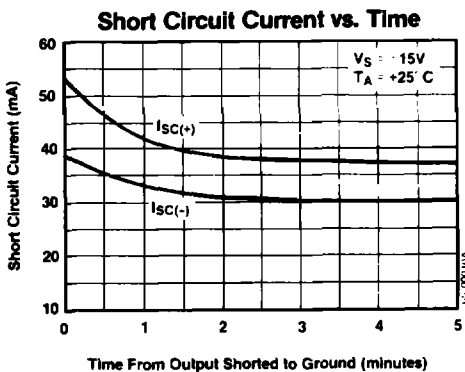
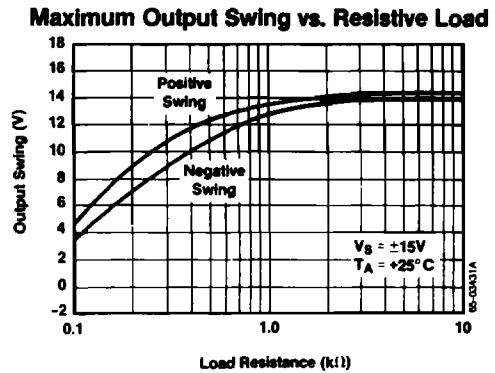
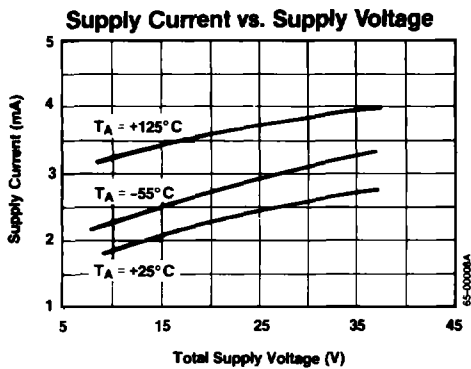

Typical Performance Characteristics (Continued)

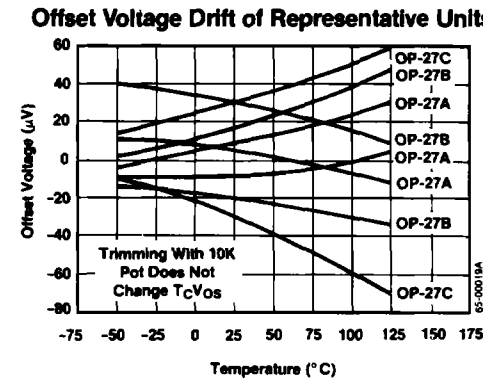
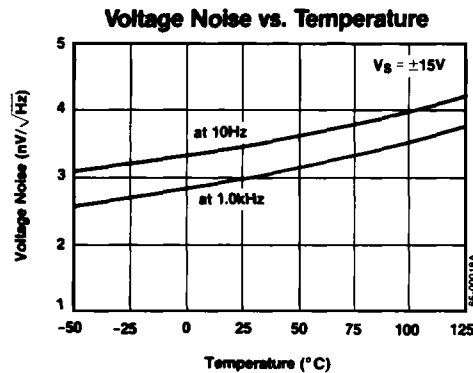
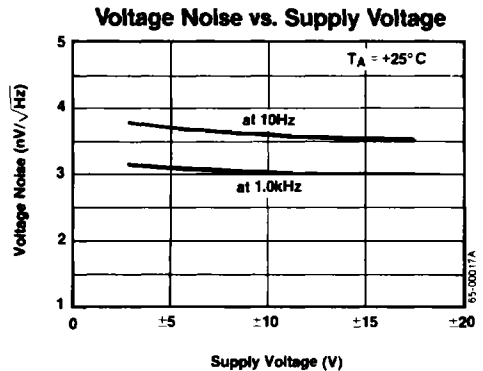
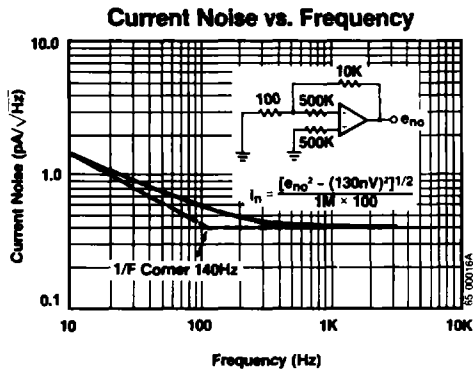
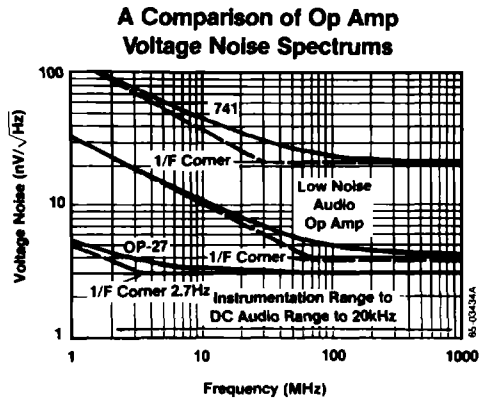
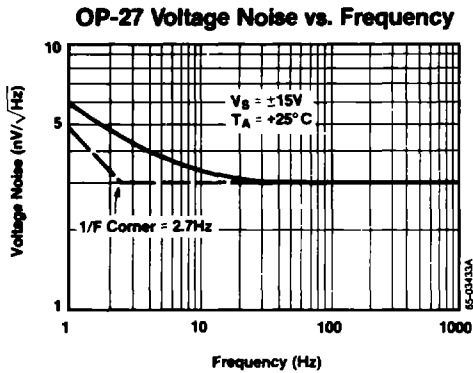

Typical Performance Characteristics (Continued)

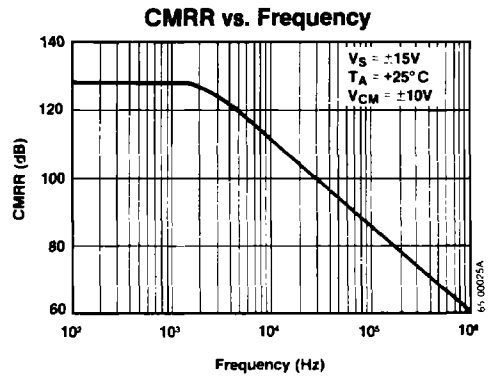
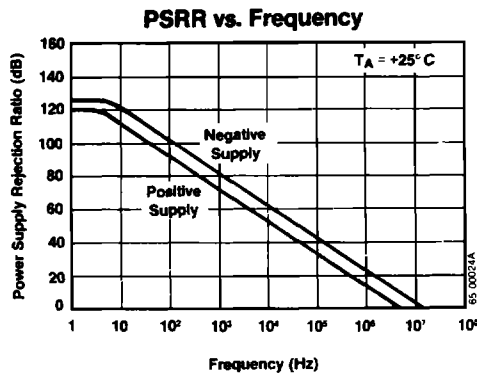
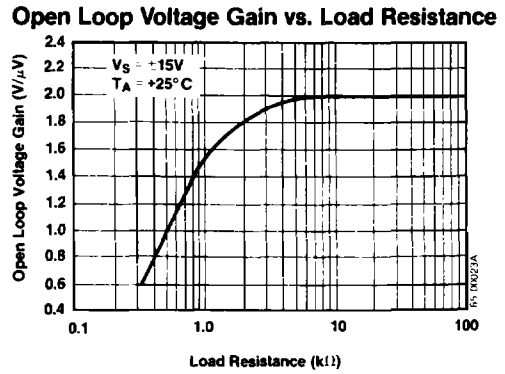
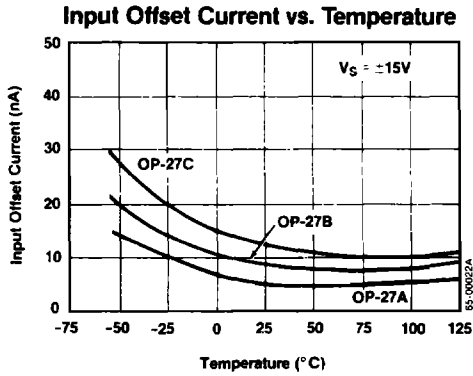
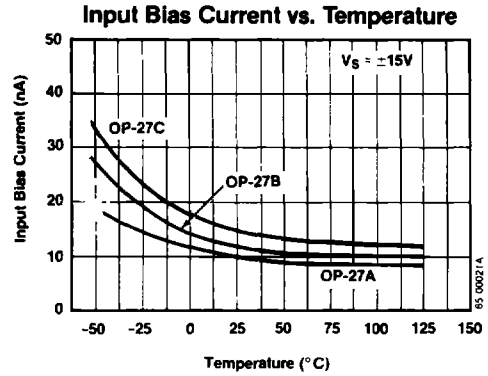
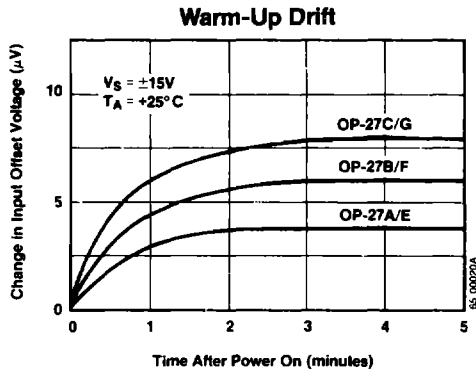

Typical Performance Characteristics (Continued)

Small Signal Overshoot vs. Capacitive Load

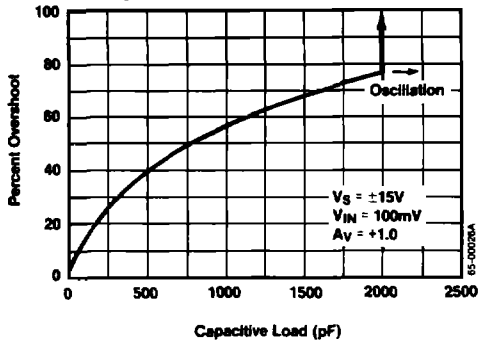

OP-27 0.1Hz to 10Hz Peak-to-Peak Noise
Vertical Scale 50nV/Division
Recorder Speed 16 Divisions/Min

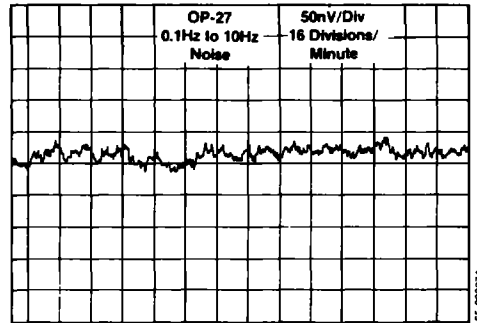

Offset Nulling Circuit

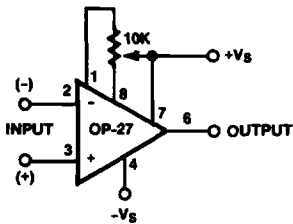

85-00028A

Burn-In Circuit

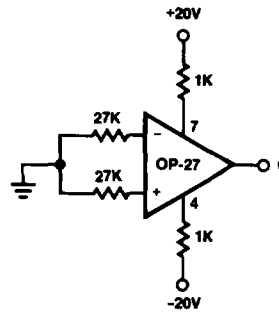

85-00028A

Large Signal Transient Response

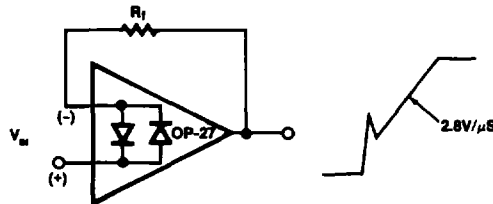

When $R_f \leq 100\Omega$ and the input is driven with a fast, large signal pulse ($\geq 1.0V$), the output waveform will look as shown.

85-00030A

Typical Applications

RIAA Phono Preamplifier (Figure 1)

The new moving coil magnetic phono cartridges have sensitivities that are an order of magnitude lower than the sensitivity of a typical moving magnet cartridge (0.1 mV per CM/S versus 1.0 mV per CM/S). This places a greater burden on the preamplifier to achieve more gain and less noise. The OP-27 is ideally suited for this task. The object in designing an RIAA phono preamp is to achieve the RIAA gain-frequency response curve while contributing as little noise as possible to avoid masking the very small signal generated by the cartridge. The circuit shown is adjusted to match a 40 dB RIAA curve as shown in Figure 2. Note that by convention the RIAA gain is specified at 1 kHz. With the "break points" of the curves specified at 50,500 and 2.1 kHz respectively the entire curve is fixed by the specified gain at 1 kHz.

The circuit is designed to operate with a 3/4000Ω step-up transformer to present the optimum source impedance to the amplifier for best noise figure. The optimum source impedance is obtained as the ratio of the spectral noise

voltage e_n to the spectral noise current i_n (when e_n has dimensions of nV/√Hz and i_n has dimensions of pA/√Hz and the ratio has dimensions of kΩ). The circuit is designed to be tested and adjusted independent of the transformer, for this purpose introduce a very low level signal 1 mV at test point TP-1. The first stage is a wideband stage which provides a small amount of gain $(1 + R4/R5)$ approximately equal to 10 dB. Low value feedback resistors must be used to prevent additional noise due to the spectral current noise or excessive Johnson noise. The gain of the first stage reduces the noise contribution of the second stage. The RIAA transfer curve poles and zeros are due entirely to the feedback network of the second stage.

The poles and zeros of the RIAA feedback network are sufficiently separated in frequency that they may be estimated with the following equations:

$$f_1(50\text{Hz}) \approx \frac{1}{2\pi R7C3}$$

$$f_2(500\text{Hz}) \approx \frac{1}{2\pi R8C3}$$

$$f_3(2100\text{Hz}) \approx \frac{1}{2\pi R8C2}$$

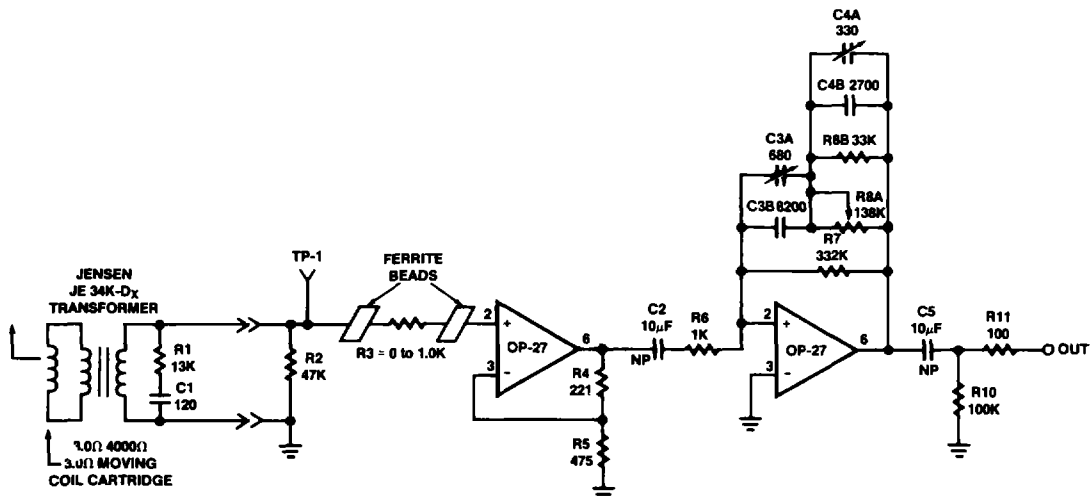

To test, disconnect transformer and inject signal at TP-1.

65-000318

Figure 1. RIAA Phono Preamplifier

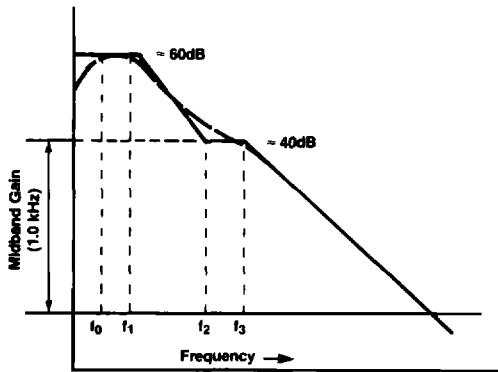

- f_0 = Low end rolloff frequency (user selected)
 f_1 = 50 Hz
 f_2 = 500 Hz
 f_3 = 2.1 kHz

65-00032A

Figure 2. RIAA Phone Playback Equalization Curve

These equations are only approximations. Final tuning is performed with the adjustable capacitors and potentiometers. The following sequence can be used to adjust for the RIAA response after injecting a low level signal into TP-1 (transformer disconnected).

1. At 100 Hz adjust C3A for an output level 6 dB lower than the low frequency output.
2. At 1000 Hz adjust R8A for an output level 20 dB lower than the low frequency output.
3. At 21 kHz adjust C4A for an output 40 dB less than the low frequency output.

Low Impedance Microphone Preamp (Figure 3)

In this preamp the transformer converts the low microphone impedance up to a value that is close to the optimum source impedance required by the OP-27 for best noise performance. The optimum source impedance can be calculated as the ratio of e_n/i_n which for the OP-27 is approximately 7000 Ω . Fortunately

the noise performance does not degrade appreciably until the source impedance is four or five times this optimum value and the source impedance at the output of this transformer, approximately 15 k Ω , still provides near optimum noise performance. (A high quality audio transformer with a step-up ratio of 6.7 to one is not available.) The voltage gain of the amplifier, not including the transformer step-up, is unity up to about 1.5 Hz. It may be desirable to reduce the size of this capacitor to minimize burst noise even though the OP-27 has a 1/f noise corner below 3 Hz. C2 rolls off the high frequency response at 90 kHz giving a noise power bandwidth of 140 kHz.

Instrumentation

The OP-27 is particularly adaptable to instrumentation applications. When wired into a single op amp difference amplifier configuration, the OP-27 exhibits outstanding common mode rejection ratio. The spot voltage noise is so low that it is dominated almost entirely by the resistor Johnson noise.

The three op amp instrumentation amplifier of Figure 8 avoids the low input impedance characteristics of difference amplifiers at the expense of two more operational amplifiers and a slight degradation in noise performance. The noise increases because two amplifiers are contributing to the input voltage spectral noise instead of one. Thus the noise contribution, exclusive of resistor Johnson noise, increases by slightly more than the $\sqrt{2}$. The spectral noise voltage increases from approximately 3 nV/ $\sqrt{\text{Hz}}$ to approximately 4.9 nV/ $\sqrt{\text{Hz}}$, with the third amplifier contributing about 10% of the noise. The gain of the input amplifier is set at 25 and the second stage at 40 for an overall gain of 1000. R7 is trimmed to optimize the common mode rejection ratio (CMRR) with frequency. With balanced source resistors a CMRR of 100 dB is achieved. With a 1 k Ω source impedance imbalance CMRR is degraded to 80 dB at 5 kHz due to the finite (3 G Ω) input impedance.

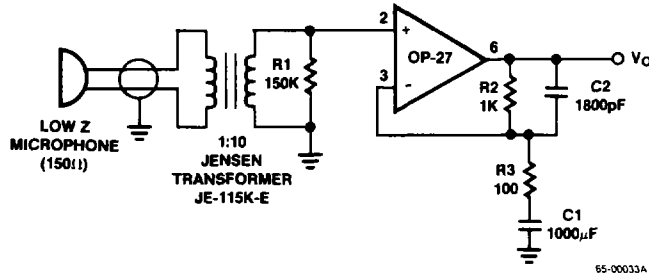

Figure 3. Low Impedance Microphone Preamplifier

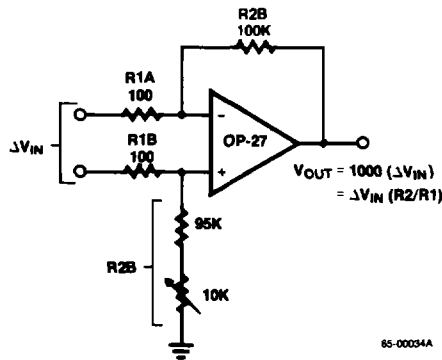
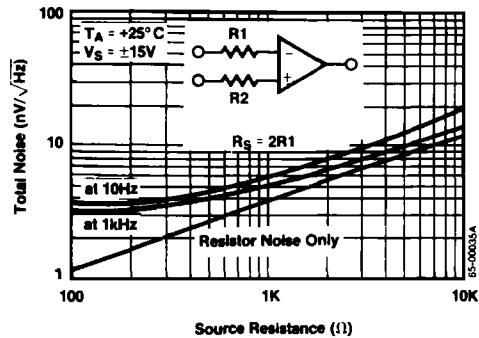

Figure 4. A Single Op Amp IC Difference Amplifier Using an OP-27. The Difference Amplifier is Connected for a Gain of 1000.



Voltage noise vs. source resistance for the difference amplifier. Noise performance shown is for $V_S = \pm 15V$, $T_A = +25^\circ C$, and $R_S = R_1 + R_2$.

Figure 5. Total Noise vs. Source Resistance

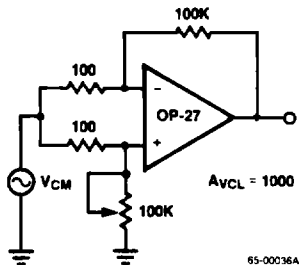

Figure 6. Common Mode Rejection Ratio Test Circuit

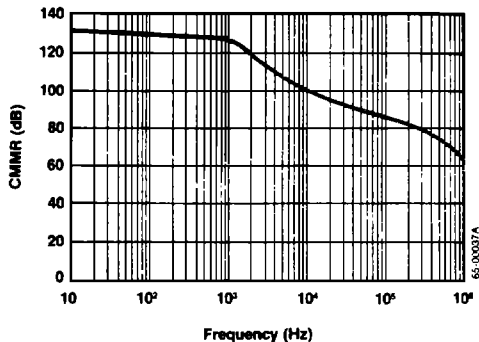
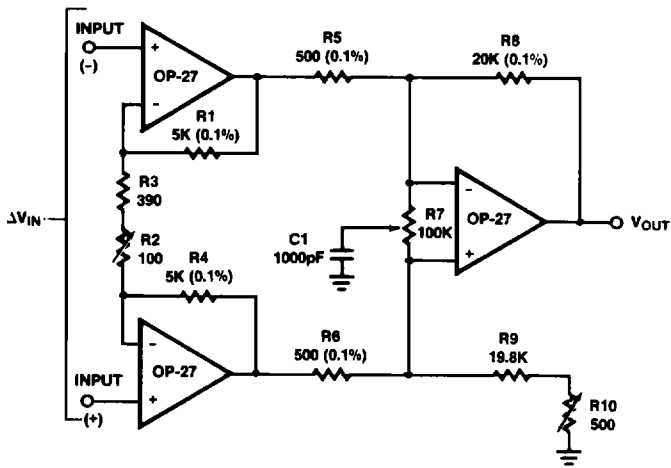

Figure 7. Common Mode Rejection Ratio vs. Frequency for the Circuit of Figure 4



Trim R2 for $A_{VCL} = 1000$
 Trim R10 for DC CMRR
 Trim R7 for Minimum V_{OUT} at $V_{CM} = 20V_{p-p}$ 10kHz

Figure 8. Three Op Amp IC Instrumentation Amplifier

Schematic Diagram

