

Tantalum Chip Capacitors

Type TMC: Standard Capacitance Range

1. Scope of Application

The TMC Series of molded tantalum chip capacitors offers an extensive range of values in EIA - US and EIA - Japan compatible sizes. By design, strict process control and a commitment to provide the most reliable product in the industry, the TMC has passed our customers' most severe humidity / temperature / pressure induced life stress testing. For surface mount applications, the space saving, highly reliable TMC is the preferred tantalum chip capacitor.

2. Features

- Epoxy Molded Body, UL94V-0 Flammability
- Extended Values Per Case Size
- EIA - US and EIA - Japan Compatible Sizes
- Excellent Humidity and Solder Resistance
- 100% Burn-in and End-of-Line Testing

3. Type Designation

The type designation shall be the following form:

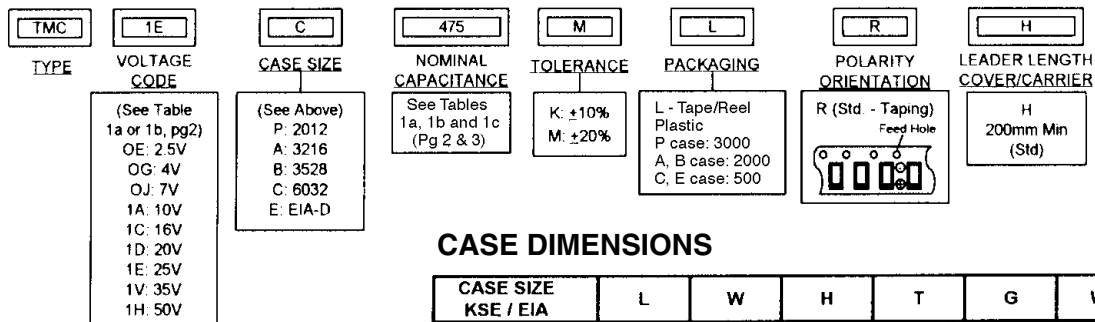

CASE DIMENSIONS

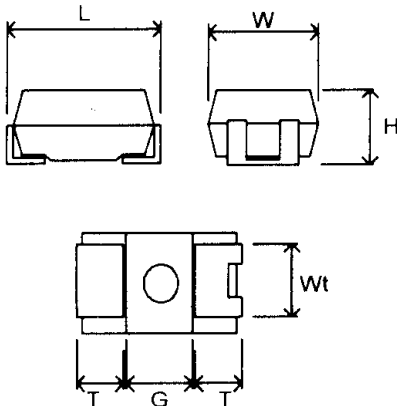

CASE SIZE KSE / EIA		L	W	H	T	G	Wt
P/2012	mm	2.0 ± 0.2	1.25 ± 0.2	1.2 MAX	0.5 ± 0.3	0.8 MIN	0.9 ± 0.1
	in	0.078 +0.008	0.049 +0.008	0.05 MAX	0.020 +0.012	0.03 MIN	0.035 +0.004
A/3216	mm	3.2 ± 0.2	1.6 ± 0.2	1.6 ± 0.2	0.7 ± 0.3	1.4 ± 0.2	1.2 ± 0.2
	in	0.126 +0.008	0.063 +0.008	0.063 +0.008	0.028 +0.012	0.055 +0.008	0.047 +0.008
B/3528	mm	3.5 ± 0.2	2.8 ± 0.2	1.9 ± 0.2	0.8 ± 0.3	1.4 ± 0.2	2.2 ± 0.2
	in	0.138 +0.008	0.110 +0.008	0.073 +0.008	0.031 +0.012	0.055 +0.008	0.087 +0.008
C/6032	mm	6.0 ± 0.3	3.2 ± 0.2	2.5 ± 0.2	1.3 ± 0.3	2.4 ± 0.2	2.2 ± 0.2
	in	0.236 +0.012	0.126 +0.008	0.098 +0.008	0.051 +0.012	0.094 +0.008	0.087 +0.008
E/7343 (EIA-D)	mm	7.3 ± 0.3	4.3 ± 0.3	2.8 ± 0.2	1.3 ± 0.3	3.8 ± 0.2	2.4 ± 0.1
	in	0.287 +0.012	0.169 +0.012	0.110 +0.008	0.051 +0.012	0.15 +0.008	0.094 +0.004

STANDARD RANGE

CASE SIZE (Table 1a)

STANDARD VALUES VOLTAGE CODE		0G	0J	1A	1C	1D	1E	1V	1H
85°C	RATED VOLTAGE (VDC)	4	7	10	16	20	25	35	50
	SURGE VOLTAGE (VDC)	5	9	13	20	26	32	46	63
125°C	DERATED VOLTAGE (VDC)	2.5	4	6.3	10	13	16	23	32
CAPACITANCE (μF)	CAP CODE								
0.1	104							A	A
0.15	154							A	B
0.22	224							A	B
0.33	334							A	B
0.47	474						A	B	C
0.68	684					A		B	C
1.0	105				A			B	C
1.5	155			A			B	C	E
2.2	225		A			B		C	E
3.3	335	A			B			C	
4.7	475			B			C	E	
6.8	685		B			C		E	
10	106	B			C		E		
15	156			C		E			
22	226		C		E				
33	336	C		E					
47	476		E						
68	686	E							

PART MARKING

A & B Case

Abbreviated Capacitance
A6: 1.0 μF

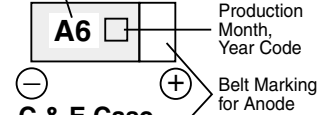

C & E Case

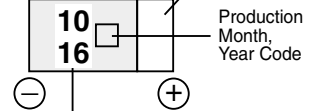

Upper number indicates capacitance in μF.
Lower number indicates rated voltage (16V).

Marking	Value (μF)
A5	0.10
E5	0.15
J5	0.22
N5	0.33
S5	0.47
W5	0.68
A6	1.0
E6	1.5
J6	2.2
N6	3.3
S6	4.7
W6	6.8
A7	10.0

CASE SIZE (Table 1b) TMCP series

STANDARD VALUES VOLTAGE CODE		OE	0G	0J	1A	1C	1D	1E
RATED VOLTAGE (VDC)		2.5	4	6.3	10	16	20	25
CAPACITANCE (μF)	CAP CODE							
0.10	104						P	
0.15	154						P	
0.22	224						P	
0.33	334						P	
0.47	474					P	P	
0.68	684				P	P	P	
1.0	105			P	P	P		
1.5	155		P	P	P			
2.2	225	P	P	P	P			
3.3	335	P	P	P	P			
4.7	475	P	P	P	P			
6.8	685	P	P	P				
10.0	106	P	P	P				
15.0	156	P	P					
22.0	226	P	P					

PART MARKING

6.3V1 μF

Abbreviated Capacitance
(A6: 1 μF)

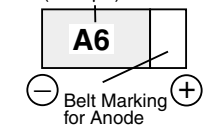

10V1 μF

Abbreviated Capacitance
(A: 1 μF)

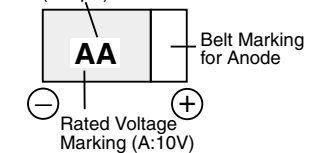

In case that simple capacitance symbol is same as case size, rated voltage symbol is marking on higher voltage one.

When marking the symbol of rated voltage and capacitance, a multiplier of capacitance symbol is omitted.

Simple symbol is referenced to JIS C 5143 clause 10, and EIAJ RC-3813 clause 7.1.

EXTENDED RANGE

CASE SIZE (Table 1c) Includes Standard and P case sizes

PART MARKING

A, B & P Case

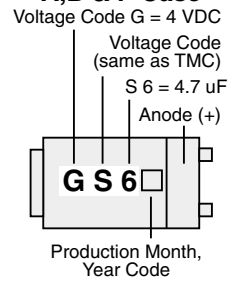

C & E Case

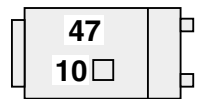

Marking	Voltage
e	2.5
G	4
J	7
A	10
C	16
D	20
E	25
V	35
H	50

NOTE: To obtain ENVIRONMENTAL SPECIFICATIONS INFORMATION please contact KOA Speer.

STANDARD VALUES VOLTAGE CODE		0E	0G	0J	1A	1C	1D	1E	1V	1H
85°C	RATED VOLTAGE (VDC)	2.5	4	7	10	16	20	25	35	50
	SURGE VOLTAGE (VDC)	3.2	5	9	13	20	26	32	46	63
125°C	DERATED VOLTAGE (VDC)	1.6	2.5	4	6.3	10	13	16	23	32
CAPACITANCE (μ F)		CAP CODE								
0.10	104						P		A	A
0.15	154						P		A	AB
0.22	224						P		A	AB
0.33	334						P		A	B
0.47	474					P	P	A	AB	BC
0.68	684				P	P	AP	A	AB	BC
1.0	105			P	P	AP	A	A	AB	C
1.5	155		P	P	AP	A	A	AB	BC	CE
2.2	225	P	P	AP	AP	A	AB	B	BC	CE
3.3	335	P	AP	AP	AP	AB	AB	B	BC	E
4.7	475	P	AP	AP	ABP	AB	ABC	BC	CE	E
6.8	685	AP	AP	ABP	AB	AB	BC	C	CE	
10.0	106	AP	ABP	ABP	AB	ABC	BC	CE	CE	
15.0	156	AP	ABP	AB	ABC	BC	CE	CE	E	
22.0	226	ABP	ABP	ABC	BC	BCE	CE	E	E	
33.0	336	AB	ABC	ABC	BCE	CE	E	E		
47.0	476	AB	ABC	BCE	BCE	CE	E			
68.0	686	BC	BCE	BCE	CE	E				
100	107	BC	BCE	BCE	CE	E				
150	157	CE	CE	BCE	E					
220	227	CE	CE	E	E					
330	337	E	E	E						
470	477	E	E							

TECHNICAL DATA

Part No.	EIA Case	μ F	Leakage μ A (MAX)	TanD % max	ESR Max (Ω) 100 kHz
2.5 VDC @ 85°C					
TMCOEP225	P	2.2	0.50	8	25.0
TMCOEP335	P	3.3	0.50	8	25.0
TMCOEP475	P	4.7	0.50	8	12.0
TMCOEP685	P	6.8	0.50	8	10.0
TMCOEA685	A	6.8	0.50	6	6.5
TMCOEP106	P	10	0.50	8	9.0
TMCOEA106	A	10	0.50	8	6.0
TMCOEP156	P	15	0.50	8	8.0
TMCOEA156	A	15	0.50	8	4.0
TMCOEP226	P	22	0.55	8	7.0
TMCOEA226	A	22	0.55	8	2.8
TMCOEB226	B	22	0.55	8	2.5
TMCOEA336	A	33	0.83	8	4.0
TMCOEB336	B	33	0.83	8	2.8
TMCOGA476	A	47	1.18	12	3.0
TMCOEB476	B	47	1.18	8	2.4
TMCOEB686	B	68	1.70	8	1.8
TMCOEC686	C	68	1.70	8	1.6
TMCOEB107	B	100	2.50	12	0.9
TMCOEC107	C	100	2.50	8	0.9
TMCOEC157	C	150	3.75	8	0.9

Part No.	EIA Case	μ F	Leakage μ A (MAX)	TanD % max	ESR Max (Ω) 100 kHz
2.5 VDC @ 85°C continued					
TMCOEE157	D	150	3.75	8	0.9
TMCOEC227	C	220	5.50	8	0.9
TMCOEE227	D	220	5.50	8	0.9
TMCOEE337	D	330	8.25	10	0.9
TMCOEE477	D	470	11.75	10	0.5
4.0 VDC @ 85°C					
TMCOGP155	P	1.5	0.50	8	25.0
TMCOGP225	P	2.2	0.50	8	25.0
TMCOGP335	P	3.3	0.50	8	20.0
TMCOGA335	A	3.3	0.50	6	9.0
TMCOGP475	P	4.7	0.50	8	12.0
TMCOGA475	A	4.7	0.50	6	7.5
TMCOGP685	P	6.8	0.50	8	10.0
TMCOGA685	A	6.8	0.50	6	6.5
TMCOGP106	P	10	0.50	8	9.0
TMCOGA106	A	10	0.50	6	3.0
TMCOGB106	B	10	0.50	6	4.0
TMCOGP156	P	15	0.60	8	8.0
TMCOGA156	A	15	0.60	8	4.0
TMCOGB156	B	15	0.60	8	3.0

TECHNICAL DATA (continued)

Part No.	EIA Case	μF	Leakage μA (MAX)	TanD % max	ESR Max (Ω) 100 kHz
4.0 VDC @ 85°C continued					
TMCOGP226	P	22	0.88	8	6.0
TMCOGA226	A	22	0.88	8	2.8
TMCOGB226	B	22	0.88	8	2.5
TMCOGA336	A	33	1.32	8	4.0
TMCOGB336	B	33	1.32	8	2.8
TMCOGC336	C	33	1.32	6	2.0
TMCOGA476	A	47	1.88	12	4.0
TMCOGB476	B	47	1.88	8	2.4
TMCOGC476	C	47	1.88	8	1.8
TMCOGB686	B	68	2.72	8	1.8
TMCOGC686	C	68	2.72	8	1.6
TMCOGE686	D	68	2.72	6	1.1
TMCOGB107	B	100	4.00	12	4.0
TMCOGC107	C	100	4.00	8	0.9
TMCOGE107	D	100	4.00	8	0.9
TMCOGC157	C	150	6.00	8	0.9
TMCOGE157	D	150	6.00	8	0.9
TMCOGC227	C	220	8.80	12	4.0
TMCOGE227	D	220	8.80	8	0.9
TMCOGE337	D	330	13.20	10	0.9
TMCOGE477	D	470	18.80	10	0.5
7.0 VDC @ 85°C					
TMCOJP105	P	1.0	0.50	6	25.0
TMCOJP155	P	1.5	0.50	6	25.0
TMCOJP225	P	2.2	0.50	8	25.0
TMCOJA225	A	2.2	0.50	6	8.0
TMCOJP335	P	3.3	0.50	8	12.0
TMCOJA335	A	3.3	0.50	6	7.0
TMCOJP475	P	4.7	0.50	8	10.0
TMCOJA475	A	4.7	0.50	6	6.0
TMCOJP685	P	6.8	0.50	8	9.0
TMCOJA685	A	6.8	0.50	6	5.0
TMCOJB685	B	6.8	0.50	6	4.0
TMCOJP106	P	10	0.50	8	8.0
TMCOJA106	A	10	0.70	8	4.0
TMCOJB106	B	10	0.70	8	3.0
TMCOJA156	A	15	1.05	8	2.8
TMCOJB156	B	15	1.05	8	2.5
TMCOJA226	A	22	1.54	8	4.0
TMCOJB226	B	22	1.54	8	2.3
TMCOJC226	C	22	1.54	6	2.0
TMCOJA336	A	33	2.31	10	4.0
TMCOJB336	B	33	2.31	8	2.0
TMCOJC336	C	33	2.31	8	1.8
TMCOJB476	B	47	3.29	8	1.8
TMCOJC476	C	47	3.29	8	1.6
TMCOJE476	D	47	3.29	6	1.1
TMCOJB686	B	68	4.28	10	4.0
TMCOJC686	C	68	4.76	8	1.5
TMCOJE686	D	68	4.76	8	0.9
TMCOJB107	B	100	6.30	8	4.0
TMCOJC107	C	100	7.00	8	0.9
TMCOJE107	D	100	7.00	8	0.9
TMCOJB157	B	150	6.00	8	4.0
TMCOJC157	C	150	9.45	10	4.0
TMCOJE157	D	150	10.50	8	0.9
TMCOJE227	D	220	15.40	8	0.9

Part No.	EIA Case	μF	Leakage μA (MAX)	TanD % max	ESR Max (Ω) 100 kHz
7.0 VDC @ 85°C continued					
TMCOJE337	D	330	23.10	10	0.5
10 VDC @ 85°C					
TMC1AP684	P	0.68	0.50	6	25.0
TMC1AP105	P	1.0	0.50	6	25.0
TMC1AP155	P	1.5	0.50	8	20.0
TMC1AA155	A	1.5	0.50	6	10.0
TMC1AP225	P	2.2	0.50	8	15.0
TMC1AA225	A	2.2	0.50	6	7.0
TMC1AP335	P	3.3	0.50	8	10.0
TMC1AA335	A	3.3	0.50	6	5.5
TMC1AP475	P	4.7	0.50	8	9.0
TMC1AA475	A	4.7	0.50	6	5.0
TMC1AB475	B	4.7	0.50	6	4.0
TMC1AA685	A	6.8	0.68	6	3.6
TMC1AB685	B	6.8	0.68	6	3.0
TMC1AA106	A	10	1.00	8	2.8
TMC1AB106	B	10	1.00	8	2.5
TMC1AA156	A	15	1.50	8	3.2
TMC1AB156	B	15	1.50	8	2.8
TMC1AC156	C	15	1.50	6	2.0
TMC1AB226	B	22	2.20	8	2.0
TMC1AC226	C	22	2.20	8	1.8
TMC1AB336	B	33	3.30	8	1.8
TMC1AC336	C	33	3.30	8	1.6
TMC1AE336	D	33	3.30	6	1.1
TMC1AB476	B	47	4.70	10	4.0
TMC1AC476	C	47	4.70	8	1.1
TMC1AE476	D	47	4.70	8	0.9
TMC1AC686	C	68	6.80	8	0.9
TMC1AE686	D	68	6.80	8	0.9
TMC1AC107	C	100	10.00	10	4.0
TMC1AE107	D	100	10.00	8	0.9
TMC1AE157	D	150	15.00	8	0.9
TMC1AE227	D	220	22.00	8	0.6
16 VDC @ 85°C					
TMC1CP474	P	0.47	0.50	6	25.0
TMC1CP684	P	0.68	0.50	6	25.0
TMC1CP105	P	1.0	0.50	6	20.0
TMC1CA105	A	1.0	0.50	4	11.0
TMC1CA155	A	1.5	0.50	6	8.0
TMC1CA225	A	2.2	0.50	6	6.5
TMC1CA335	A	3.3	0.53	6	5.0
TMC1CB335	B	3.3	0.53	6	4.5
TMC1CA475	A	4.7	0.75	6	4.0
TMC1CB475	B	4.7	0.75	6	3.5
TMC1CA685	A	6.8	1.09	6	3.0
TMC1CB685	B	6.8	1.09	6	2.5
TMC1CA106	A	10	1.60	8	4.0
TMC1CB106	B	10	1.60	8	2.8
TMC1CC106	C	10	1.60	6	2.0
TMC1CB156	B	15	2.40	8	2.0
TMC1CC156	C	15	2.40	8	1.8
TMC1CC226	C	22	3.52	8	1.6
TMC1CE226	D	22	3.52	6	1.1
TMC1CC336	C	33	5.28	8	1.1
TMC1CE336	D	33	5.28	8	0.9

TECHNICAL DATA (continued)

Part No.	EIA Case	μF	Leakage μA (MAX)	TanD % max	ESR Max (Ω) 100 kHz
16 VDC @ 85°C continued					
TMC1CC476	C	47	7.52	8	1.2
TMC1CE476	D	47	7.52	8	0.9
TMC1CE686	D	68	10.90	8	0.9
TMC1CE107	D	100	16.00	8	0.9
20 VDC @ 85°C					
TMC1DP104	P	0.10	0.50	6	25.0
TMC1DP154	P	0.15	0.50	6	25.0
TMC1DP224	P	0.22	0.50	6	25.0
TMC1DP334	P	0.33	0.50	6	25.0
TMC1DP474	P	0.47	0.50	6	25.0
TMC1DP684	P	0.68	0.50	6	25.0
TMC1DA684	A	0.68	0.50	4	12.0
TMC1DA105	A	1.0	0.50	4	8.0
TMC1DA155	A	1.5	0.50	6	6.5
TMC1DA225	A	2.2	0.50	6	5.0
TMC1DB225	B	2.2	0.50	6	3.5
TMC1DA335	A	3.3	0.66	6	3.5
TMC1DB335	B	3.3	0.66	6	3.0
TMC1DA475	A	4.7	0.94	6	3.0
TMC1DB475	B	4.7	0.94	6	3.0
TMC1DB685	B	6.8	1.36	6	2.5
TMC1DC685	C	6.8	1.36	6	2.0
TMC1DB106	B	10	2.00	8	2.0
TMC1DC106	C	10	2.00	8	1.9
TMC1DC156	C	15	3.00	8	1.7
TMC1DE156	D	15	3.00	6	1.1
TMC1DC226	C	22	4.40	8	1.1
TMC1DE226	D	22	4.40	8	0.9
TMC1DD336	J	33	6.60	8	0.9
TMC1DE336	D	33	6.60	8	0.9
TMC1DE476	D	47	9.40	8	0.9
25 VDC @ 85°C					
TMC1EA474	A	0.47	0.50	4	14.0
TMC1EA684	A	0.68	0.50	4	10.0
TMC1EA105	A	1.0	0.50	4	8.0
TMC1EA155	A	1.5	0.50	6	7.5
TMC1EB155	B	1.5	0.50	6	5.0
TMC1EB225	B	2.2	0.55	6	4.5
TMC1EB335	B	3.3	0.83	6	3.5
TMC1EB475	B	4.7	1.18	6	3.0
TMC1EC475	C	4.7	1.18	6	2.4
TMC1EC685	C	6.8	1.70	6	2.0
TMC1EC106	C	10	2.50	8	1.8
TMC1EE106	D	10	2.50	6	1.2
TMC1EE156	D	15	3.75	8	1.0
TMC1EE226	D	22	5.50	8	0.9
TMC1EE336	D	33	8.25	8	0.9
35 VDC @ 85°C					
TMC1VA104	A	0.1	0.50	4	24.0
TMC1VA154	A	0.15	0.50	4	21.0
TMC1VA224	A	0.22	0.50	4	18.0
TMC1VA334	A	0.33	0.50	4	15.0
TMC1VA474	A	0.47	0.50	4	12.0

Part No.	EIA Case	μF	Leakage μA (MAX)	TanD % max	ESR Max (Ω) 100 kHz
35 VDC @ 85°C continued					
TMC1VB474	B	0.47	0.50	4	10.0
TMC1VA684	A	0.68	0.50	4	8.0
TMC1VB684	B	0.68	0.50	4	8.0
TMC1VA105	A	1.0	0.50	4	7.0
TMC1VB105	B	1.0	0.50	4	6.5
TMC1VB155	B	1.5	0.53	6	5.2
TMC1VC155	C	1.5	0.53	6	4.5
TMC1VB225	B	2.2	0.77	6	4.2
TMC1VC225	C	2.2	0.77	6	3.5
TMC1VB335	B	3.3	1.16	6	3.0
TMC1VC335	C	3.3	1.16	6	2.5
TMC1VC475	C	4.7	1.65	6	2.2
TMC1VE475	D	4.7	1.65	6	1.5
TMC1VC685	C	6.8	2.38	6	1.5
TMC1VE685	D	6.8	2.38	6	1.3
TMC1VC106	C	10	3.5	8	1.6
TMC1VE106	D	10	3.50	8	1.0
TMC1VE156	D	15	5.25	8	1.0
TMC1VE226	D	22	7.70	6	0.9
50 VDC @ 85°C					
TMC1HA104	A	0.1	0.50	4	22.0
TMC1HA154	A	0.15	0.50	4	16.0
TMC1HB154	B	0.15	0.50	4	17.0
TMC1HA224	A	0.22	0.50	4	18.0
TMC1HB224	B	0.22	0.50	4	14.0
TMC1HB334	B	0.33	0.50	4	12.0
TMC1HB474	B	0.47	0.50	4	10.0
TMC1HC474	C	0.47	0.50	4	8.0
TMC1HB684	B	0.68	0.50	4	7.0
TMC1HC684	C	0.68	0.50	4	7.0
TMC1HC105	C	1.0	0.50	4	5.5
TMC1HC155	C	1.5	0.75	6	4.0
TMC1HE155	D	1.5	0.75	6	4.0
TMC1HC225	C	2.2	1.10	6	2.5
TMC1HE225	D	2.2	1.10	6	2.5
TMC1HE335	D	3.3	1.65	6	2.0
TMC1HE475	D	4.7	3.35	6	1.4

TYPICAL PERFORMANCE CHARACTERISTICS

TEMPERATURE CHARACTERISTICS

———— TMC 16V, 1 μ f
----- TMC 16V, 3.3 μ f

TEMPERATURE CHARACTERISTICS

———— TMC 20V, 0.68 μ f
----- TMC 20V, 2.2 μ f

CAPACITANCE VS. TEMPERATURE

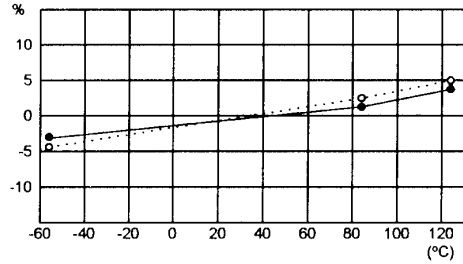

CAPACITANCE VS. FREQUENCY

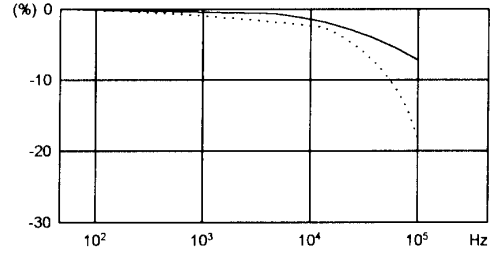

DISSIPATION FACTOR VS. TEMPERATURE

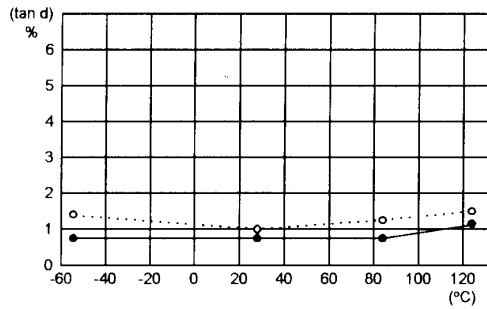

DISSIPATION FACTOR VS. FREQUENCY

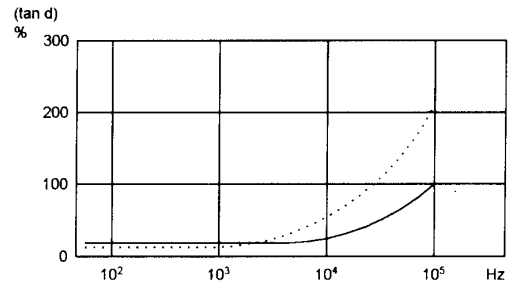

LEAKAGE CURRENT VS. FREQUENCY

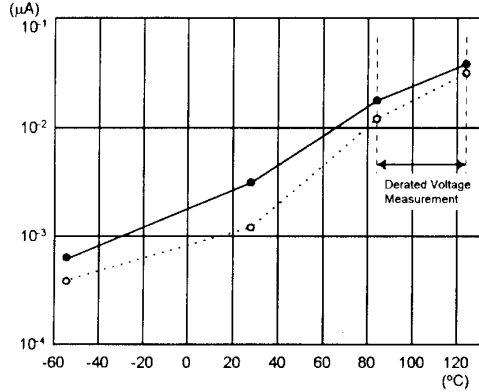

IMPEDANCE VS. FREQUENCY

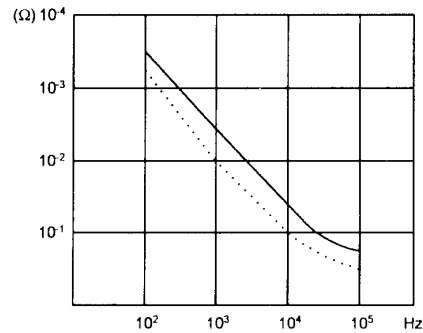

4. Characteristics

4.1 Electrical characteristics

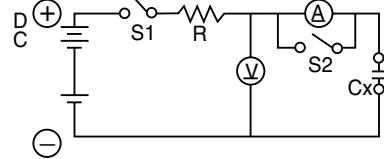
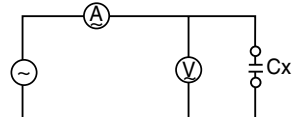
No.	Items	Requirement	Test Method Guideline										
1	Rated Voltage	2.5V to 50VDC	-55°C to +85°C										
2	Maximum Permissible Ripple Voltage	Refer to page 18	Keep the sum of peak DC voltage and ripple voltage within the rated voltage and never go over it.										
3	Nominal Capacitance	0.10μF to 470μF (±10% or ±20%)	Measuring frequency: 120 ± 12Hz Measuring voltage: 0.5Vrms +0.5 ~ 2.0 VDC Measurement circuit: Equivalent series circuit 										
4	Dissipation Factor (DF) Tangent of Loss Angle (tan δ)	See technical data tables for details.	Measurement shall be made under the same conditions as those given for the measurement of capacitance.										
5	D.C. Leakage Current (CC)	Less than 0.01CV(μA) or 0.5 (μA), whichever is the greater. C=nominal capacitance (μF) V=rated voltage (VDC)	Apply the rated voltage through 1000 ±100Ω protective resistor, and measure the current after 5 minutes voltage application.  R : Series Protective Resistor Ⓐ : DC Current Meter or Electronic Current Meter Ⓥ : DC Voltage Meter S1 : Switch S2 : Protective Switch for Current Meter Cx : Capacitor Sample										
6	Impedance High Frequency	<table border="1"> <thead> <tr> <th>Capacitance (μF)</th> <th>Impedance Value</th> </tr> </thead> <tbody> <tr> <td>Less than 0.47</td> <td>—</td> </tr> <tr> <td>0.68 to 1.5</td> <td>Less than 20Ω</td> </tr> <tr> <td>2.2 to 6.8</td> <td>Less than 10Ω</td> </tr> <tr> <td>More than 10</td> <td>Less than 4Ω</td> </tr> </tbody> </table> <p>Cx : Capacitor Sample Ⓢ : AC Power Source Ⓐ : AC Current Meter Ⓥ : AC Voltage Meter</p>	Capacitance (μF)	Impedance Value	Less than 0.47	—	0.68 to 1.5	Less than 20Ω	2.2 to 6.8	Less than 10Ω	More than 10	Less than 4Ω	AC voltage (0.5Vrms or less) of a frequency specified below, shall be applied and the voltage drop across the capacitor terminals shall be measured. The impedance shall be calculated by the following equation. Frequency: 100 ± 10kHz Impedance: (Z) = E/I where E: Voltage drop across the capacitor terminals I: Current flowing through the capacitor 
Capacitance (μF)	Impedance Value												
Less than 0.47	—												
0.68 to 1.5	Less than 20Ω												
2.2 to 6.8	Less than 10Ω												
More than 10	Less than 4Ω												

4. Characteristics

4.1 Electrical Characteristics

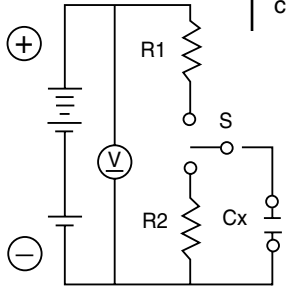
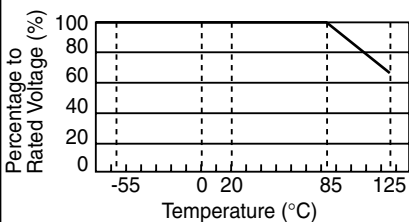
No.	Items	Requirement	Test Method Guideline																																																						
7	Temperature Characteristics	<table border="1"> <thead> <tr> <th>Step</th> <th>Temperature</th> <th>Duration</th> </tr> </thead> <tbody> <tr> <td>1</td> <td>20 ± 2°C</td> <td>—</td> </tr> <tr> <td>2</td> <td>-55 ± 3°C</td> <td>2 hours</td> </tr> <tr> <td>3</td> <td>20 ± 2°C</td> <td>0.25 hours</td> </tr> <tr> <td>4</td> <td>85 ± 2°C</td> <td>2 hours</td> </tr> <tr> <td>5</td> <td>125 ± 2°C</td> <td>2 hours</td> </tr> </tbody> </table> <table border="1"> <caption>Table 3</caption> <thead> <tr> <th>Capacitance (μF)</th> <th>-55°C</th> <th>+85°C</th> <th>+125°C</th> </tr> </thead> <tbody> <tr> <td>0.047 to 1.0</td> <td>Less than 0.09</td> <td>Less than 0.07</td> <td>Less than 0.09</td> </tr> <tr> <td>1.5 to 6.8</td> <td>Less than 0.10</td> <td>Less than 0.08</td> <td>Less than 0.10</td> </tr> <tr> <td>10 to 470</td> <td>Less than 0.12</td> <td>Less than 0.10</td> <td>Less than 0.12</td> </tr> </tbody> </table> <p>Step 1: Capacitance and tangent of loss angle shall be measured. Step 2: After the capacitor has been stored for 2 hours, capacitance and tangent of loss angle shall be measured. The measurement shall be made at thermal equilibrium. Step 4, 5: After the capacitor has been stored for 2 hours, capacitance, tangent of loss angle and leakage current shall be measured. The measurement shall be made a thermal equilibrium. However, measurement shall be made at a temperature derating voltage in step 5.</p>	Step	Temperature	Duration	1	20 ± 2°C	—	2	-55 ± 3°C	2 hours	3	20 ± 2°C	0.25 hours	4	85 ± 2°C	2 hours	5	125 ± 2°C	2 hours	Capacitance (μF)	-55°C	+85°C	+125°C	0.047 to 1.0	Less than 0.09	Less than 0.07	Less than 0.09	1.5 to 6.8	Less than 0.10	Less than 0.08	Less than 0.10	10 to 470	Less than 0.12	Less than 0.10	Less than 0.12	<table border="1"> <tbody> <tr> <td rowspan="2">Step 2</td> <td>Change in capacitance</td> <td>Relative to the value in step 1 - 10 to 0%</td> </tr> <tr> <td>Tangent of loss angle</td> <td>Not more than the value in Table 3</td> </tr> <tr> <td rowspan="2">Step 4</td> <td>Change in capacitance</td> <td>Relative to the value in step 1 - 0 to +10%</td> </tr> <tr> <td>Leakage current</td> <td>0.1CV or 5 μ A or less</td> </tr> <tr> <td rowspan="3">Step 5</td> <td>Tangent of loss angle</td> <td>Not more than the value in Table 3</td> </tr> <tr> <td>Change in capacitance</td> <td>Relative to the value in step 1 - 0 to +12%</td> </tr> <tr> <td>Leakage current</td> <td>0.125CV or 6.25 μ A or less</td> </tr> <tr> <td></td> <td>Tangent of loss angle</td> <td>Not more than the value in Table 3</td> </tr> </tbody> </table>	Step 2	Change in capacitance	Relative to the value in step 1 - 10 to 0%	Tangent of loss angle	Not more than the value in Table 3	Step 4	Change in capacitance	Relative to the value in step 1 - 0 to +10%	Leakage current	0.1CV or 5 μ A or less	Step 5	Tangent of loss angle	Not more than the value in Table 3	Change in capacitance	Relative to the value in step 1 - 0 to +12%	Leakage current	0.125CV or 6.25 μ A or less		Tangent of loss angle	Not more than the value in Table 3
Step	Temperature	Duration																																																							
1	20 ± 2°C	—																																																							
2	-55 ± 3°C	2 hours																																																							
3	20 ± 2°C	0.25 hours																																																							
4	85 ± 2°C	2 hours																																																							
5	125 ± 2°C	2 hours																																																							
Capacitance (μF)	-55°C	+85°C	+125°C																																																						
0.047 to 1.0	Less than 0.09	Less than 0.07	Less than 0.09																																																						
1.5 to 6.8	Less than 0.10	Less than 0.08	Less than 0.10																																																						
10 to 470	Less than 0.12	Less than 0.10	Less than 0.12																																																						
Step 2	Change in capacitance	Relative to the value in step 1 - 10 to 0%																																																							
	Tangent of loss angle	Not more than the value in Table 3																																																							
Step 4	Change in capacitance	Relative to the value in step 1 - 0 to +10%																																																							
	Leakage current	0.1CV or 5 μ A or less																																																							
Step 5	Tangent of loss angle	Not more than the value in Table 3																																																							
	Change in capacitance	Relative to the value in step 1 - 0 to +12%																																																							
	Leakage current	0.125CV or 6.25 μ A or less																																																							
	Tangent of loss angle	Not more than the value in Table 3																																																							
8	Surge Test	<p>The capacitor shall be subjected to the surge voltage as specified below in a cycle of 6±0.5min. which consists of a charge period of 30±5 sec. followed by a discharge period of approx. 5 min. 30 sec. at 85±2°C for 1000 cycles. The capacitor shall be stored under standard atmospheric conditions to obtain thermal equilibrium, after which measurement shall be made.</p>  <p>R1: Series Protective Resistor (33Ω) R2: Discharge Resistor (33Ω) V: DC Voltmeter Cx: Test Capacitor S: Switch</p>	<table border="1"> <tbody> <tr> <td>Change in capacitance</td> <td>Relative to the value before test +5%</td> </tr> <tr> <td>Tangent of loss angle</td> <td>Clause 4.1.4 shall be satisfied</td> </tr> <tr> <td>Leakage current</td> <td>Clause 4.1.5 shall be satisfied</td> </tr> </tbody> </table> <table border="1"> <tbody> <tr> <td>Rated voltage (V)</td> <td>2.5</td> <td>4</td> <td>7</td> <td>10</td> <td>16</td> <td>20</td> <td>25</td> <td>35</td> <td>50</td> </tr> <tr> <td>Surge voltage (V)</td> <td>3.2</td> <td>5</td> <td>8</td> <td>13</td> <td>20</td> <td>26</td> <td>32</td> <td>45</td> <td>63</td> </tr> </tbody> </table>	Change in capacitance	Relative to the value before test +5%	Tangent of loss angle	Clause 4.1.4 shall be satisfied	Leakage current	Clause 4.1.5 shall be satisfied	Rated voltage (V)	2.5	4	7	10	16	20	25	35	50	Surge voltage (V)	3.2	5	8	13	20	26	32	45	63																												
Change in capacitance	Relative to the value before test +5%																																																								
Tangent of loss angle	Clause 4.1.4 shall be satisfied																																																								
Leakage current	Clause 4.1.5 shall be satisfied																																																								
Rated voltage (V)	2.5	4	7	10	16	20	25	35	50																																																
Surge voltage (V)	3.2	5	8	13	20	26	32	45	63																																																
9	Temperature Derated Voltage	<p>When operating at an ambient temperature range from 85°C to 125°C, the operation shall be carried out at a derating voltage or less as shown below.</p>  <p>Derating voltage V_t at any temperature T between 85°C and 125°C shall be calculated by the following formula:</p> $V_t = V_r - \frac{V_r - V_d}{40} (T - 85)$ <p>V_r: Rated voltage V_d: Derating voltage at 125°C</p>	<table border="1"> <tbody> <tr> <td>Rated voltage (V)</td> <td>2.5</td> <td>4</td> <td>7</td> <td>10</td> <td>16</td> <td>20</td> <td>25</td> <td>35</td> <td>50</td> </tr> <tr> <td>Derating voltage at 125°C (V)</td> <td>1.6</td> <td>2.5</td> <td>4</td> <td>6.3</td> <td>10</td> <td>13</td> <td>16</td> <td>22</td> <td>32</td> </tr> </tbody> </table>	Rated voltage (V)	2.5	4	7	10	16	20	25	35	50	Derating voltage at 125°C (V)	1.6	2.5	4	6.3	10	13	16	22	32																																		
Rated voltage (V)	2.5	4	7	10	16	20	25	35	50																																																
Derating voltage at 125°C (V)	1.6	2.5	4	6.3	10	13	16	22	32																																																

4. Characteristics

4.2 Endurance Characteristics (continued)

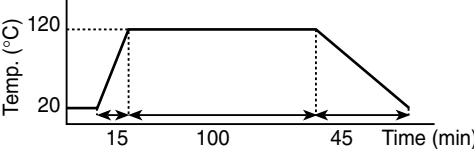
No.	Items	Conditions	Specifications	
1	Solderability	Test Temperature: 235 ± 5°C for 2 ± 0.5 seconds. Others are based on JIS C 5102 clause 8.4. (Test Method is according to Clause 1.)	A new uniform coating of solder shall cover a minimum of 75% of the surface being immersed.	
2	Resistance to Soldering Heat	The methods are in accordance with JIS C 5143 Appendix I and II. After preheat of 5 minutes at 150°C. Immersion at 260 ± 5°C 10 ± 1 seconds for A, B cases. 5 ± 0.5 seconds for C, D, E cases. Reflow at 260 ± 5°C 10 ± 1 seconds. <u>Soldering iron method</u> (1) 25 watt soldering iron: Less than 3 seconds at one side with 350 ⁺⁰ ₋₁₀ °C (2) 30 watt soldering iron: Less than 3 seconds at one side with 300±10°C Re-soldering shall be one time only.	Change in capacitance	Relative to the value before test ±5%
			Tangent of loss angle	Clause 4.1.4 shall be satisfied
			Leakage current	Clause 4.1.5 shall be satisfied
			Appearance	There shall be no deformation of case or distinct looseness of electrodes
3	Surface Mounting by Soldering (2 times) ↓ Screening to Heat	After surface mounting by soldering (2 times), if you do screening to heat capacitors, it is for temperature process to establish to under drawing of Temperature - Time. Leaving them for 1~2 hours later, you measure them. 	Change in capacitance	Relative to the value before test ±10%
			Tangent of loss angle	Clause 4.1.4 shall be satisfied
			Leakage current	Not more than 125% of initial value (Clause 4.1.5)
			Appearance	No remarkable abnormality and markings shall be legible
4	Vibration	The TMC capacitors will withstand 6 hours of vibration testing, 2 hours in each of three mutually perpendicular planes. The frequency will vary from 10 Hz to 55 Hz and back to 10 Hz over a one minute period, continuously during each 2 hour test, with a total excursion of 1.5 mm. During the last 30 minutes of vibration, in each direction, electrical tests shall be conducted.	Change in capacitance	Within +5% of initial value
			Tangent of loss angle	Within initial value specified
			Leakage Current	Within initial value specified
			Appearance	All markings shall be legible, no abnormalities
5	Damp Heat (steady state)	The capacitor shall be stored at a temperature of 40 ± 2°C and relative humidity of 90% to 95% for 500 ⁺²⁴ ₀ hours. Then the capacitor shall be subjected to standard atmospheric conditions for 1 to 2 hours, after which measurements shall be made.	Change in capacitance	Relative to the value before test ±10%
			Tangent of loss angle	Clause 4.1.4 shall be satisfied
			Leakage	Clause 4.1.5 current shall be satisfied
			Appearance	No remarkable abnormality and markings shall be legible

4. Characteristics

4.2 Endurance Characteristics (continued)

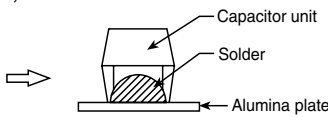
No.	Items	Conditions	Specifications																
6	Electrical Endurance	Testing is conducted for 2,000 hours @ 85°C±2°C with the rated voltage applied through a 3Ω series protective resistor. Measurements will be taken after stabilization for 1 to 2 hours, at room temperature. The readings shall comply with the required specifications.	Change in capacitance	Relative to the value before test ±10%															
			Tangent of loss angle	Clause 4.1.4 shall be satisfied															
			Leakage current	Not more than 125% of initial value (Clause 4.1.5)															
			Appearance	No remarkable abnormality and markings shall be legible															
7	Change in Temperature	The capacitor shall be subjected to each specified temperature for each specified period shown in the table below. These 4 steps constitutes one rotation. 5 continuous rotations shall be carried out.	Change in capacitance	Relative to the value before test ±10%															
			Tangent of loss angle	Clause 4.1.4 shall be satisfied															
			Leakage current	Clause 4.1.5 shall be satisfied															
			<table border="1"> <thead> <tr> <th>Step</th> <th>Temperature (°C)</th> <th>Duration</th> </tr> </thead> <tbody> <tr> <td>1</td> <td>-55 ± 3</td> <td>30 ± 3 min</td> </tr> <tr> <td>2</td> <td>Normal temperature</td> <td>3 max</td> </tr> <tr> <td>3</td> <td>125 ± 2</td> <td>30 ± 3 min</td> </tr> <tr> <td>4</td> <td>Normal temperature</td> <td>3 max</td> </tr> </tbody> </table>		Step	Temperature (°C)	Duration	1	-55 ± 3	30 ± 3 min	2	Normal temperature	3 max	3	125 ± 2	30 ± 3 min	4	Normal temperature	3 max
			Step	Temperature (°C)	Duration														
1	-55 ± 3	30 ± 3 min																	
2	Normal temperature	3 max																	
3	125 ± 2	30 ± 3 min																	
4	Normal temperature	3 max																	
Change in capacitance	Relative to the value before test ±10%																		
8	Resistance to Damp Heat	Expose the capacitor to 40 ± 2°C at 90~95% RH and apply DC voltage equal to rated voltage through 1K ohm series protective resistor 500 ±12 hours. Then expose it for 4 hours in the standard atmospheric conditions and then, carry out the measurement.	Change in capacitance	Relative to the value before test ±10%															
9	Terminal Strength	The capacitor soldered to the alumina plate, is pushed sideways horizontally with 1.5Kg.F tensile load as shown below. For the other procedures, refer to JIS C 5143 accessories note 3.	Tangent of loss angle	Not more than 150% of initial value (Clause 4.1.4)															
			Leakage current	Not more than 200% of initial value (Clause 4.1.5)															
			Appearance	No remarkable abnormality and markings shall be legible															
			There will be no evidence of mechanical degradation in terminals and the unit.																
10	Resistance to Solvent	<p>(1) Cleaning by Immersion I Solvent: IPA Immersion time: 5±1 minutes Temperature: 20~25°C</p> <p>(2) Cleaning by Immersion II Solvent: Water Immersion time: 5±1 minutes Temperature: 55±5°C</p> <p>(3) Ultrasonic cleaning Frequency: 25±4kHz or 40⁺⁸₋₄ kHz Output power: Less than 20W/l Time: 5 minutes Temperature-IPA: 20~25°C Water: 55±5°C</p>	Change in capacitance	Relative to the value before test +3%															
			Tangent of loss angle	Clause 4.1.4 shall be satisfied															
			Leakage current	Clause 4.1.5 shall be satisfied															
			Appearance	No abnormality between the capacitor and terminals.															
																			

5. Markings

5.1 Marking Methods

Markings are printed on the surface of the capacitor unit.

Table 4-Examples of markings on the unit

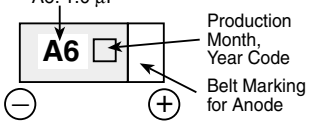
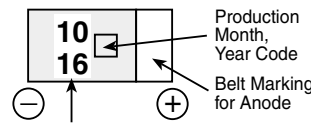
A, B cases	C, E cases	Lot Number Symbol																																																																														
<p>Abbreviated Capacitance A6: 1.0 μF</p> 	 <p>Upper number indicates capacitance in μF. Lower number indicates rated voltage (16V).</p>	<table border="1"> <tr> <td>Month</td> <td>1</td><td>2</td><td>3</td><td>4</td><td>5</td><td>6</td><td>7</td><td>8</td><td>9</td><td>10</td><td>11</td><td>12</td> </tr> <tr> <td>Year</td> <td></td><td></td><td></td><td></td><td></td><td></td><td></td><td></td><td></td><td></td><td></td><td></td> </tr> <tr> <td>1999</td> <td>a</td><td>b</td><td>c</td><td>d</td><td>e</td><td>f</td><td>g</td><td>h</td><td>j</td><td>k</td><td>l</td><td>m</td> </tr> <tr> <td>2000</td> <td>n</td><td>p</td><td>q</td><td>r</td><td>s</td><td>t</td><td>u</td><td>v</td><td>w</td><td>x</td><td>y</td><td>z</td> </tr> <tr> <td>2001</td> <td>A</td><td>B</td><td>C</td><td>D</td><td>E</td><td>F</td><td>G</td><td>H</td><td>J</td><td>K</td><td>L</td><td>M</td> </tr> <tr> <td>2002</td> <td>N</td><td>P</td><td>Q</td><td>R</td><td>S</td><td>T</td><td>U</td><td>V</td><td>W</td><td>X</td><td>Y</td><td>Z</td> </tr> </table> <p>1999 Jan. fix as Code "a" and alphabetical order follows. (I, i, O, o are not being used)</p>	Month	1	2	3	4	5	6	7	8	9	10	11	12	Year													1999	a	b	c	d	e	f	g	h	j	k	l	m	2000	n	p	q	r	s	t	u	v	w	x	y	z	2001	A	B	C	D	E	F	G	H	J	K	L	M	2002	N	P	Q	R	S	T	U	V	W	X	Y	Z
Month	1	2	3	4	5	6	7	8	9	10	11	12																																																																				
Year																																																																																
1999	a	b	c	d	e	f	g	h	j	k	l	m																																																																				
2000	n	p	q	r	s	t	u	v	w	x	y	z																																																																				
2001	A	B	C	D	E	F	G	H	J	K	L	M																																																																				
2002	N	P	Q	R	S	T	U	V	W	X	Y	Z																																																																				

5.2 Label Descriptions in minimum package unit

- (1) Manufacturer's Name (2) Production Lot Number (3) Part Number (4) Rated Voltage
(5) Nominal Capacitance Value (6) Nominal Capacitance Tolerance (7) Quantity

Table-5 Tables of printed markings

WV cap	2.5	4	7	10	16	20	25	35	50
	0E	0G	0J	1A	1C	1D	1E	1V	1H
0.10								104	A5
0.15								154	E5
0.22								224	J5
0.33								N5	N5
0.47							S5	VS5	HS5 0.47 50
0.68						W5	EW5	VW5	HW5 0.68 50
1.0					A6	DA6	EA6	VA6	1 50
1.5				E6	CE6	DE6	EE6	VE6 1.5 35	1.5 50
2.2			J6	AJ6	CJ6	DJ6	EJ6	VJ6 2.2 35	2.2 50
3.3		N6	JN6	AN6	CN6	DN6	EN6	VN6 3.3 35	3.3 50
4.7		GS6	JS6	AS6	CS6	DS6	ES6 4.7 25	4.7 35	4.7 50
6.8	eW6	GW6	JW6 W6	AW6	CW6	DW6 6.8 20	6.8 25	6.8 35	
10	eA7	GA7 A7	JA7	AA7	CA7 10 16	DA7 10 20	10 25	10 35	
15	eE7	GE7	JE7	AE7 15 10	CE7 15 16	15 20	15 25	15 35	
22	eJ7	GJ7	JJ7 22 7	AJ7 22 10	CJ7 22 16	22 20	22 25		
33	eN7	GN7 33 4	JN7 33 7	AN7 33 10	33 16	33 20			
47	eS7	GS7 47 4	JS7 47 7	47 10	47 16	47 20			
68	eW7 68 2.5	GW7 68 4	68 7	68 10	68 16				
100	eA8 100 2.5	100 4	100 7	100 10	100 16				
150	150 2.5	150 4	150 7	150 10					
220	220 2.5	220 4	220 7	220 10					
330	330 2.5	330 4	330 7						
470	470 2.5	470 4							

Refer to pages 2 & 3 for case sizes.

5.3 Marking Methods (P series only)

Markings are printed on the surface of the capacitor unit.

Examples of marking

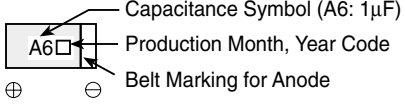
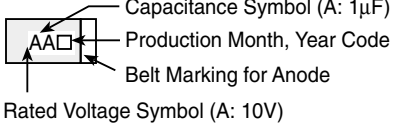
<p>6.3V1μF</p> 	<ul style="list-style-type: none"> ■ In case that simple capacitance symbol is same as case size, rated voltage symbol is marking on higher voltage one. ■ When marking the symbol of rated voltage and capacitance, a multiplier of capacitance symbol is omitted. ■ Simple symbol is referenced to JIS C 5143 clause 10, and EIAJ RC-3813 clause 7.1.
<p>10V1μF</p> 	

5.4 3-2 Label Descriptions in Minimum Package Unit

- (1) Manufacturer's Name (2) Production Lot Number (3) Part Number (4) Rated Voltage
 (5) Nominal Capacitance (6) Nominal Capacitance Tolerance (7) Quantity

Table 5.A1-Table of Rated Values and Marking

V,DC μ F	2.5	4	6.3	10	16	20	25	CAP CODE
	OE	OG	OJ	1A	1C	1D	1E	
0.047							ES □	473
0.068							EW □	683
0.10						DA □		104
0.15						DE □		154
0.22						DJ □		224
0.33						DN □		334
0.47					S5 □	DS □		474
0.68				W5 □	CW □	DW □		684
1.0			A6 □	AA □	CA □			105
1.5		E6 □	JE □	AE □				155
2.2	J6 □	GJ □	JJ □	AJ □				225
3.3	eN □	GN □	JN □	AN □				335
4.7	eS □	GS □	JS □	AS □				475
6.8	eW □	GW □	JW □					685
10	eA □	GA □	JA □					106
15	eE □	GE □						156
22	eJ □	GJ □						226

Refer to Page 2 for case sizes.

6. Quality

6.1 Failure Rate

Not more than 1.0% per 1,000 hours

6.2 Series Circuit Resistance

Obtain series circuit resistance from Figure 1 (Percentage of Failure Rate vs. Circuit Resistance) and Figure 2 (Failure Rate Improvement Factors). As Failure Rate is based on $1\Omega/V$ of series circuit resistance, it is 0.38% for 1,000 hours in case of $3\Omega/V$, for example.

6.3 Quality Assurance Requirements

MIL - STD - 105D Inspection level II, Normal inspection, single sampling.

Table 6

Items	AQL
Short, open	0.1%
Capacitance, Dissipation Factor, Leakage Current	0.4%
Appearance Dimensions, Constructions	0.65%

6.4 Endurance Test

Table 7

Group	Items	Sample Quantity	Permissible Number of Defectives
1	Vibration	6	0
2	Solderability Terminal Strength, Humidity Resistance	6	0
3	Stability at Low and High Temperature Surge Voltage	6	0
4	High Temperature Load	6	0
5	Resistance to Soldering Heat	6	0

7. Others

7.1 Based on JIS C 5143 (1991 Edition) Characteristic LB and EIAJ RC 3813 Characteristic B

7.2 Method of Testing: JIS C 5102 (1994 Edition) and EIAJ RC 3813

7. Others (continued)

Figure 1 - Circuit Resistance vs. Percentage of Failure Rate

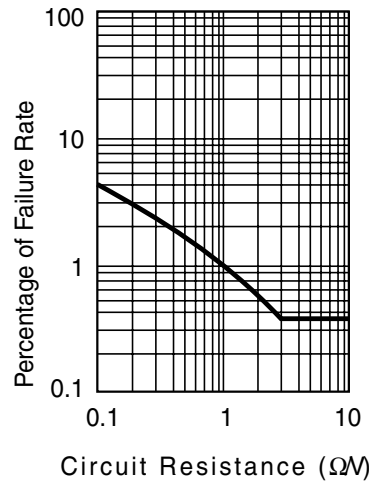
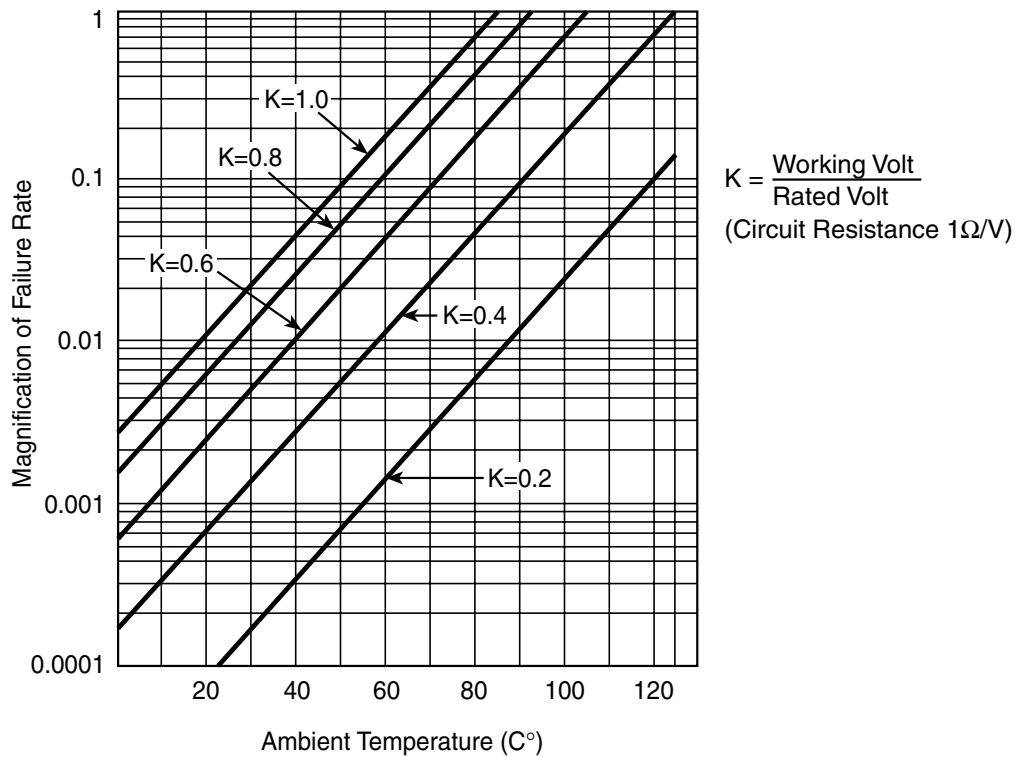

Figure 2 - Failure Rate Improvement Factors



Carrier Tape Packaging Specifications

8. Product Symbol

TMC	OG	A	475	M	L	R	H
Series Code	Rated Voltage	Case Size	Nominal Capacitance	Capacitance Tolerance	Carrier Tape Packaging	Polarity Orientation	Leader Length

9. Dimensions of the carrier tape and standard parts quantity per reel

9.1 Dimensions

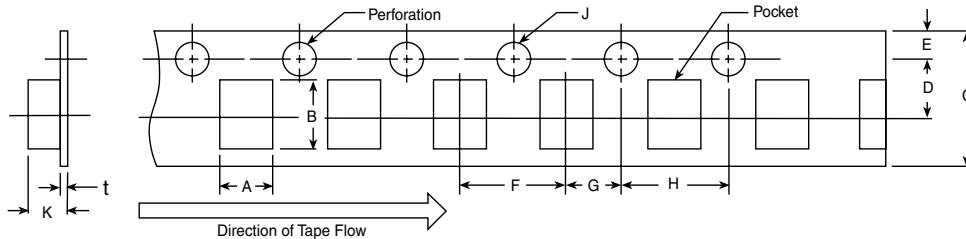

Description	Symbol	CASE SIZE					Tol. %
		P	A	B	C	E	
Pocket Width	A	1.5	1.9	3.1	3.7	4.8	0.1
Pocket Length	B	2.2	3.5	3.9	6.3	7.7	0.1
Pocket Pitch	F	4.0	4.0	4.0	8.0	8.0	0.1
Feed Hole Pitch	H	4.0	4.0	4.0	4.0	4.0	0.1
Feed Hole Diameter	J	1.5	1.5	1.5	1.5	1.5	+0.1-0.0
Feed Hole Position	E	1.75	1.75	1.75	1.75	1.75	0.1
Feed Hole to Pocket Center	D	3.5	3.5	3.6	5.5	5.5	0.1
	G	2.0	2.0	2.0	2.0	2.0	0.1
Tape Width	C	8.0	8.0	8.0	12.0	12.0	0.3
Tape Thickness	T	0.2	0.2	0.2	0.3	0.3	MAX
Overall Thickness	K	1.6	2.5	2.5	3	3.4	MAX

9.2 Inserting Direction (Polarity Orientation)

Polarity L: To be inserted with the positive side to the feed hole.

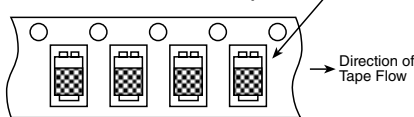

Polarity R: To be inserted with the negative side to the feed hole.

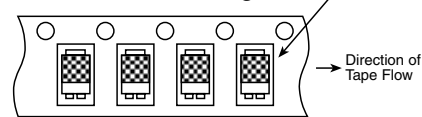

9.3 Reel Dimensions

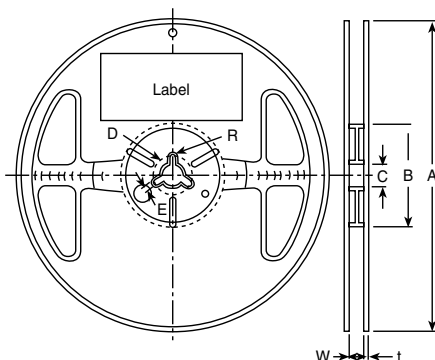

(Unit: mm)

Tape width	8	12
A $\begin{smallmatrix} 0 \\ -3 \end{smallmatrix}$	∅ 180	←
B $\begin{smallmatrix} +1 \\ 0 \end{smallmatrix}$	∅ 60	←
C ± 0.2	∅ 13	←
D ± 0.8	∅ 21	←
E ± 0.5	2.0	←
W ± 0.3	9.0	13.0
t ± 0.4	1.3	←
R ± 0.4	10.5	←

9.4 Tape leader and Trailer

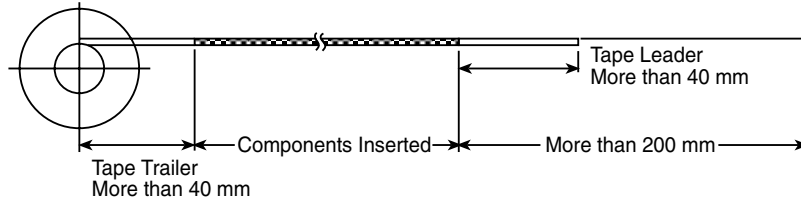

10. Packaging Specifications

10.1 Peel - off Strength of Cover Tape

In the following method, $F = 0.294 \pm 0.196N$ shall be maintained, when cover tape is peeled off.

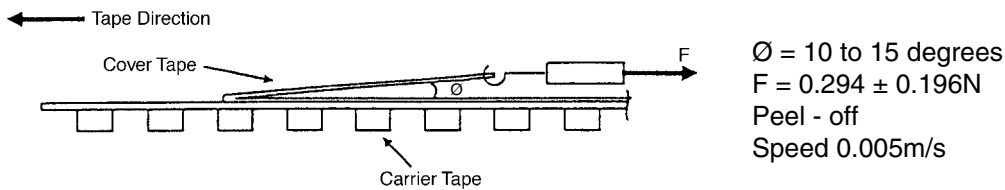

10.2 Component Insertion on Reel

- (1) It is required that the number of empty places in the tape per reel shall not exceed two per 1,000 pcs without consecutive empty places.
- (2) Components in the tape are to be prevented from overturning, reverse turning and side turning in the pocket holes.

10.3 Splicing (Cover Tape)

The method of correcting improperly inserted component on reel.

- (A) Cut three sides of a cover tape over the pocket hole where the component is improperly inserted and put the transparent adhesive tape on it. The adhesive tape shall not go over the sealing width of a cover tape.

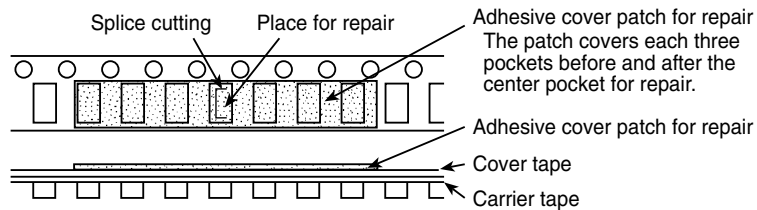

11. Marking on Reel

Principally, markings on reel cover following items on label.

- | | |
|-----------------------------------|---------------------------|
| (1) Nominal Capacitance Value | (5) Production Lot Number |
| (2) Nominal Capacitance Tolerance | (6) Manufacturer's Name |
| (3) Rated Voltage | (7) Product Type Symbol |
| (4) Quantity | |

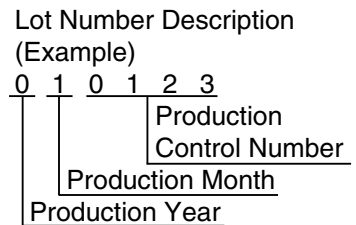

12. Materials of Tape and Reel

- (1) Reel (Shape and dimensions as per 2.3)
- (2) Embossed Carrier (Shape and dimensions as per 2.1)
- (3) Cover tape

13. Packaging

Capacitors must be packaged prior to shipment so as to prevent damage during transportation or storage. The period of storage at a normal room temperature and humidity is two years after production.

14. Inner Structure and Constituent Materials

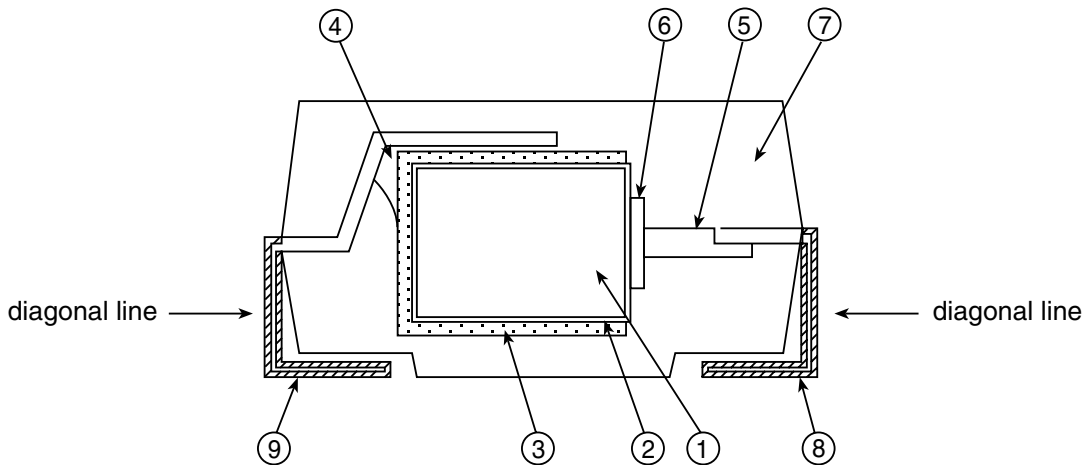

Table - 1

No.	Item	Material	Note
1	Element	Tantalum	
2	Electrolyte	Manganese oxide (MnO ₂)	
3	Cathode layer	Carbon, Silver	
4	Conductive adhesive	Silver	
5	Anode lead wire	Tantalum	
6	Supporter	Teflon	
7	Mold resin	Epoxy	
8	Positive terminal	Nickel silver (0.1t)	Diagonal line: Sn90, Pb10 solder plating
9	Negative terminal	Nickel silver (0.1t)	

15. Handling cautions for use of TMC Type Tantalum Solid Electrolytic Capacitors

15.1 Ripple Voltage

- A. Keep the sum of peak DC voltage and ripple voltage within the rated voltage and never go over it
- B. When ripple voltage applied, use less value than shown below

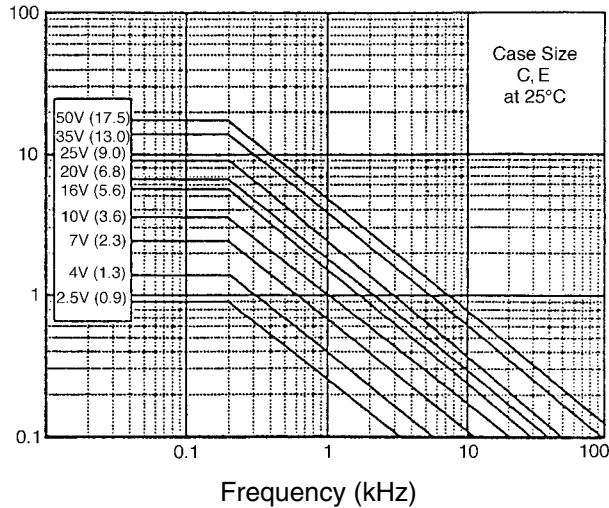
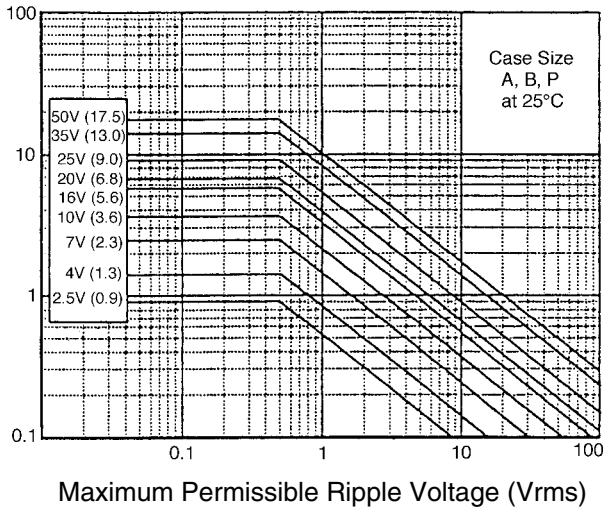

In case of high temperature use, calculate permissible ripple voltage by using the following formula:
 $V_{rms} \text{ (at } 50^{\circ}\text{C)} = 0.7 \times V_{rms} \text{ (at } 25^{\circ}\text{C)}$
 $V_{rms} \text{ (at } 85^{\circ}\text{C)} = 0.5 \times V_{rms} \text{ (at } 25^{\circ}\text{C)}$

15.2 Reverse Polarity Voltage

- A. TMC Type Solid tantalum capacitors are polar and reverse polarity voltage must not be applied. But, for short time application, the peak reverse polarity voltage applied to the capacitor must not exceed:
 at 25°C - 10% of rated voltage or 1V, whichever is smaller.
 at 85°C - 5% of rated voltage or 0.5V, whichever is smaller.
- B. Careless contact of the tester to the capacitor will cause reverse polarity voltage and excessive voltage.

15.3 Voltage Derating

Have voltage derating ratio as large as possible. Especially, in case of low impedance circuit use, not more than 1/3 of rated voltage is recommended. For moment heavy current run like switching or pulse voltage. The value of resistor is recommended to be more than 3 ohms per volt. (Limit to less than 300mA for rush current).

15.4 Applications

A. Limit of Stress

Stress given to the capacitor by sucking tools and centering tweezers must not exceed 4.9N (stress time not more than 5 sec.) with the 1.5Ø point. Especially, the setting position of sucking tools is too low will cause not only overloading to the capacitor, but also wire - snapping on PC boards and scattering of capacitors and other parts, when consolidated mounting with other chip components of less than 1mm in height.

15.4 Applications (continued)

B. Recommended Soldering Pattern Dimensions

The recommended chip soldering pattern dimensions are as shown in Table 2 and Fig. 1. Note, however, that they are affected by such factors as reflow conditions, solder type, and circuit board size. If the pattern area is significantly larger than the capacitor terminal area, the capacitor in place may be displaced when the solder melts.

Fig. 1 - Recommended soldering pattern dimensions

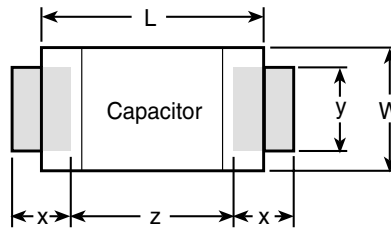

Table 2 - Recommended soldering pattern

Case size	Dimensions	Capacitor size		Pattern dimensions		
		L	W	x	y	z
P		2.0	1.25	1.2	1.1	0.8
A		3.2	1.6	1.6	1.2	1.2
B		3.5	2.8	1.6	2.2	1.4
C		5.8	3.2	2.3	2.4	2.4
E		7.3	4.3	2.3	2.6	3.8

C. Flux

Use login - family flux and avoid the use of strong acid and high activational materials.

D. Solderability

Carry out soldering under following conditions. We recommend soldering at a lower temperature and at a shorter time.

- 1) Soldering Iron
 Temperature at the point of soldering iron: Not higher than +350°C
 Soldering Time: Less than 3 seconds
 Output: Less than 30W
- 2) Reflow (Atmospheric and Hot - Plate)
 Capacitor Body Temperature: Not higher than +260°C
 Time: Not more than 10 seconds

A permissible range for peak temperature and time as per Fig. 2.

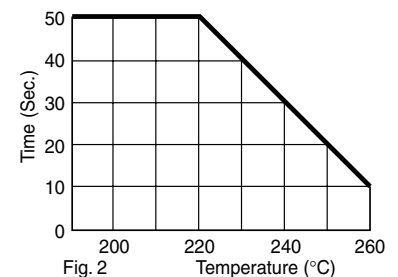
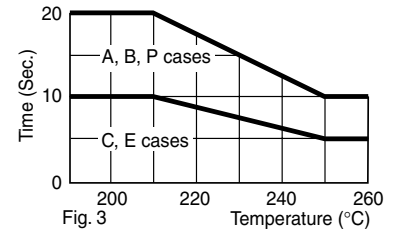

Fig. 2

- a) There is no problem in such a hot - plate heating method which will heat the bottom side, but in case of the top side heating by infra-red, the temperature of capacitor body becomes higher than the surface of PC boards. Caution must be taken.

D. Solderability (*continued*)

- b) In case of near infra-red heating with big power output, sudden temperature increase will occur and preheating at 130°C - 160°C for more than one minute is recommended. Please be sure that the temperature between maximum reflow temperature and the one used will remain less than 100°C
 - c) If solder land is bigger than the capacitor terminal, slipping off of the capacitor in its position will happen. Please take care that this does not happen.
- 3) Solder Immersion
 Solder Bath Temperature: Not higher than 260°C
 Time: A, B, P Cases: Not more than 10 seconds
 C, E Cases: Not more than 5 seconds



A permissible range for peak temperature and time as per Fig. 3

- a) Consideration must be taken to remove “gas” because solderability is sometimes bad for high density of components.
- b) Pre-heat as much as possible and avoid sudden heating to the capacitor. Recommended pre-heat temp. is 130~160°C for more than one minute and the temperature between peak temp. and pre-heat is less than 100°C.

E. Cleaning

Allow board surface temperature to drop to normal temperature fully, after which cleaning shall be made. Usable solvent are as follows:

- Halogen system organic solvent (HCFC225, methylene chloride and the like.)
- Alcohol type solvent (IPA, ethylalcohol and the like.)
- Petroleum type solvent, alkaline saponification agent, water and the like.

Cleaning must be made under the following conditions.

- Temperature: Not higher than +50°C
- Immersion Time: Not more than 30 minutes

In case of ultrasonic cleaning, it must be made with a frequency of less than 45kHz, an output of less than 0.02W/cm³ within 5 minutes at less than +40°C.

- 1) Ultrasonic cleaning should be avoided as much as possible, but when above cleaning is carried out, please see to it that mounted capacitors do not bump against other parts and no hard brush will be used to rub circuit boards.
- 2) Ultrasonic cleanings mentioned above are based on thyristor - inverter method. So, for cleanings with other methods, please carry out much of pre-tests.

F. Conductive Adhesive

The use of conductive adhesive for capacitor mounting should be avoided. Please consult KOA Speer for use if necessary.

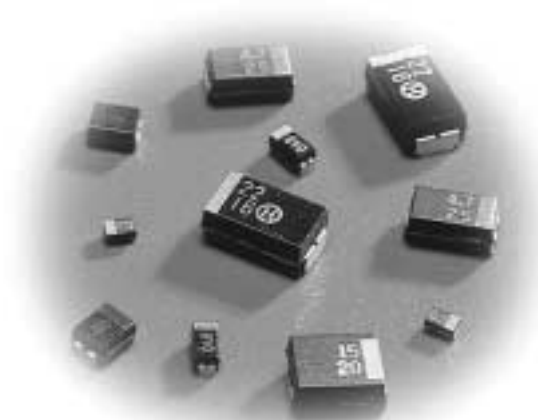

features

- Epoxy molded body, UL94V-0 flammability
- EIA - US and EIA - Japan compatible sizes
- 100% burn-in and end-of-line testing
- Extended values per case size
- Excellent humidity and solder resistance
- Marking: Black body color with white marking

dimensions and construction

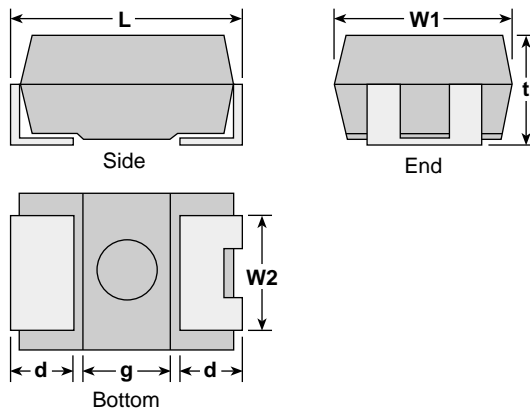

Case Size (Inch Size Code)	Dimensions inches (mm)					
	L	W1	W2	t	d	g
P (2012)	.079±.008 (2.0±0.2)	.049±.008 (1.25±0.2)	.035±.004 (0.9±0.1)	.047 Max. (1.2 Max.)	.020±.012 (0.5±0.3)	.031 Min. (0.8 Min.)
A (3216)	.126±.008 (3.2±0.2)	.063±.008 (1.6±0.2)	.047±.008 (1.2±0.2)	.063±.008 (1.6±0.2)	.028±.012 (0.7±0.3)	.055±.008 (1.4±0.2)
B (3528)	.138±.008 (3.5±0.2)	.110±.008 (2.8±0.2)	.087±.008 (2.2±0.2)	.073±.008 (1.9±0.2)	.031±.012 (0.8±0.3)	.055±.008 (1.4±0.2)
C (6032)	.236±.012 (6.0±0.3)	.126±.008 (3.2±0.2)	.087±.008 (2.2±0.2)	.098±.008 (2.5±0.2)	.051±.012 (1.3±0.3)	.094±.008 (2.4±0.2)
E (EIA-D)	.287±.012 (7.3±0.3)	.169±.012 (4.3±0.3)	.094±.004 (2.4±0.1)	.110±.008 (2.8±0.2)	.051±.012 (1.3±0.3)	.15±.008 (3.8±0.2)

tantalum chip capacitors

ordering information

Old Part #	TMC	1E	C	475	M	L	R	H
	Type	Voltage Code	Case Size	Nominal Capacitance	Tolerance	Packaging	Polarity Orientation	Leader Length Cover/Carrier
New Part #	TMC	1E	C	L	TE	475	M	R
	Type	Voltage Code	Case Size	Termination Material	Packaging	Nominal Capacitance	Tolerance	Polarity Orientation
		0E: 2.5V 0G: 4V 0J: 7V 1A: 10V 1C: 16V 1D: 20V 1E: 25V 1V: 35V 1H: 50V	P: 2012 A: 3216 B: 3528 C: 6032 E: EIA-D	L: SnPb T: Sn	TE: 7" embossed plastic	Reference capacitance ranges and case sizes chart	K: ±10% M: ±20%	

For further information on packaging, please refer to Appendix A.

Specifications given herein may be changed at any time without prior notice. Please confirm technical specifications before you order and/or use.

capacitance ranges and case sizes

Standard Range

STANDARD VALUES VOLTAGE CODE		0G	0J	1A	1C	1D	1E	1V	1H
85°C	Rated Voltage (VDC)	4	7	10	16	20	25	35	50
	Surge Voltage (VDC)	5	9	13	20	26	32	46	63
125°C	Derated Voltage (VDC)	2.5	4	6.3	10	13	16	23	32
Capacitance (µF)	Capcode								
0.1	104							A	A
0.15	154							A	B
0.22	224							A	B
0.33	334							A	B
0.47	474						A	B	C
0.68	684				A			B	C
1.0	105			A				B	C
1.5	155			A			B	C	E
2.2	225		A			B		C	E
3.3	335	A			B			C	
4.7	475			B			C	E	
6.8	685		B			C		E	
10	106	A,B			C		E		
15	156			C		E			
22	226		C		E				
33	336	C		E					
47	476		E						
68	686	E							

Extended Range

STANDARD VALUES VOLTAGE CODE		0E	0G	0J	1A	1C	1D	1E	1V	1H
85°C	Rated Voltage (VDC)	2.5	4	7	10	16	20	25	35	50
	Surge Voltage (VDC)	3.2	5	9	13	20	26	32	46	63
125°C	Derated Voltage (VDC)	1.6	2.5	4	6.3	10	13	16	23	32
Capacitance (µF)	Capcode									
.047	473								P	
.068	683								P	
.1	104							P	A	A
.15	154							P	A	A,B
.22	224							P	A	A,B
.33	334							P	A	B
.47	474							P	A	A,B
.68	684				P	P	A,P	A	A,B	B,C
1.0	105			P	P	A,P	A	A	A,B	C
1.5	155			P	P	A,P	A	A	A,B	C,E
2.2	225		P	P	A,P	A,P	A	A,B	B	B,C
3.3	335		P	A,P	A,P	A,P	A,B	A,B	B	B,C
4.7	475		P	A,P	A,P	A,B,P	A,B	A,B,C	B,C	C,E
6.8	685		A,P	A,P	A,B,P	A,B,C	A,B	B,C	C	C,E
10	106		A,P	A,B,P	A,B,P	A,B,C	A,B,C	B,C	C,E	E
15	156		A,P	A,B,P	A,B	B,C	A,B,C	C,E	C,E	E
22	226		A,B,P	A,B,P	A,B,C	B,C	B,C,E	C,E	E	
33	336		A,B	A,B,C	A,B,C	B,C,E	C,E	E		
47	476		B	A,B,C	A,B,C	B,C,E	C,E	E		
68	686		B,C	B,C,E	B,C,E	C,E	E			
100	107		B,C	B,C,E	B,C,E	C,E	E			
150	157		C,E	C,E	C,E	C,E				
220	227		C,E	C,E	E	E				
330	337		E	E	E					
470	477		E	E						

tantalum chip capacitors

part marking

Standard Range

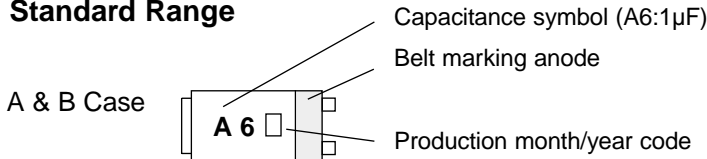

Value (µf)	.1	.15	.22	.33	.47	.68	1.0	1.5	2.2	3.3	4.7	6.8	10.0
Marking	A5	E5	J5	N5	S5	W5	A6	E6	J6	N6	S6	W6	A7

Lot Number Symbol

Lot number symbol is expressed "a" as January 1999 as a starting month and year in an alphabetical order and in a small letter to a capital (Letters of I, i, O, and o are excluded)

Year	Month											
	1	2	3	4	5	6	7	8	9	10	11	12
1999	a	b	c	d	e	f	g	h	j	k	l	m
2000	n	p	q	r	s	t	u	v	w	x	y	z
2001	A	B	C	D	E	F	G	H	J	K	L	M
2002	N	P	Q	R	S	T	U	V	W	X	Y	Z

Extended Range

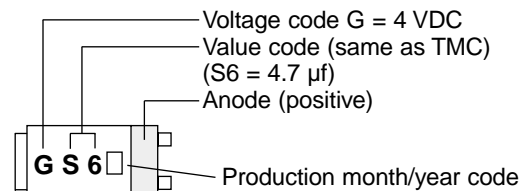
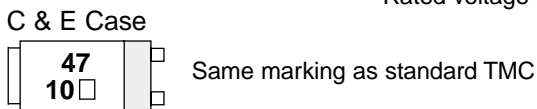
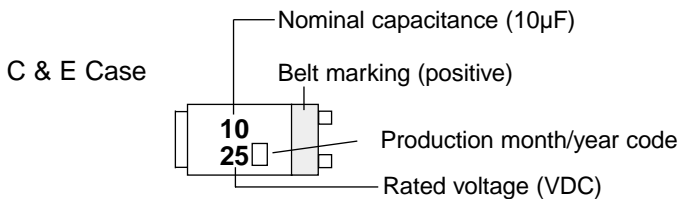

Voltage	2.5	4	7	10	16	20	25	35	50
Marking	e	G	J	A	C	D	E	V	H

Specifications given herein may be changed at any time without prior notice. Please confirm technical specifications before you order and/or use.