

Rev	Description	Date	By
J	ADDED NEW P/N (PER ESR 20106)	11/07/00	VAR

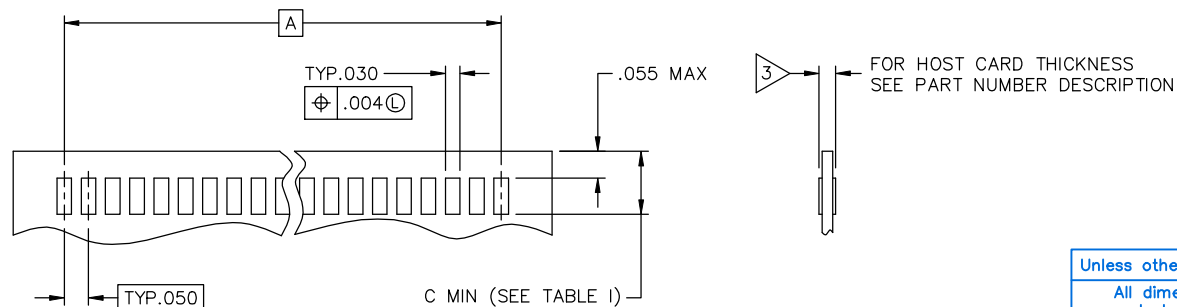
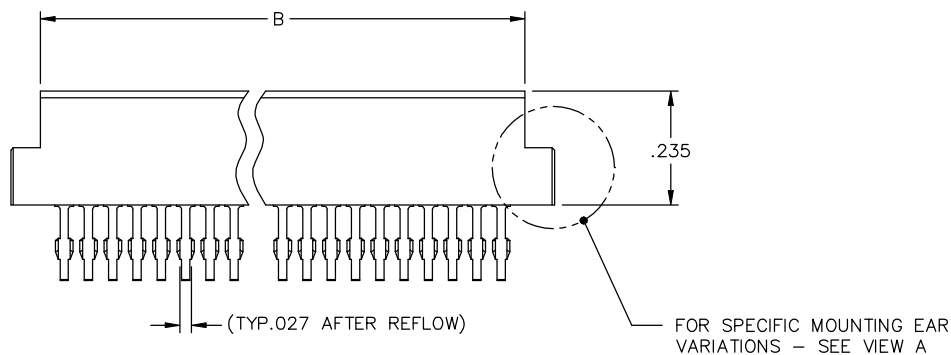
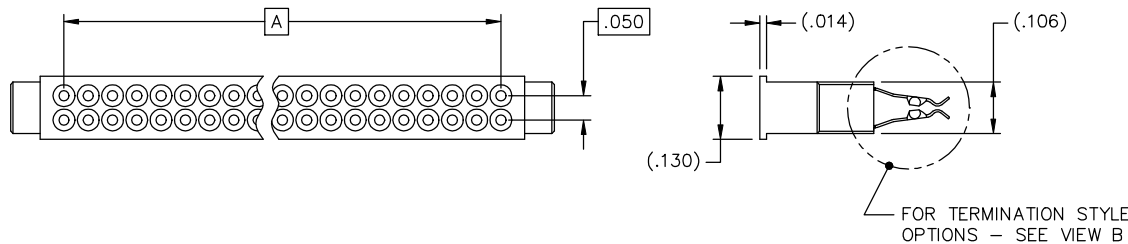

RECOMMENDED HOST CARD LAYOUT

MATERIALS:

HOUSING: HIGH TEMPERATURE THERMOPLASTIC,
UL RATED 94-V0 (LCP)
CONTACT: BERYLLIUM COPPER ALLOY
SOLDER: TIN-LEAD (63-37) WITH NO-CLEAN FLUX

CONTACT FINISH:

INTERFACE AREA: 30 MICROINCHES MIN GOLD
SOLDER TAIL AREA: 100 MICROINCHES MIN TIN-LEAD
GROUND INTERFACE AREA: 50 MICROINCHES MIN NICKEL
UNDERPLATE: 50 MICROINCHES MIN NICKEL

PERFORMANCE CHARACTERISTICS - MECHANICAL

INSERTION FORCE: 68 POSITION - 3.99 KG MAX (TOTAL)
50 POSITION - 2.93 KG MAX (TOTAL)
WITHDRAWAL FORCE: 10 GRAMS MIN (PER CONTACT)
DURABILITY: 10,000 CYCLES MINIMUM
OPERATING TEMP: -55°C - 105°C

PERFORMANCE CHARACTERISTICS - ELECTRICAL

CONTACT RESISTANCE: 20 MILLIOHMS MAX (INITIAL)
30 MILLIOHMS MAX (EOL)
CURRENT CAPACITY: 0.5 AMPS MAX PER CONTACT
DIELECTRIC STRENGTH: 500 VAC RMS MIN
INSULATION RESISTANCE: 1,000 MEGAOHMS MIN

Unless otherwise specified: All dimensions are: Inches [mm]	Drawn by:	Date:	 AN INTERPLEX INDUSTRIES CO. 100 PIONEER AVE WARWICK, RI 02888 TEL: (401) 785-4110 FAX: (401) 781-5730 E-MAIL: sales@teka.com
	R BROWN	12/06/99	
-Tolerances-	Checked by: JSC	Date: 01/12/00	Part No: TSB-____4D-00_ (SEE TABLE)
No of places IN [mm]	Title: PCMCIA & CF SBL RECEPTACLE		
one ±.1 ±2,54	Ref No: S99017		Scale: 4:1
two ±.02 ±0,5			Sheet 1 of 3
three ±.005 ±0,13			
Angular ±1°			

Rev	Description	Date	By
J	ALL REVISIONS - SEE SHEET 1	03/20/01	VAR

PART NO.	A	B	C MIN		
TSB-PCM014D-000	1.560	1.748	.118		
TSB-PCM114D-000					
TSB-PCM114D-001					
TSB-PCM124D-000			.125		
TSB-PCM124D-001					
TSB-PCM034D-000					
TSB-PCM034D-009			1.200	1.412	.118
TSB-PCM134D-000					
TSB-PCM134D-001					
TSB-PCM134D-009					.125
TSB-PCM144D-000					
TSB-PCM144D-001					
TSB-PCM214D-000	1.200	1.412			.118
TSB-PCM214D-001					
TSB-PCM214D-004					
TSB-PCM224D-001					.125
TSB-PCM224D-000					
TSB-PCM234D-001					
TSB-PCM234D-000			1.200	1.412	.118
TSB-PCM234D-009					
TSB-PCM244D-001					
TSB-PCM244D-000					.125
TSB-PCM244D-002					
TSB-PCM314D-000					
TSB-PCM314D-001	1.200	1.412			.118
TSB-PCM324D-000					
TSB-PCM324D-001					
TSB-PCM334D-000					.125
TSB-PCM334D-001					
TSB-PCM344D-000					
TSB-PCM344D-001			1.200	1.412	.118
TSB-COM034D-009					
TSB-COM134D-000					
TSB-COM234D-000					.125
TSB-COM244D-001					
TSB-COM244D-002					
TSB-COM214D-000	1.200	1.412			.118
TSB-COM214D-004					
TSB-COM314D-000					
TSB-COM324D-000					.125
TSB-COM324D-001					
TSB-COM334D-000					
TSB-COM334D-001			1.200	1.412	.118
TSB-COM344D-001					
TSB-COM344D-000					
TSB-COM344D-001					.125
TSB-COM344D-000					
TSB-COM344D-001					

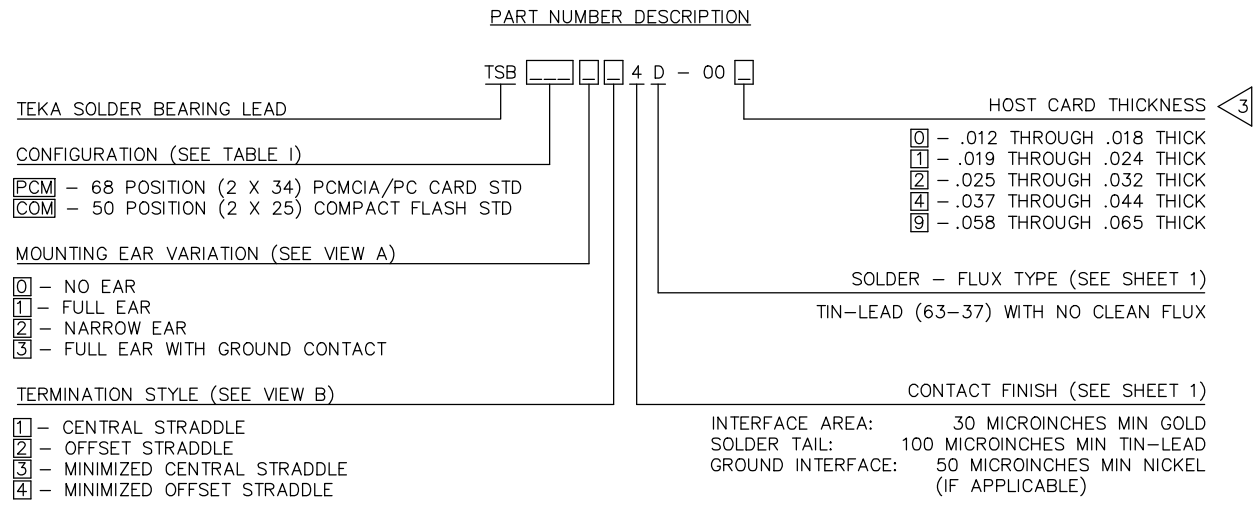

- NOTES: UNLESS OTHERWISE SPECIFIED
- 1 INTERPRET THIS DRAWING IN ACCORDANCE WITH ASME Y14.5M-1994
 - 2 PRODUCTS SHOWN ON THIS DRAWING CONFORM TO ALL APPLICABLE PCMCIA AND CFA SPECIFICATIONS
 - 3 INDICATED HOST CARD THICKNESS FOR REFERENCE ONLY
 - 4 FOR OTHER SIZES, FINISHES OR ADDITIONAL DATA CONTACT TEKA'S CUSTOMER SERVICE DEPARTMENT

Drawn by: R BROWN	Date: 12/06/99	 AN INTERPLEX INDUSTRIES CO. 100 PIONEER AVE WARWICK, RI 02888 TEL: (401) 785-4110 FAX: (401) 781-5730 E-MAIL: sales@teka.com
Checked by: JSC	Date: 01/12/00	
Title: PCMCIA AND CF SBL RECEPTACLE		Part No: TSB-____4D-00_ (SEE TABLE)
Ref No: S99017	Scale: ---	Sheet 2 of 3



TSB-____ [0] _ 4 D-00 _ (NO EAR)

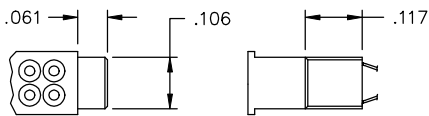

TSB-____ [1] _ 4 D-00 _ (FULL EAR)

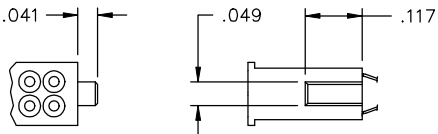

TSB-____ [2] _ 4 D-00 _ (NARROW EAR)

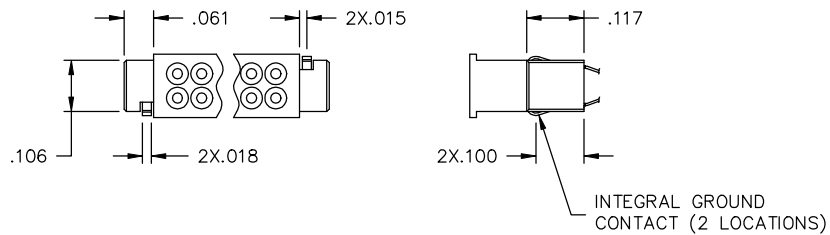

TSB-____ [3] _ 4 D-00 _
(FULL EARS W/ INTEGRAL GROUND CONTACTS)

VIEW A - MOUNTING EAR VARIATIONS

Rev	Description	Date	By
J	ALL REVISIONS - SEE SHEET 1	03/20/01	VAR

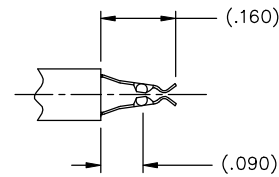

TSB-____ [1] 4 D-00 _
(CENTRAL STRADDLE)

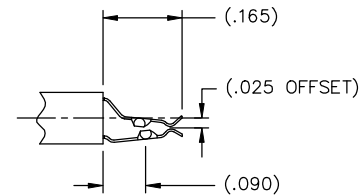

TSB-____ [2] 4 D-00 _
(OFFSET STRADDLE)

VIEW B - TERMINATION STYLE OPTIONS

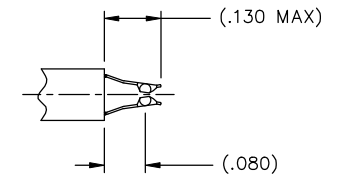

TSB-____ [3] 4 D-00 _
(MINIMIZED CENTRAL STRADDLE)

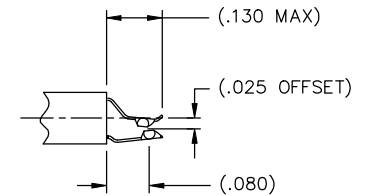

TSB-____ [4] 4 D-00 _
(MINIMIZED OFFSET STRADDLE)

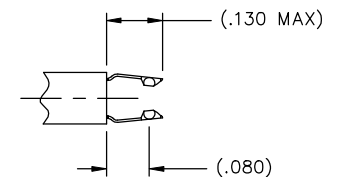

TSB-____ [3] 4 D-00 9
(MINIMIZED CENTRAL STRADDLE - .062 PC CARD ONLY)

Drawn by: R BROWN	Date: 12/06/99	 AN INTERPLEX INDUSTRIES CO. HTTP://WWW.TEKAS.COM	100 PIONEER AVE WARWICK, R.I. 02888 TEL:(401) 785-4110 FAX:(401) 781-5730 E-MAIL: sales@tekas.com
Checked by: JSC	Date: 01/12/00		Title: PCMCIA AND CF SBL RECEPTACLE
Ref No: S99017		Scale: 4:1	Sheet 3 of 3