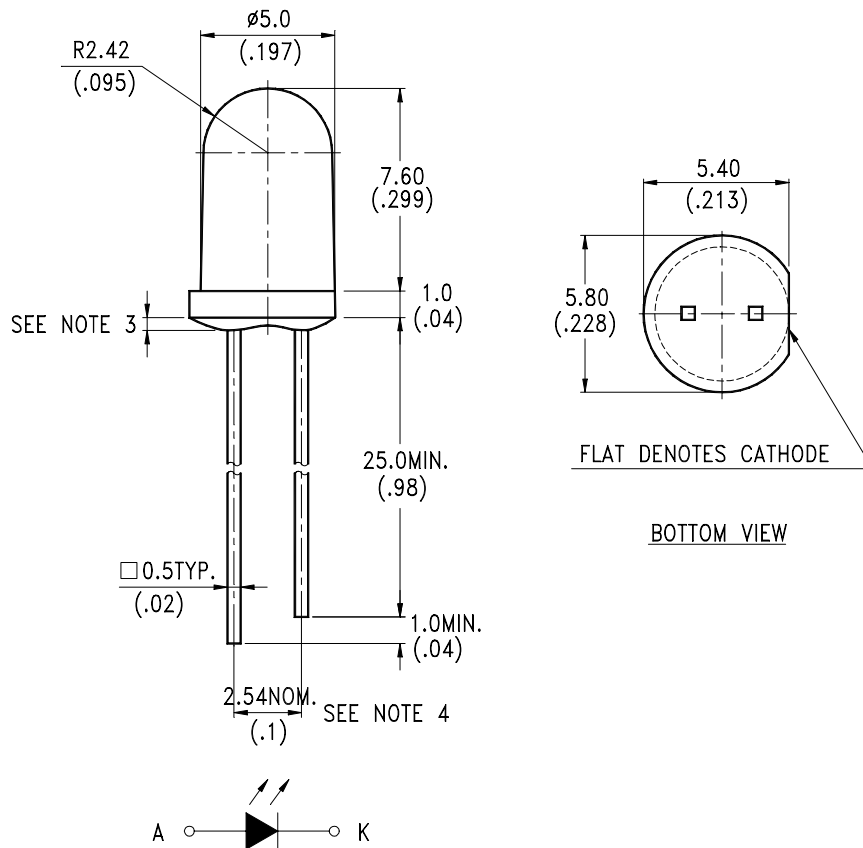

FEATURES

- * HIGH SPEED
- * HIGH POWER
- * AVAILABLE FOR PULSE OPERATING
- * CLEAR TRANSPARENT COLOR PACKAGE

PACKAGE DIMENSIONS**NOTES:**

1. All dimensions are in millimeters (inches).
2. Tolerance is $\pm 0.25\text{mm}$ (.010") unless otherwise noted.
3. Protruded resin under flange is 1.5mm (.059") max.
4. Lead spacing is measured where the leads emerge from the package.
5. Specifications are subject to change without notice.

ABSOLUTE MAXIMUM RATINGS AT TA=25°C

PARAMETER	MAXIMUM RATING	UNIT
Power Dissipation	260	mW
Peak Forward Current (300pps, 10 μ s pulse)	1	A
Continuous Forward Current	100	mA
Reverse Voltage	5	V
Operating Temperature Range	0°C to + 70°C	
Storage Temperature Range	-20°C to + 85°C	
Lead Soldering Temperature [1.6mm(.063") From Body]	260°C for 5 Seconds	

ELECTRICAL / OPTICAL CHARACTERISTICS AT TA=25°C

PARAMETER	SYMBOL	MIN.	TYP.	MAX.	UNIT	TEST CONDITION	BIN NO.
Aperture Radiant Incidence	Ee	1.28		2.64	mW/cm ²	I _F = 20mA	BIN D
		1.76					BIN E
Radiant Intensity	I _E	9.62		19.85	mW/sr	I _F = 20mA	BIN D
		13.23					BIN E
Peak Emission Wavelength	λ_p	860	875	895	nm	I _F = 50mA	
Spectral Line Half-Width	$\Delta \lambda$		50		nm	I _F = 50mA	
Forward Voltage	V _F	1.3	1.5	1.7	V	I _F = 50mA	
Forward Voltage	V _F	1.4	1.67	1.85	V	I _F = 100mA	
Reverse Current	I _R			100	μ A	V _R = 5V	
Rise/Fall Time	Tr/Tf		40		nS	10% ~ 90%	
Viewing Angle (See FIG.6)	2 $\theta_{1/2}$		30		deg.	I _F = 20mA	

TYPICAL ELECTRICAL / OPTICAL CHARACTERISTICS CURVES

(25°C Ambient Temperature Unless Otherwise Noted)

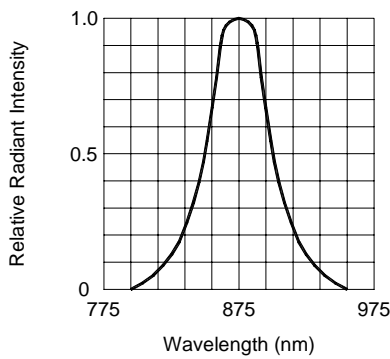

FIG.1 SPECTRAL DISTRIBUTION

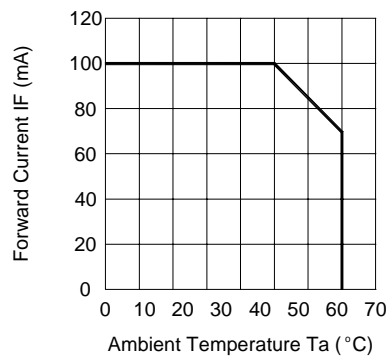

FIG.2 FORWARD CURRENT VS. AMBIENT TEMPERATURE

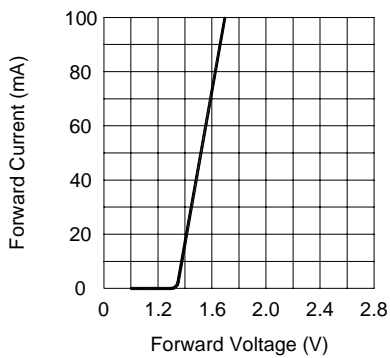

FIG.3 FORWARD CURRENT VS. FORWARD VOLTAGE

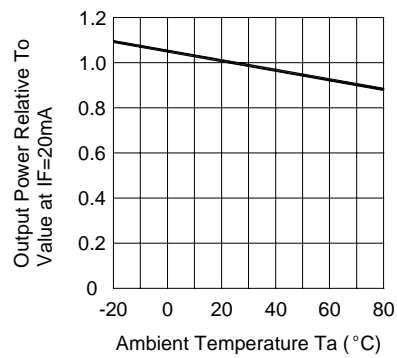

FIG.4 RELATIVE RADIANT INTENSITY VS. AMBIENT TEMPERATURE

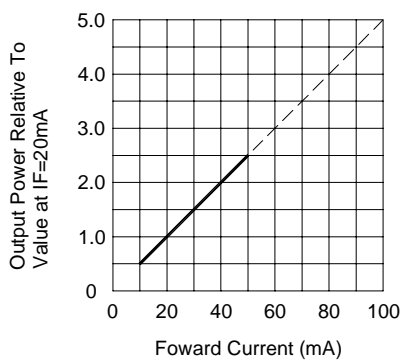

FIG.5 RELATIVE RADIANT INTENSITY VS. FORWARD CURRENT

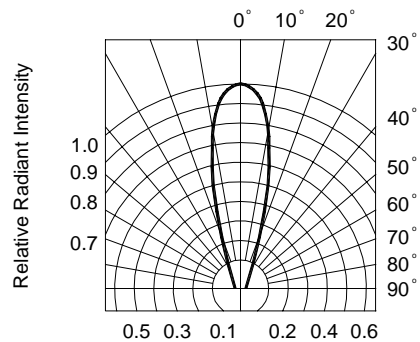

FIG.6 RADIATION DIAGRAM