



DESCRIPTION

Glass passivated thyristors in a plastic envelope, intended for use in applications requiring high bidirectional blocking voltage capability and high thermal cycling performance. Typical applications include motor control, industrial and domestic lighting, heating and static switching.

ABSOLUTE MAXIMUM RATINGS (Ta = 25 °C)

Parameter	Symbol	Typ	Unit
Repetitive peak off-state voltages	V_{DRM} V_{RRM}	600	V
Average on-state current	$I_{T(AV)}$	8.0	A
RMS on-state current	$I_{T(RMS)}$	12	A
Non-repetitive peak on-state current	I_{TSM}	140	A
Max. Operating Junction Temperature	T_j	110	°C
Storage Temperature	T_{stg}	-45~150	°C

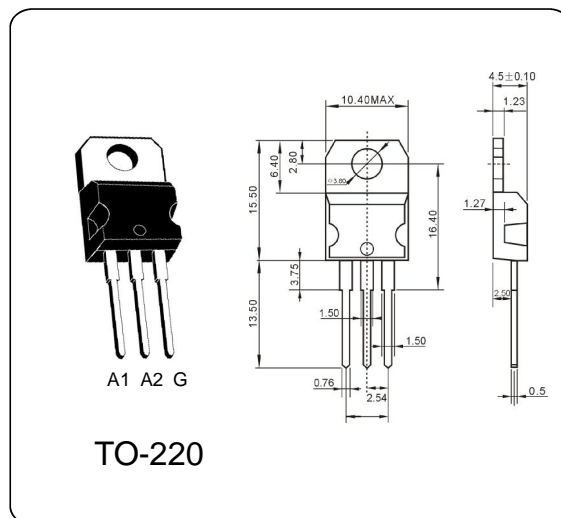

ELECTRICAL CHARACTERISTICS (Ta = 25 °C)

Parameter	Symbol	Test Conditions	Min	Typ	Max	Unit
Repetitive peak off-state voltages	V_{DRM} V_{RRM}		600			V
Average on-state current	$I_{T(AV)}$	half sine wave; $T_{mb} < 103\text{ °C}$		8.0		A
RMS on-state current	$I_{T(RMS)}$	all conduction angles		12		A
On-state voltage	V_{TM}	$I_{TM}=24A, t_p=380\text{ s}$		1.3	1.60	V
Holding current	I_H	$V_D = 12\text{ V}; I_{GT} = 0.1\text{ A}$		7.5	30	mA
Latching current	I_L	$V_D = 12\text{ V}; I_{GT} = 0.1\text{ A}$		10	45	mA
Gate trigger current	I_{GT}	$V_D = 12\text{ V}; I_T = 0.1\text{ A}$		4	15	mA
Gate trigger voltage	V_{GT}	$V_D = 12\text{ V}; I_T = 0.1\text{ A}$		0.6	1.5	V