

Type Key

Type Key

Nominal input voltage in volt	24, 48
Series	IMP, IXP
Nominal output power in watt	3
Nominal output voltage for output 1 in volt	05...15
Nominal output voltage for output 2 in volt	05...15
Operating ambient temperature range T_A -25...71 °C	-7
Option: Industry standard pinout	S

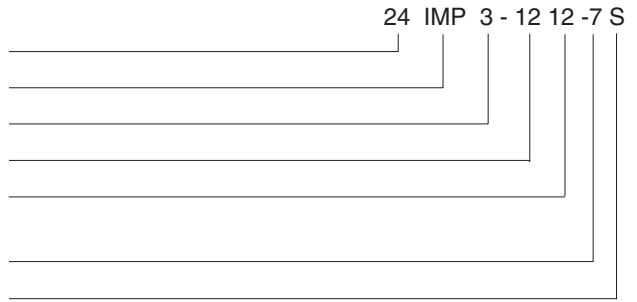

Functional Description

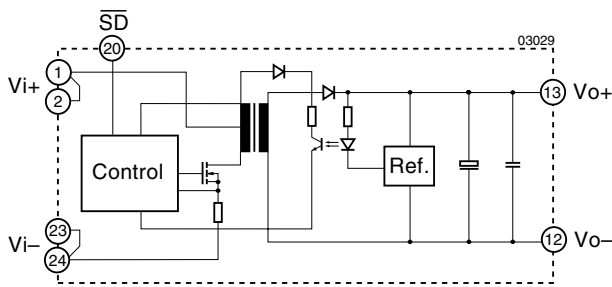

Fig. 1
Single output converter block diagram with alternative pinout

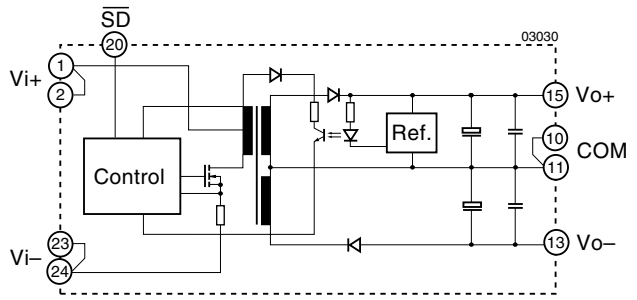

Fig. 2
Dual output converter block diagram with alternative pinout

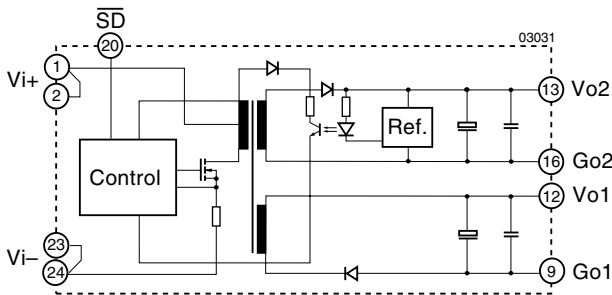

Fig. 3
Double output converter block diagram

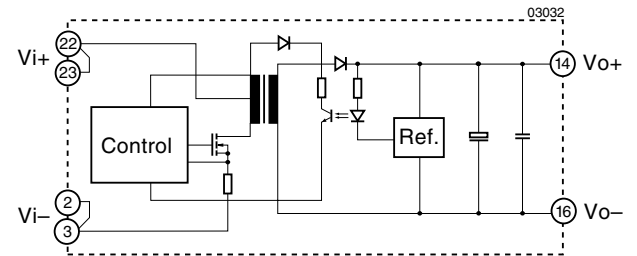

Fig. 4
Single output converter block diagram with industry standard pinout (option S)

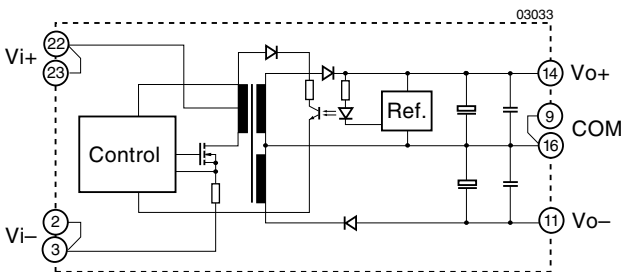

Fig. 5
Dual output converter block diagram with industry standard pinout (option S)

Electrical Input Data

General condition: $T_A = 25^\circ\text{C}$ unless otherwise specified

Table 2: Input data

Input			24 IMP/IXP 3			48 IMP/IXP 3			Unit
Characteristics	Conditions		min	typ	max	min	typ	max	
U_i	Operating input voltage	$T_A \text{ min...} T_A \text{ max}, I_o = 0...I_{o \text{ nom}}$	9		36	18		72	V DC
$U_{i \text{ nom}}$	Nominal input voltage			24			48		
$U_{i \text{ abs}}$	Input voltage without damage		0		40	0		75	
I_{i0}	No load input current	$U_{i \text{ nom}}, I_o = 0$		12			8		mA
I_{iL}	Input current limitation response	$U_{i \text{ nom}}, \text{full load}$		1.25 $P_{i \text{ nom}}$			1.25 $P_{i \text{ nom}}$		W
$U_{i \text{ rev}}$	Reverse input voltage protection	$U_i = \text{negative or reverse polarity}$	shunt diode use external fuse			shunt diode use external fuse			
U_{SD}	Shut down voltage	operating	open or 8...10			open or 8...10			V DC
		not operating	-0.3...2			-0.3...2			
I_{SD}	Shut down current	operating	1...5			1...5			μA
		not operating	-25...-45			-25...-45			

Electrical Output Data

General condition: $T_A = 25^\circ\text{C}$ unless otherwise specified

Table 3a: Output data for single output types

Output			.. IMP/IXP 3-05			.. IMP/IXP 3-12			.. IMP/IXP 3-15			Unit
Characteristics	Conditions		min	typ	max	min	typ	max	min	typ	max	
U_o	Output voltage	$U_{i \text{ nom}}, I_{o \text{ nom}}$	4.90	5	5.10	11.76	12	12.24	14.70	15	15.30	V
$I_{o \text{ nom}}$	Nominal output current: 24 IMP 3 48 IMP 3	$U_i = 9...11 \text{ V DC}$ $U_i = 18...21 \text{ V DC}$		500			250			200		mA
				400			200			150		
				400			200			150		
u_o	Output voltage noise (BW = 20 MHz)	$U_{i \text{ nom}}$ (0.2...1) $I_{o \text{ nom}}$			100			100			100	mV _{pp}
ΔU_{oU}	Static line regulation	$U_{i \text{ min...} U_{i \text{ max}}, I_{o \text{ nom}}$			± 1			± 1			± 1	%
ΔU_{oI}	Static load regulation	$U_{i \text{ nom}}, (0...1) I_{o \text{ nom}}$			± 2			± 2			± 2	
α_{Uo}	Temperature coefficient	$U_{i \text{ nom}}, I_{o \text{ nom}}$			± 0.02			± 0.02			± 0.02	%/K
f_s	Switching frequency		50			50			50			kHz

Table 3b: Output data for dual output types

Output			.. IMP/IXP 3-0505			.. IMP/IXP 3-1212			.. IMP/IXP 3-1515			Unit
Characteristics	Conditions		min	typ	max	min	typ	max	min	typ	max	
U_o	Output voltage	$U_{i \text{ nom}}, I_{o \text{ nom}}$	± 4.90	± 5	± 5.10	± 11.76	± 12	± 12.24	± 14.70	± 15	± 15.30	V
$I_{o \text{ nom}}$	Nominal output current: 24 IMP 3 48 IMP 3	$U_i = 9...11 \text{ V DC}$ $U_i = 18...21 \text{ V DC}$		± 250			± 125			± 100		mA
				± 200			± 100			± 80		
				± 200			± 100			± 80		
u_o	Output voltage noise ¹ (BW = 20 MHz)	$U_{i \text{ min...} U_{i \text{ max}}}$ (0.2...1) $I_{o \text{ nom}}$		150	300		150	300		150	300	mV _{pp}
ΔU_{oU}	Static line regulation	$U_{i \text{ min...} U_{i \text{ max}}, I_{o \text{ nom}}$			± 1			± 1			± 1	%
ΔU_{oI}	Static load regulation	$U_{i \text{ nom}}$ (0.2...1) $I_{o \text{ nom}}$			± 3			± 3			± 3	
α_{Uo}	Temperature coefficient	$U_{i \text{ nom}}, I_{o \text{ nom}}$			± 0.02			± 0.02			± 0.02	%/K
f_s	Switching frequency		50			50			50			kHz

¹ Output voltage noise with option S (standard pin-out) = 300 mV_{pp}

Table 3c: Output data for double output types

Output			.. IMP/IXP 3-05-05			.. IMP/IXP 3-12-12			.. IMP/IXP 3-15-15			
Characteristics		Conditions	min	typ	max	min	typ	max	min	typ	max	Unit
$U_{o\ nom}$	Output voltage	$U_{i\ nom}, I_{o\ nom}$	2 × 5			2 × 12			2 × 15			V
U_o			2 × 4.90	2 × 5.10		2 × 11.76	2 × 12.24		2 × 14.70	2 × 15.30		
$I_{o\ nom}$	Nominal output current: 24 IMP 3 48 IMP 3	$U_i = 9...11\ V\ DC$ $U_i = 18...21\ V\ DC$	2 × 250	2 × 200	2 × 200	2 × 125	2 × 100	2 × 100	2 × 100	2 × 80	2 × 80	mA
u_o	Output voltage noise (BW = 20 MHz)	$U_{i\ min}...U_{i\ max}$ (0.2...1) $I_{o\ nom}$	150			150			150			mV _{pp}
$\Delta U_{o\ U}$	Static line regulation	$U_{i\ min}...U_{i\ max}, I_{o\ nom}$	±1			±1			±1			%
$\Delta U_{o\ I}$	Static load regulation	$U_{i\ nom}, (0.2...1) I_{o\ nom}$	±3			±3			±3			
α_{Uo}	Temperature coefficient	$U_{i\ nom}, I_{o\ nom}$	±0.02			±0.02			±0.02			%/K
f_s	Switching frequency		50			50			50			kHz

Thermal Considerations

If a converter is operated, the relationship between the ambient temperature T_A and the case temperature T_C depends heavily on the conditions of operation and integration into a system. The thermal conditions are influenced by input voltage, output current, airflow, temperature of surrounding components and surfaces and the properties of the printed circuit board. The specified maximum ambient temperature $T_{A\ max}$ is therefore only an indicative value and under practical operating conditions, the ambient temperature T_A may be higher or lower than this value.

Caution: The case temperature T_C measured at the Measuring point of case temperature T_C (see: *Mechanical Data*) may under no circumstances exceed the specified maximum value. The installer must ensure that under all operating conditions T_C remains within the limits stated in the table: *Temperature specifications*.

Connection in Series

The outputs of one or more units can be connected in series. No suppressor diodes are required. Power-One however recommends to protect each individual output with a Zener diode or preferably a suppressor diode, to avoid reverse polarity that may occur if the output voltages do not rise simultaneously.

Auxiliary Function

SD-input

The output voltage is turned on if the pin 20 is open or a voltage of 8...10 V DC is applied. If the voltage at pin 20 is between -0.3 and 2 V DC, the output voltage is turned off.

Connection in Parallel

The outputs of several units can be connected in parallel. However, the use of a single unit with a higher power rating is a better choice because of uneven power distribution among the outputs connected in parallel. It is recommended to select converters to be connected in parallel with very small output voltage differences at full load (i.e. $\leq \pm 0.5\%$). A decoupling diode is not required but recommended.

Protection Scheme

The IMP series is continuously short circuit protected by means of input power limitation. The unit will not be damaged if started up into a short circuit. After removal of the short circuit, it will resume normal operation.

The IMP series is also no-load proof, meaning that the regulation is still effective with no load and the output voltage does not rise. However, due to component tolerances, oscillation could occur and ripple and noise can be outside of specified values. If the converter is used in sensitive electronic circuits with no-load conditions, it is recommended to pre-load the outputs with at least 20% of the specified nominal load.

The maximum voltage without damage is limited to 20 V and the maximum allowed current is limited to 3 mA.

Electromagnetic Compatibility (EMC)

Filter recommendations for compliance with CISPR 22/EN 55022, class B

Electromagnetic emission requirements according to EN 55022, class B can be easily achieved by adding an external input filter consisting of three additional capacitors and one common mode ring core choke.

The filter components should be placed as close as possible to the input of the converter.

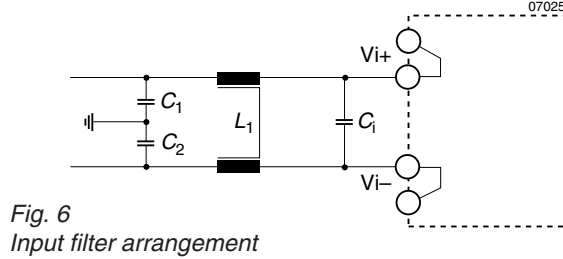

Table 4: Input filter components

Input voltage	C ₁	C ₂	Type	L ₁	Type	C ₃	Type
24, 48 V DC	2.2 μF ¹ 100 V	2.2 μF ¹ 100 V	Siemens B 32522 C1225-K	2.2 mH	Siemens B 82722 A2202-N1	4.7 μF 100 V	Al-Chip (low ESR)

¹ Only valid for input voltages up to 60 V DC.

Immunity to Environmental Conditions

Thermal Considerations

Table 5: Temperature specifications, valid for air pressure of 800...1200 hPa (800...1200 mbar)

Temperature			Standard -7		Unit
Characteristics	Conditions	min	max		
T _A	Ambient temperature	U _{i nom.}	-25	71	°C
T _C	Case temperature	I _o = 0 ... I _{o nom.}	-25	90	
T _S	Storage temperature	Non operational	-40	100	

Table 6: MTBF

Values at specified case temperature	Ground Benign	Ground Fixed		Ground Mobile
	40°C	40°C	70°C	50°C
MTBF according to MIL-HDBK-217F, N2	3'759'000 h	715'000 h	275'000 h	289'000 h

Mechanical Data

Dimensions in mm. Tolerances ±0.3 mm unless otherwise specified.

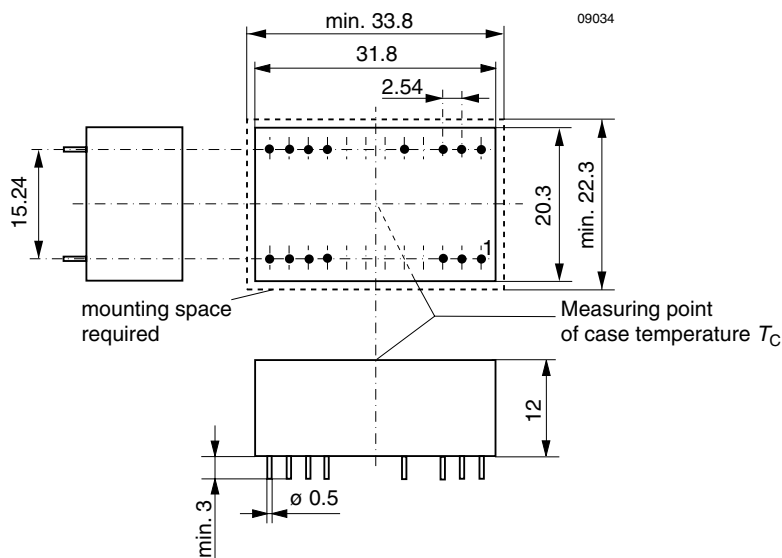

Fig. 7
Case: DIL 24
Weight: 16 g

Safety and Installation Instructions

Installation Instruction

Installation of the DC-DC converters must strictly follow the national safety regulations in compliance with the enclosure, mounting, creepage, clearance, casualty, markings and segregation requirements of the end-use application.

Connection to the system shall be made via a printed circuit board according to: *Mechanical Data*.

The units should be connected to a secondary circuit.

Check for hazardous voltages before altering any connections.

Ensure that a unit failure (e.g. by an internal short-circuit) does not result in a hazardous condition. See also *Safety of operator accessible output circuit*.

Input Fuse

To prevent excessive current flowing through the input supply line in case of a short-circuit across the converter input an external fuse should be installed in a non earthed input supply line. We recommend a fast acting fuse F1A for 24 IMP 3 and 24 IXP 3 types and F0.5A for 48 IMP 3 and 48 IXP 3 types..

Cleaning Agents

In order to avoid possible damage, any penetration of cleaning fluids is to be prevented, since the power supplies are not hermetically sealed.

Standards and approvals

The units have been evaluated for:

- Building in
- Operational insulation input to output
- The use in a pollution degree 2 environment
- Connecting the input to a secondary circuit which is subject to a maximum transient rating of 1500 V (IMP 3) or 4000 V (IXP 3).

Protection Degree

The protection degree of the DC-DC converters is IP 40.

Isolation

The electric strength test is performed as factory test in accordance with IEC/EN 60950 and UL 1950 and should not be repeated in the field. Power-One will not honour any guarantee claims resulting from electric strength field tests.

Table 7: Electric strength test voltages, clearance and creepage distances

Characteristic	Input to output		Output to output	Unit
	IMP 3	IXP 3		
Electric strength test voltage 1 s	1.1	2.5	0.35	kV _{rms}
	1.5	3.5	0.5	kV DC
Coupling capacitance	≈40	≈40	≈30	pF
Insulation resistance at 500 V DC	>1000	>1000	>100	M Ω

Table 8: Pin allocation alternative pinout

Pin	Single output	Dual output	Double output
1	Vi+	Vi+	Vi+
2	Vi+	Vi+	Vi+
9	–	–	Go1
10	–	COM	–
11	–	COM	–
12	Vo–	–	Vo1
13	Vo+	Vo–	Vo2
15	–	Vo+	–
16	–	–	Go2
20	SD	SD	SD
23	Vi–	Vi–	Vi–
24	Vi–	Vi–	Vi–

Table 9: Pin allocation industry standard pinout (option S)

Pin	Single output	Dual output
2	Vi–	Vi–
3	Vi–	Vi–
9	n.c.	COM
10	–	–
11	n.c.	Vo–
14	Vo+	Vo+
15	–	n.c.
16	Vo–	COM
22	Vi+	Vi+
23	Vi+	Vi+

Safety of operator accessible output circuit

If the output circuit of a DC-DC converter is operator accessible, it shall be an SELV circuit according to IEC/EN 60950 related safety standards

The following table shows some possible installation configurations, compliance with which causes the output circuit of the DC-DC converter to be an SELV circuit according to

IEC/EN 60950 up to a configured output voltage (sum of nominal voltages if in series or +/- configuration) of 30 V.

However, it is the sole responsibility of the installer to assure the compliance with the relevant and applicable safety regulations. More information is given in: *Technical Information: Safety*.

Table 10: Insulation concept leading to an SELV output circuit

Conditions	Front end			DC-DC converter	Result
Supply voltage	Minimum required grade of isolation, to be provided by the AC-DC front end, including mains supplied battery charger	Maximum DC output voltage from the front end ¹	Minimum required safety status of the front end output circuit	Measures to achieve the specified safety status of the output circuit	Safety status of the DC-DC converter output circuit
Mains ≤250 V AC	Basic	≤60 V	Earthed SELV circuit ²	Operational insulation, provided by the DC-DC converter	SELV circuit
			ELV circuit	Input fuse ³ output suppressor diodes ⁴ , and earthed output circuit ²	Earthed SELV circuit
		>60 V	Hazardous voltage secondary circuit		
	Double or reinforced	≤60 V	SELV circuit	Operational insulation, provided by the DC-DC converter	SELV circuit
			>60 V	TNV-2 circuit	Earthed output circuit ²
		>60 V	TNV-3 circuit (only with IXP units)		
		>60 V	Double or reinforced insulated unearthed hazardous voltage secondary circuit ⁵	Input fuse ³ and output suppressor diodes ⁴	SELV circuit

¹ The front end output voltage should match the specified input voltage range of the DC-DC converter.

² The earth connection has to be provided by the installer according to the relevant safety standard, e.g. IEC/EN 60950.

³ The installer shall provide an approved fuse (type with the lowest rating suitable for the application) in a non-earthed input conductor directly at the input of the DC-DC converter (see fig.: *Schematic safety concept*). For UL's purpose, the fuse needs to be UL-listed. See also: *Input Fuse*.

⁴ Each suppressor diode should be dimensioned in such a way, that in the case of an insulation fault the diode is able to limit the output voltage to SELV (<60 V) until the input fuse blows (see fig.: *Schematic safety concept*).

⁵ Has to be insulated from earth by double or reinforced insulation according to the relevant safety standard, based on the maximum output voltage from the front end.

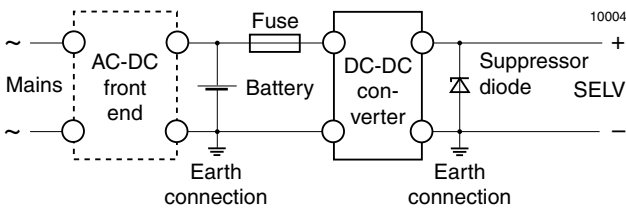

Fig. 8
Schematic safety concept. Use fuse, suppressor diode and earth connection as per table: Safety concept leading to an SELV output circuit.