

SEMICONDUCTOR PROTECTION FUSES

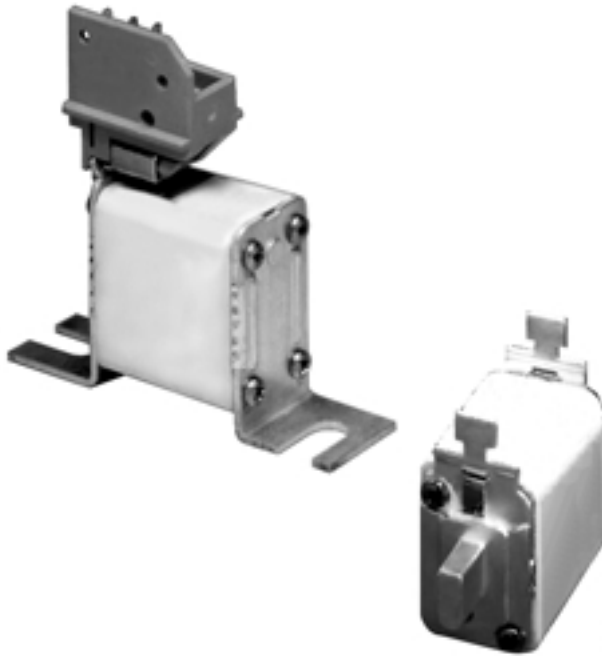

PROTISTOR FUSES

690V

gRB-URB FROM 16 TO 450A

SIZE: 00

Features/Benefits

- **Extremely high Interrupting rating Fuses:**
Protection of power Semiconductors according to IEC 269.1 and 4
- **690V Voltage Rating**
- **gR Class** [gRB Ratings 16 to 160 A] According to VDE 636-23
 - Full range protection
 - Improving safety and protection
 - Allows selective coordination
- **aR Class** [URC and URD Ratings 16 to 450A] According to VDE 636-23 and IEC 269.4
- **Connections According to:**
 - DIN 43653/00C 80 and 110mm Between Axes
 - DIN 43620/00C Solid Blades
- **Optional pin indicator for operating a microswitch**



APPLICATIONS DATA

VOLTAGE RATING U_N (V)	CLASS	CURRENT RATING I_N (A)	PRE-ARCING $I^2t @ 1\text{ ms}$ I^2t_p (A ² s)	TOTAL CLEARING $I^2t @ I_N$ I^2t_t (A ² s)	WATT LOSSES		TESTED INTERRUPTING RATING	ESTIMATED INTERRUPTING RATING				
					0.8 I_N	I_N						
690	gRB	16	8	61	2.7	5	200 kA @ 690 V	300 kA @ 690 V				
		20	12	86	3.3	6						
		25	18	140	4.4	8						
		32	39	250	6.0	11						
		40	68	450	7.1	13						
		50	116	750	8.8	16						
		63	210	1400	9.9	18						
		80	525	3000	10.5	19						
		100	970	5400	10.7	19.5						
		125	1710	9600	13.2	24						
	160	4270	22400	13.7	25							
	690	URB	16	7	52	3.8	7	200 kA @ 690 V	300 kA @ 690 V			
			20	10	75	5.0	9					
			25	15	120	6.0	11					
			32	32	210	8.2	15					
			40	61	400	9.9	18					
			50	102	700	11.5	21					
			63	177	1200	12.6	23					
			80	390	2200	13.8	25					
			100	692	3900	15.4	28					
125			1170	6600	18.1	33						
690	URB	160	2680	14 000	19.8	36	200 kA @ 690 V	300 kA @ 600 V				
		200	2690	24 000	23.1	42						
		250	8300	42 500	27.5	50						
		315	17 520	81 000	31.9	58						
		350•	25 450	118 000	33.0	60						
		400•	33 200	150 000	38.5	70						
		690	URB	450**	51 850	225 000			40.7	74	200 kA @ 690 V	300 kA @ 600 V

Note: voltage rating of 350-400-450 A rated fuses is defined with a CC' curve at 1 second limited by the minimum breaking current.

• Voltage rating: 690V with CC' at 1s - 450V with CC' at 10 s
 **Voltage rating: 600V with CC' at 1s - 450V with CC' at 10 s

DIN FUSES

SIZE 00

SEMICONDUCTOR PROTECTION FUSES

GERMAN STANDARD ACCORDING TO DIN 43653/00C - DIN 80 & 110

**gRB
DIN 80**

CURRENT RATING	CATALOG NO.	REF #	I/IN FUSE-BASE
16	6,9 gRB 00 D08L 016	S330273	1
20	6,9 gRB 00 D08L 020	S330227	1
25	6,9 gRB 00 D08L 025	T330228	1
32	6,9 gRB 00 D08L 032	V330229	1
40	6,9 gRB 00 D08L 040	W330230	1
50	6,9 gRB 00 D08L 050	X330231	1
63	6,9 gRB 00 D08L 063	Y330232	1
80	6,9 gRB 00 D08L 080	Z330233	1
100	6,9 gRB 00 D08L 100	A330234	1
125	6,9 gRB 00 D08L 125	B330235	0.9
160	6,9 gRB 00 D08L 160	C330236	0.9

**URB
DIN 80**

CURRENT RATING	CATALOG NO.	REF #	I/IN FUSE-BASE
16	6,9 URB 00 D08L 016	V330275	1
20	6,9 URB 00 D08L 020	T330274	1
25	6,9 URB 00 D08L 025	M330268	1
32	6,9 URB 00 D08L 032	N330269	1
40	6,9 URB 00 D08L 040	P330270	1
50	6,9 URB 00 D08L 050	Q330271	1
63	6,9 URB 00 D08L 063	R330272	1
80	6,9 URB 00 D08L 080	D330237	1
100	6,9 URB 00 D08L 100	E330238	1
125	6,9 URB 00 D08L 125	F330239	0.9
160	6,9 URB 00 D08L 160	G330240	0.85
200	6,9 URB 00 D08L 200	H330241	0.85
250	6,9 URB 00 D08L 250	J330242	0.80
315	6,9 URB 00 D08L 315	K330243	0.75
350	6,9 URB 00 D08L 350	L330244	0.75
400	6,9 URB 00 D08L 400	M330245	0.70
450	6 URB 00 D08L 450	N330246	0.65

GERMAN STANDARD ACCORDING TO DIN 43653/00C DIN 80 & 110

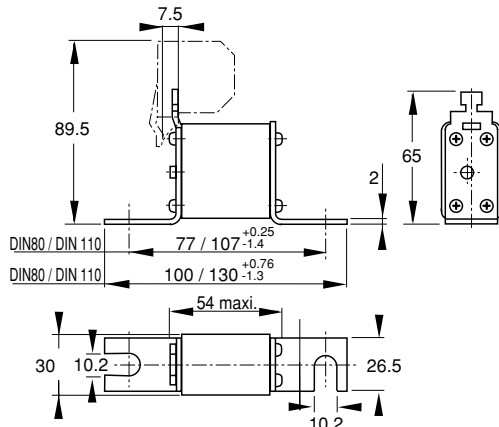

**gRB
DIN 110**

CURRENT RATING	CATALOG NO.	REF #	I/IN FUSE-BASE
16	6,9 gRB 00 D11L 016	W330276	1
20	6,9 gRB 00 D11L 020	P330247	1
25	6,9 gRB 00 D11L 025	Q330248	1
32	6,9 gRB 00 D11L 032	R330249	1
40	6,9 gRB 00 D11L 040	S330250	1
50	6,9 gRB 00 D11L 050	T330251	1
63	6,9 gRB 00 D11L 063	V330252	1
80	6,9 gRB 00 D11L 080	W330253	1
100	6,9 gRB 00 D11L 100	X330254	1
125	6,9 gRB 00 D11L 125	Y330255	0.9
160	6,9 gRB 00 D11L 160	Z330256	0.9

**URB
DIN 110**

CURRENT RATING	CATALOG NO.	REF #	I/IN FUSE-BASE
80	6,9 URB 00 D11L 80	A330257	1
100	6,9 URB 00 D11L 100	B330258	1
125	6,9 URB 00 D11L 125	C330259	0.9
160	6,9 URB 00 D11L 160	D330260	0.85
200	6,9 URB 00 D11L 200	E330261	0.85
250	6,9 URB 00 D11L 250	F330262	0.80
315	6,9 URB 00 D11L 315	G330263	0.75
350	6,9 URB 00 D11L 350	H330264	0.75
400	6,9 URB 00 D11L 400	J330265	0.70
450	6 URB 00 D11L 450	K330266	0.65

Weight : 140 g(D08) - 190 g(D11)
Packaging : 3 pieces

Microswitches:

6.3 clips	MC 4L 2.5 B6 - Part #: L076646 or MC 4L 2.5 B6 + PRES - Part #: F210156
2.8 clips	MC 4L 2.5 B2 - Part #: G076642 or MC 4L 2.5 B2 + PRES - Part #: G210157

Fuse-base: SI 00 DIN 80 (80 and 110) - Part #: Q098040

GERMAN STANDARD ACCORDING TO DIN 43620/00

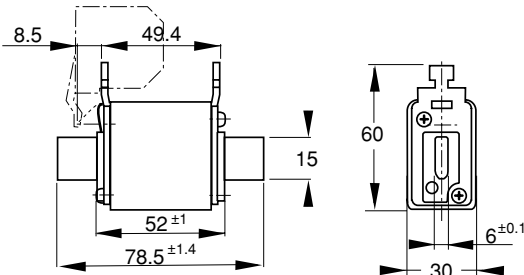

**gRB
DIN 43620**

CURRENT RATING	CATALOG NO.	REF #	I/IN FUSE-BASE
16	6,9 gRB 00 PV/016	L330267	1
20	6,9 gRB 00 PV/020	W330207	1
25	6,9 gRB 00 PV/025	X330208	1
32	6,9 gRB 00 PV/032	Y330209	1
40	6,9 gRB 00 PV/040	Z330210	1
50	6,9 gRB 00 PV/050	A330211	1
63	6,9 gRB 00 PV/063	B330212	0.90
80	6,9 gRB 00 PV/080	C330213	0.90
100	6,9 gRB 00 PV/100	D330214	0.90
125	6,9 gRB 00 PV/125	E330215	0.85
160	6,9 gRB 00 PV/160	F330216	0.85

**URB
DIN 43620**

CURRENT RATING	CATALOG NO.	REF #	I/IN FUSE-BASE
80	6,9 URB 00 PV/080	G330217	0.90
100	6,9 URB 00 PV/100	H330218	0.90
125	6,9 URB 00 PV/125	J330219	0.85
160	6,9 URB 00 PV/160	K330220	0.85
200	6,9 URB 00 PV/200	L330221	0.85
250	6,9 URB 00 PV/250	M330222	0.80
315	6,9 URB 00 PV/315	N330223	0.75
350	6,9 URB 00 PV/350	P330224	0.75
400	6,9 URB 00 PV/400	Q330225	0.70
450	6 URB 00 PV/450	R330226	0.65

Weight : 210 g
Packaging : 3 pieces

Microswitches:

6.3 clips	MC 4L 2.5 B6 - Part #: L076646 or MC 4L 2.5 B6 + PRES - Part #: F210156
2.8 clips	MC 4L 2.5 B2 - Part #: G076642 or MC 4L 2.5 B2 + PRES - Part #: G210157

Fuse-base: 41002-G

I/IN : Ratio RMS steady current / current rating for fuses in base.

ELECTRICAL CHARACTERISTICS

Total Clearing I^2t - gRB

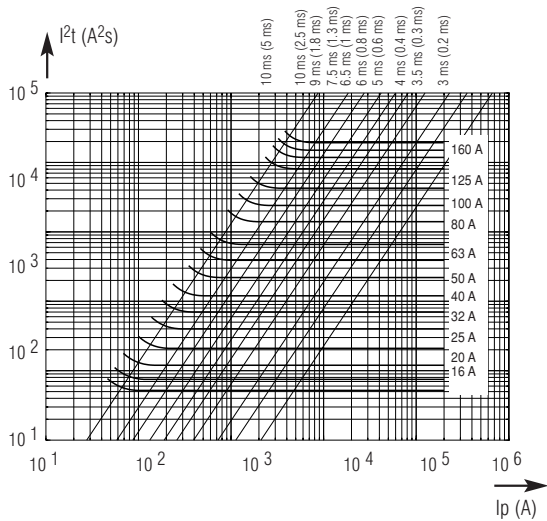

Total Clearing I^2t - URB

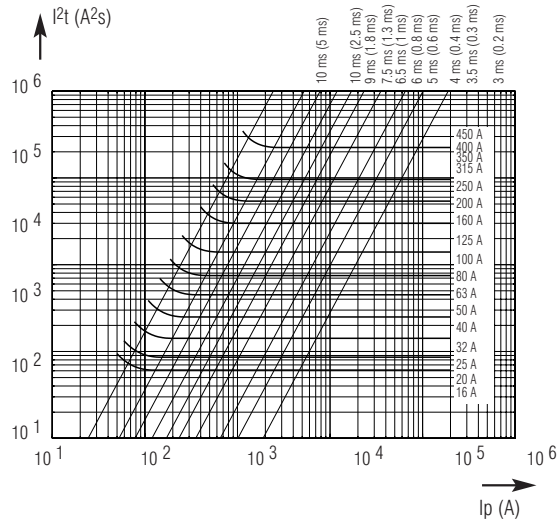

The flat curves show for each rated current the maximum values of total clearing I^2t (I^2t_4) as a function of a prospective current I_p . @ U_{N1} , with $\cos \phi = 0.15$. The crosswise lines indicate the total clearing duration T_t and the associated pre-arcing duration in brackets.



I^2t Correction Factor

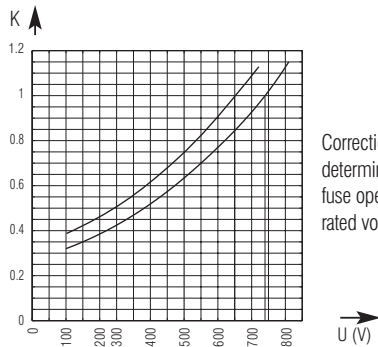

Correction factor to determine I^2t value for a fuse operating below its rated voltage.

Peak Arc Voltage

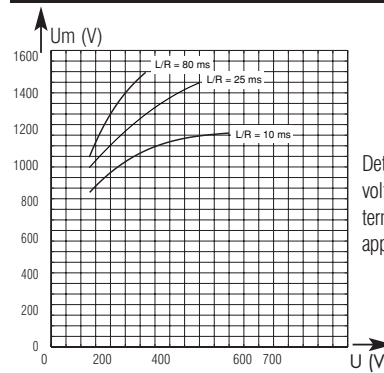

Determines the peak arc voltage across the fuse terminals as a function of applied voltage.

Watt Loss Correction

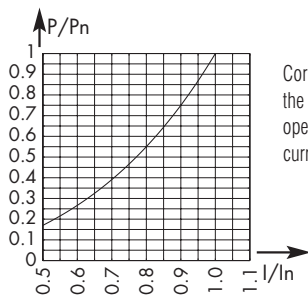

Correction factor to determine the watts loss value for a fuse operating below its rated current.

D.C. Voltage capability vs. Time Constant

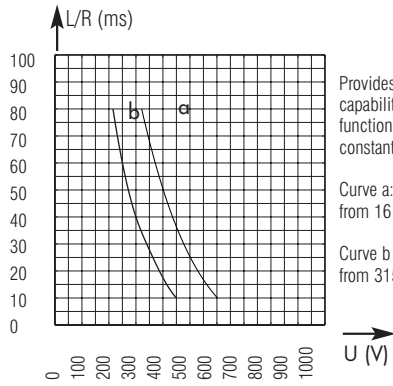

Provides the DC voltage capability of a fuse as a function of circuit time constant (L/R ratio)

Curve a: for ratings from 16 to 250 A

Curve b: for ratings from 315 to 450 A

Rated Current	Curve	I _{pm} (A)	
		gRB	URB
16	a	32	32
20	a	40	40
25	a	50	50
32	a	64	64
40	a	80	80
50	a	100	100
63	a	126	126
80	a	160	170
100	a	200	220
125	a	250	280
160	a	320	390
200	a		510
250	a		650
315	b		840
350	b		1770
400	b		2040
450	b		

The I_{pm} values give the minimum DC interrupting current in amps.

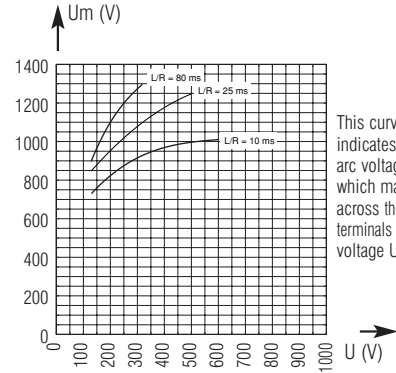

This curve indicates the peak arc voltage, U_m, which may appear across the fuse terminals at working voltage U.

Peak Let-Thru Data - gRB

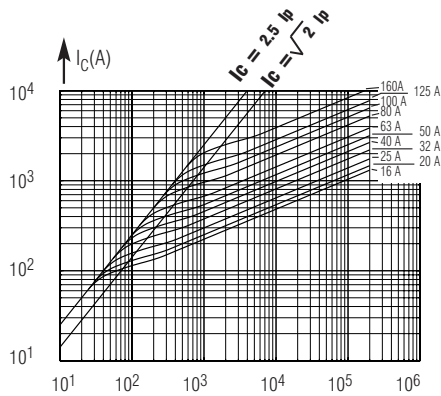

These curves show for each rating the value of the peak let-through current I_c as a function of the available fault current I_p.

Peak Let-Thru Data - URB

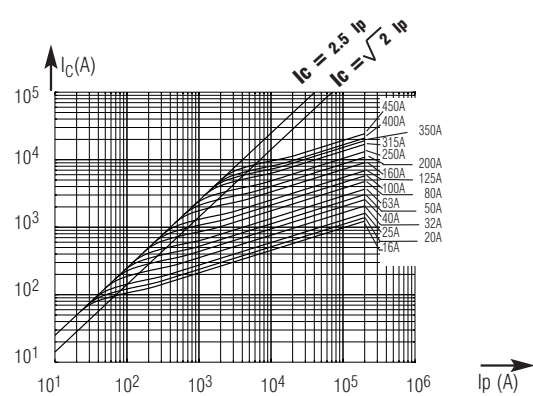

Melting time - Current data - gRB

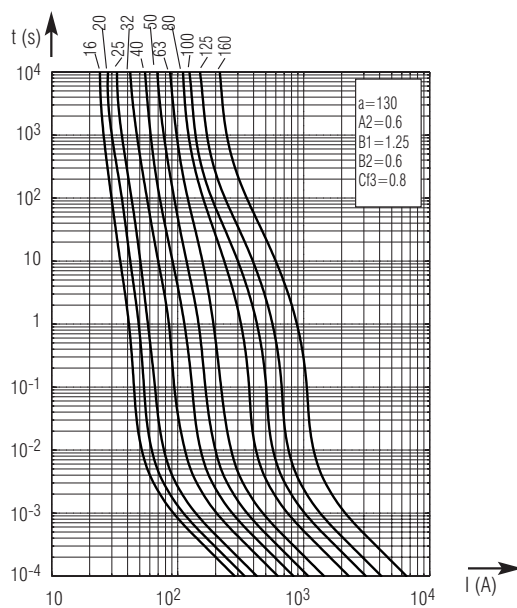

Melting time - Current data - URB

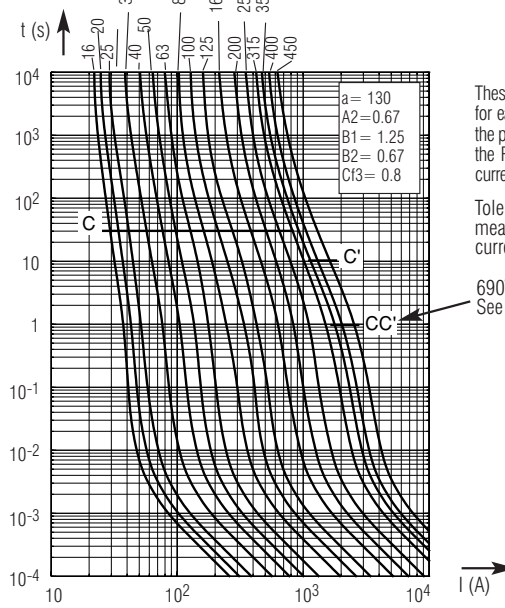

These curves indicate, for each rated current, the pre-arcing time vs. the R.M.S. pre-arcing current

Tolerance for the mean pre-arcing current ± 8%.

690V or 600V See note page D 61