

## Dual Enhancement Mode MOSFET (N- and P-Channel)

### Features

- N-Channel  
40V/7.5A,  
 $R_{DS(ON)} = 30m\Omega$  (typ.) @  $V_{GS} = 10V$   
 $R_{DS(ON)} = 46m\Omega$  (typ.) @  $V_{GS} = 5V$
- P-Channel  
-40V/-6A,  
 $R_{DS(ON)} = 40m\Omega$  (typ.) @  $V_{GS} = -10V$   
 $R_{DS(ON)} = 52m\Omega$  (typ.) @  $V_{GS} = -5V$
- Super High Dense Cell Design
- Reliable and Rugged
- Lead Free and Green Devices Available (RoHS Compliant)

### Pin Description

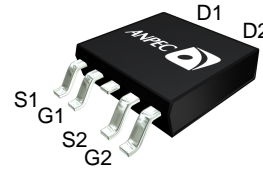

Top View of TO-252-4

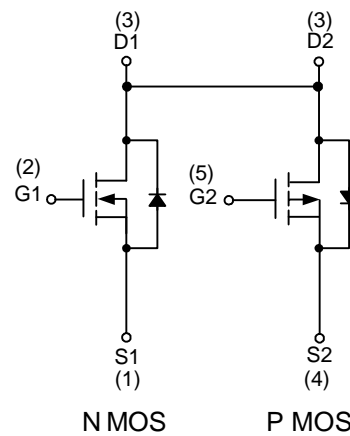

### Applications

- Power Management in LCD monitor/TV

### Ordering and Marking Information

<p>APM4052D <span style="font-family: monospace;">□□□-□□□</span></p> <div style="margin-left: 20px;"> <p>└─ Assembly Material</p> <p>└─ Handling Code</p> <p>└─ Temperature Range</p> <p>└─ Package Code</p> </div>	<p>Package Code U4 : TO-252-4</p> <p>Operating Junction Temperature Range C : -55 to 150 °C</p> <p>Handling Code TR : Tape &amp; Reel</p> <p>Assembly Material G : Halogen and Lead Free Device</p>
<p>APM4052D U4 : <span style="border: 1px solid black; padding: 2px; display: inline-block; text-align: center;">  APM4052D XXXXX         </span></p>	<p>XXXXX - Date Code</p>

Note: ANPEC lead-free products contain molding compounds/die attach materials and 100% matte tin plate termination finish; which are fully compliant with RoHS. ANPEC lead-free products meet or exceed the lead-free requirements of IPC/JEDEC J-STD-020C for MSL classification at lead-free peak reflow temperature. ANPEC defines "Green" to mean lead-free (RoHS compliant) and halogen free (Br or Cl does not exceed 900ppm by weight in homogeneous material and total of Br and Cl does not exceed 1500ppm by weight).

ANPEC reserves the right to make changes to improve reliability or manufacturability without notice, and advise customers to obtain the latest version of relevant information to verify before placing orders.

## Absolute Maximum Ratings (T<sub>A</sub> = 25°C unless otherwise noted)

Symbol	Parameter		Rating		Unit
			N Channel	P Channel	
V <sub>DSS</sub>	Drain-Source Voltage		40	-40	V
V <sub>GSS</sub>	Gate-Source Voltage		±20	±20	
I <sub>D</sub> <sup>a</sup>	Continuous Drain Current	T <sub>C</sub> =25°C	7.5	-6	A
I <sub>DM</sub> <sup>a</sup>	Pulsed Drain Current	T <sub>C</sub> =25°C	30	-25	
I <sub>S</sub> <sup>a</sup>	Diode Continuous Forward Current	T <sub>C</sub> =25°C	7.5	-6	A
T <sub>J</sub>	Maximum Junction Temperature		150		°C
T <sub>STG</sub>	Storage Temperature Range		-55 to 150		
P <sub>D</sub>	Power Dissipation	T <sub>C</sub> =25°C	2.5		W
		T <sub>C</sub> =100°C	1		
R <sub>θJC</sub>	Thermal Resistance-Junction to Case		5		°C/W
R <sub>θJA</sub> <sup>a</sup>	Thermal Resistance-Junction to Ambient		50		

Note : Surface Mounted on 1in<sup>2</sup> pad area, t ≤ 10sec.

## Electrical Characteristics (T<sub>A</sub> = 25°C unless otherwise noted)

Symbol	Parameter	Test Conditions	APM4052DU4			Unit	
			Min.	Typ.	Max.		
<b>Static Characteristics</b>							
BV <sub>DSS</sub>	Drain-Source Breakdown Voltage	V <sub>GS</sub> =0V, I <sub>DS</sub> =250μA	N-Ch	40	-	-	V
		V <sub>GS</sub> =0V, I <sub>DS</sub> =-250μA	P-Ch	-40	-	-	
I <sub>DSS</sub>	Zero Gate Voltage Drain Current	V <sub>DS</sub> =32V, V <sub>GS</sub> =0V T <sub>J</sub> =85°C	N-Ch	-	-	1	μA
			P-Ch	-	-	30	
		V <sub>DS</sub> =-32V, V <sub>GS</sub> =0V T <sub>J</sub> =85°C	N-Ch	-	-	-1	
			P-Ch	-	-	-30	
V <sub>GS(th)</sub>	Gate Threshold Voltage	V <sub>DS</sub> =V <sub>GS</sub> , I <sub>DS</sub> =250μA	N-Ch	1.3	2	2.5	V
		V <sub>DS</sub> =V <sub>GS</sub> , I <sub>DS</sub> =-250μA	P-Ch	-1.3	-2	-2.5	
I <sub>GSS</sub>	Gate Leakage Current	V <sub>GS</sub> =±20V, V <sub>DS</sub> =0V	N-Ch	-	-	±100	nA
		V <sub>GS</sub> =±20V, V <sub>DS</sub> =0V	P-Ch	-	-	±100	
R <sub>DS(ON)</sub> <sup>a</sup>	Drain-Source On-State Resistance	V <sub>GS</sub> =10V, I <sub>DS</sub> =7.5A	N-Ch	-	30	38	mΩ
		V <sub>GS</sub> =-10V, I <sub>DS</sub> =-6A	P-Ch	-	40	50	
		V <sub>GS</sub> =5V, I <sub>DS</sub> =5A	N-Ch	-	46	62	
		V <sub>GS</sub> =-5V, I <sub>DS</sub> =-3.5A	P-Ch	-	52	73	

**Electrical Characteristics (Cont.)** ( $T_A = 25^\circ\text{C}$  unless otherwise noted)

Symbol	Parameter	Test Conditions	APM4052DU4			Unit	
			Min.	Typ.	Max.		
<b>Diode Characteristics</b>							
$V_{SD}^a$	Diode Forward Voltage	$I_{SD}=2A, V_{GS}=0V$	N-Ch	-	0.8	1.1	V
		$I_{SD}=-2A, V_{GS}=0V$	P-Ch	-	-0.8	-1.1	
$t_{rr}$	Reverse Recovery Time	N-Channel $I_{DS}=7.5A, dI_{SD}/dt=100A/\mu s$	N-Ch	-	21	-	ns
			P-Ch	-	17	-	
$Q_{rr}$	Reverse Recovery Charge	P-Channel $I_{DS}=-6A, dI_{SD}/dt=100A/\mu s$	N-Ch	-	16	-	nC
			P-Ch	-	10	-	
<b>Gate Charge Characteristics<sup>b</sup></b>							
$Q_g$	Total Gate Charge	N-Channel $V_{DS}=20V, V_{GS}=10V,$ $I_{DS}=7.5A$	N-Ch	-	10	14	nC
			P-Ch	-	17	24	
$Q_{gs}$	Gate-Source Charge	P-Channel $V_{DS}=-20V, V_{GS}=-10V,$ $I_{DS}=-6A$	N-Ch	-	1.7	-	
			P-Ch	-	2.2	-	
$Q_{gd}$	Gate-Drain Charge		N-Ch	-	3.2	-	
			P-Ch	-	4	-	
<b>Dynamic Characteristics<sup>b</sup></b>							
$R_G$	Gate Resistance	$V_{GS}=0V, V_{DS}=0V, F=1MHz$	N-Ch	-	2.2	-	$\Omega$
			P-Ch	-	8	-	
$C_{iss}$	Input Capacitance	N-Channel $V_{GS}=0V,$ $V_{DS}=20V,$ Frequency=1.0MHz	N-Ch	-	480	-	pF
			P-Ch	-	970	-	
$C_{oss}$	Output Capacitance	P-Channel	N-Ch	-	70	-	
			P-Ch	-	100	-	
$C_{rss}$	Reverse Transfer Capacitance	$V_{GS}=0V,$ $V_{DS}=-20V,$ Frequency=1.0MHz	N-Ch	-	50	-	
			P-Ch	-	70	-	
$t_{d(ON)}$	Turn-on Delay Time	N-Channel $V_{DD}=20V, R_L=20\Omega,$ $I_{DS}=1A, V_{GEN}=10V,$ $R_G=6\Omega$	N-Ch	-	7	14	ns
			P-Ch	-	5	10	
$t_r$	Turn-on Rise Time		N-Ch	-	10	19	
			P-Ch	-	11	21	
$t_{d(OFF)}$	Turn-off Delay Time	P-Channel $V_{DD}=-20V, R_L=20\Omega,$ $I_{DS}=-1A, V_{GEN}=-10V,$ $R_G=6\Omega$	N-Ch	-	17	32	
			P-Ch	-	37	68	
$t_f$	Turn-off Fall Time		N-Ch	-	3	6	
			P-Ch	-	12	23	

Note a : Pulse test ; pulse width $\leq 300\mu s$ , duty cycle $\leq 2\%$ .

Note b : Guaranteed by design, not subject to production testing.

## Typical Operating Characteristics

### N-Channel

Power Dissipation

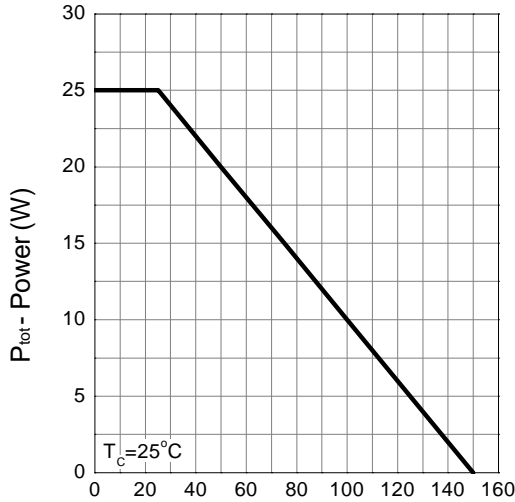

T<sub>j</sub> - Junction Temperature (°C)

Drain Current

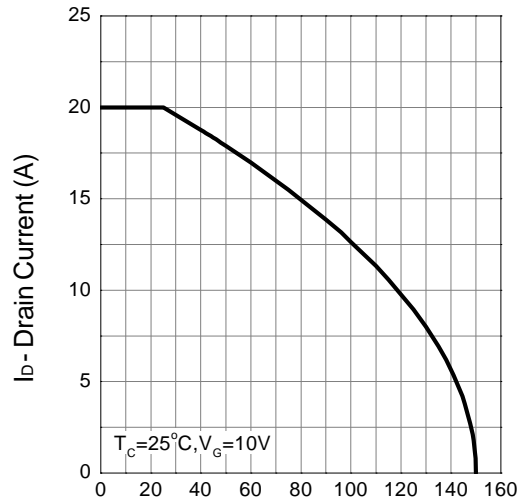

T<sub>j</sub> - Junction Temperature (°C)

Safe Operation Area

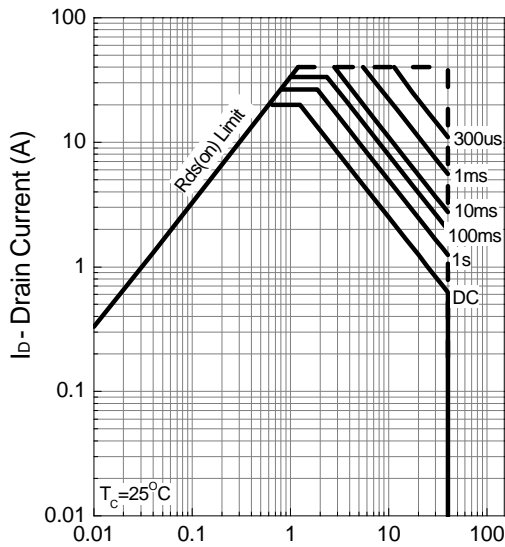

V<sub>DS</sub> - Drain - Source Voltage (V)

Thermal Transient Impedance

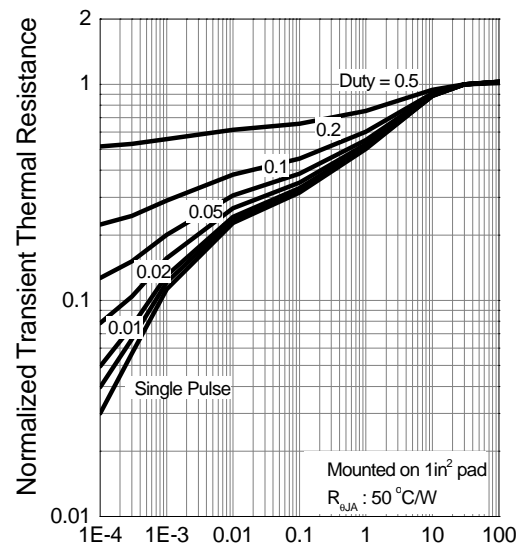

Square Wave Pulse Duration (sec)

Typical Operating Characteristics (Cont.)

N-Channel

Output Characteristics

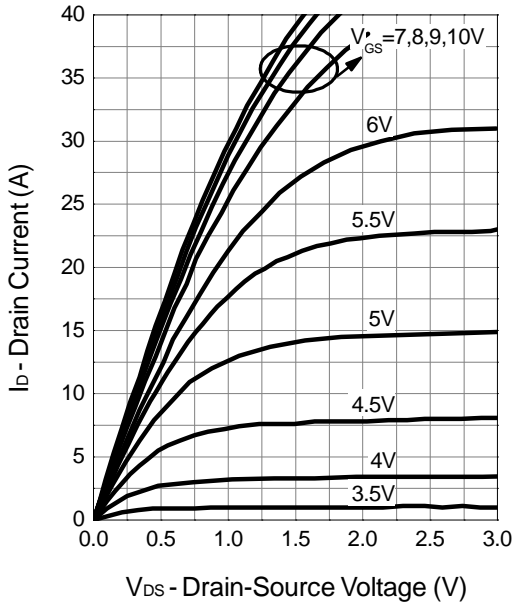

Drain-Source On Resistance

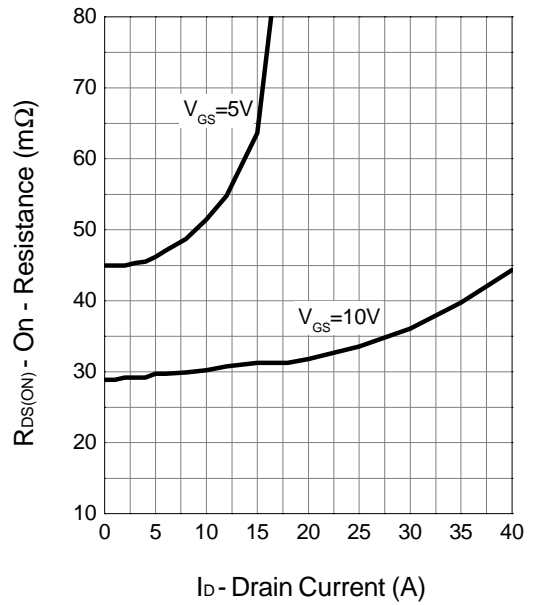

Drain-Source On Resistance

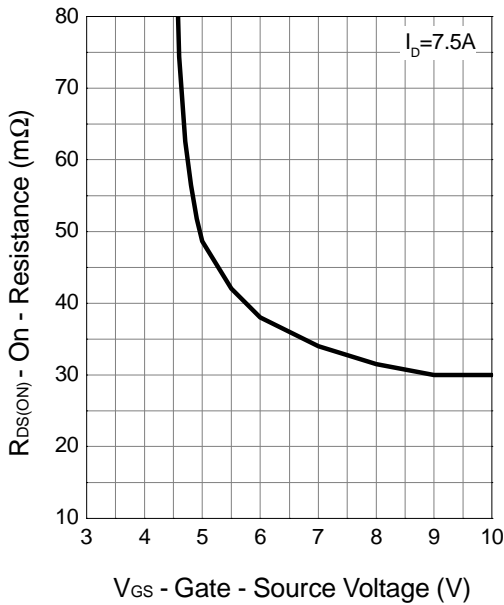

Gate Threshold Voltage

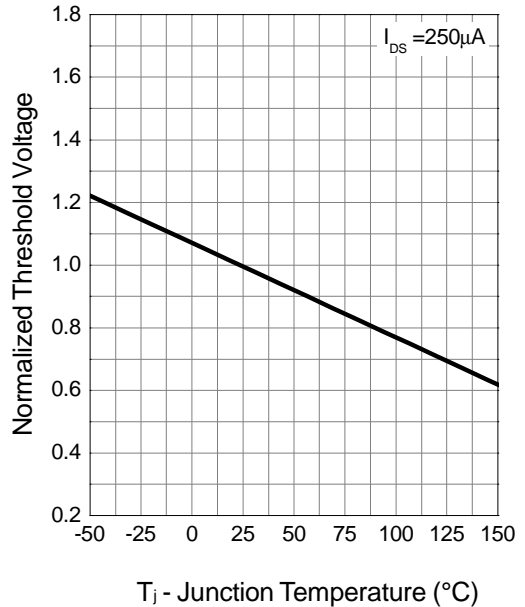

Typical Operating Characteristics (Cont.)

N-Channel

Drain-Source On Resistance

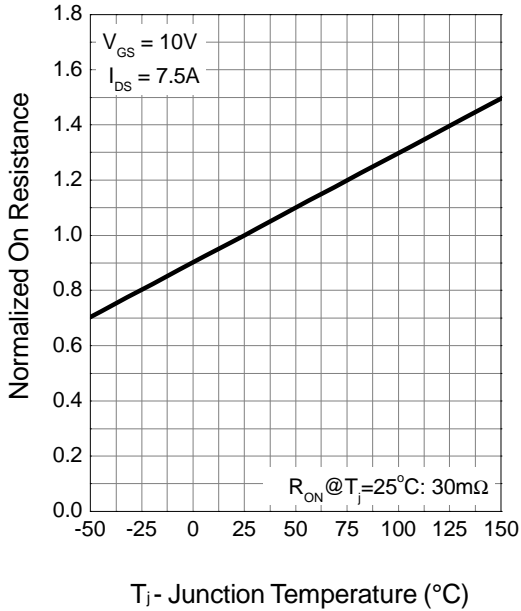

Source-Drain Diode Forward

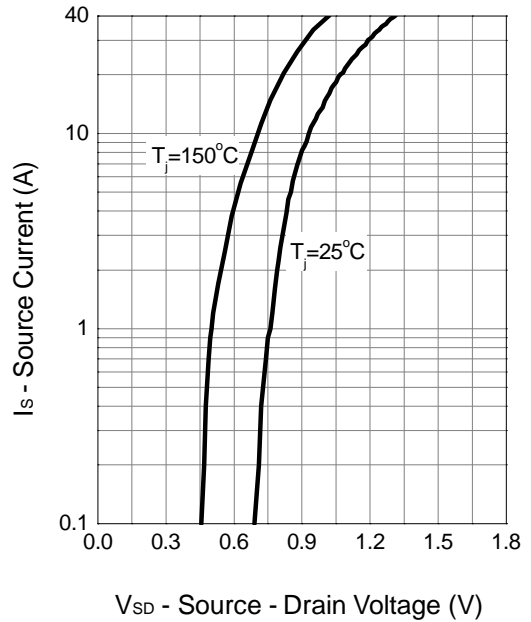

Capacitance

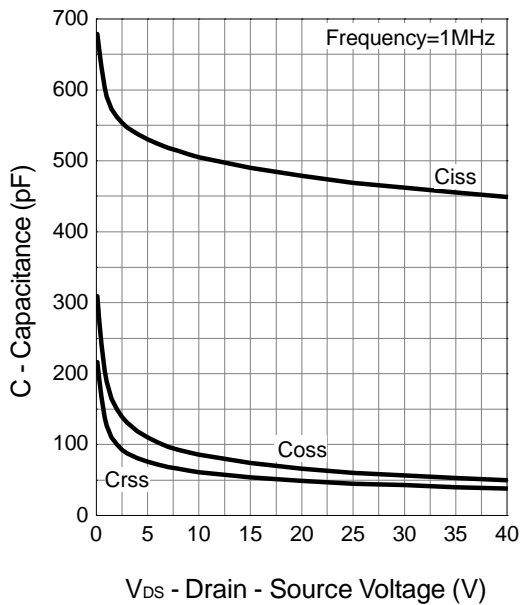

Gate Charge

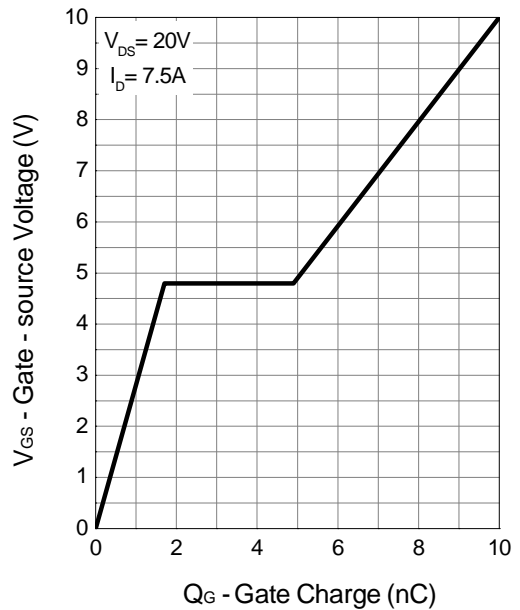

Typical Operating Characteristics (Cont.)

P-Channel

Power Dissipation

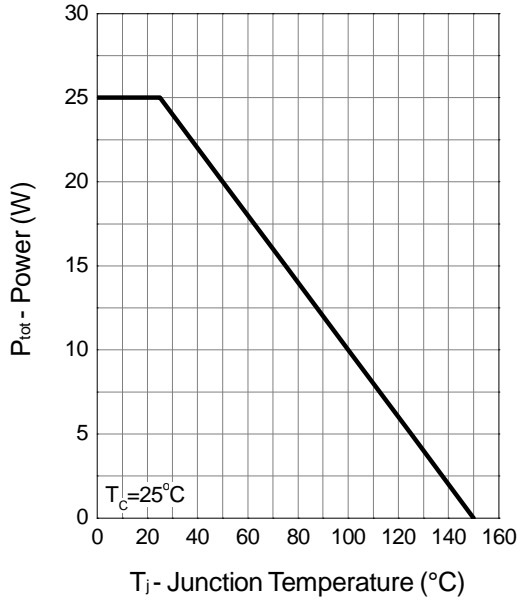

Drain Current

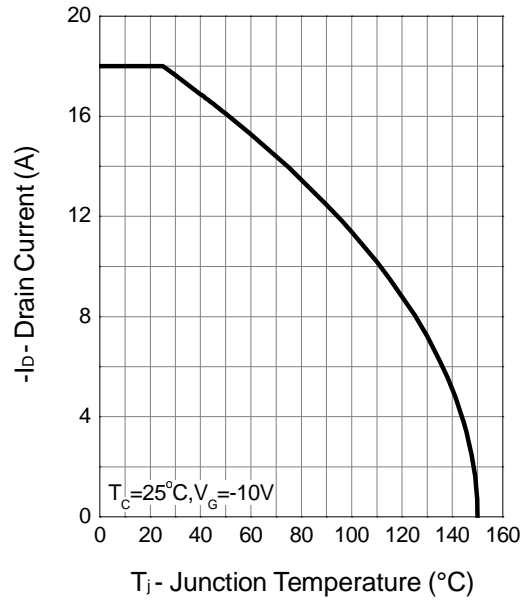

Safe Operation Area

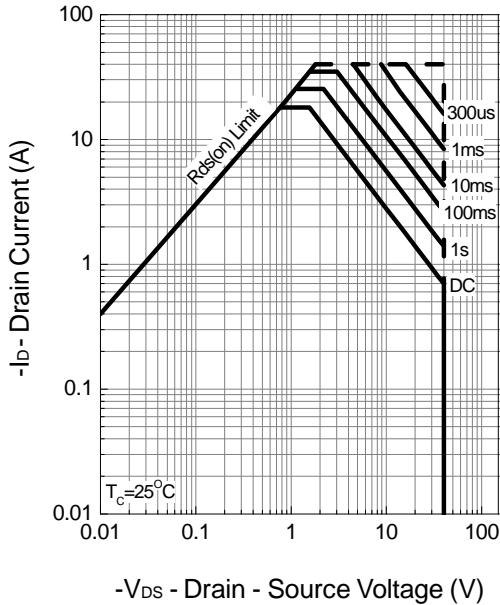

Thermal Transient Impedance

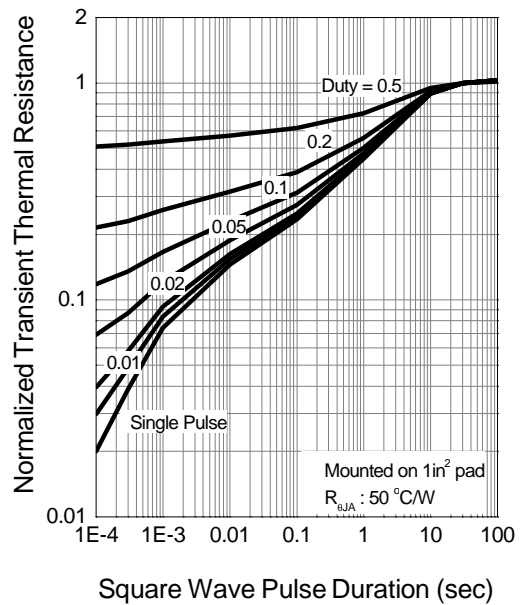

Typical Operating Characteristics (Cont.)

P-Channel

Output Characteristics

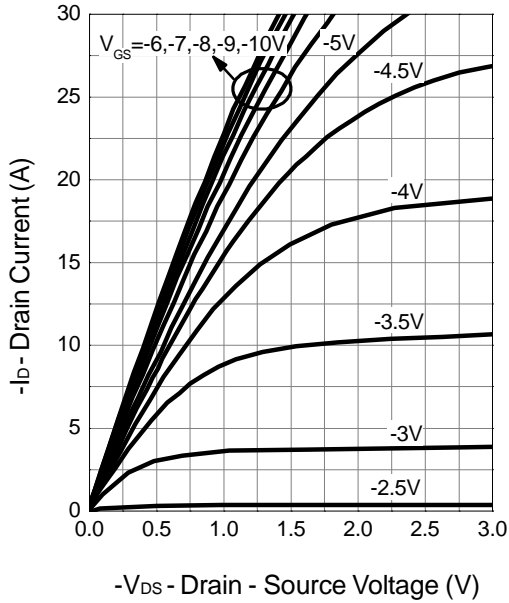

Drain-Source On Resistance

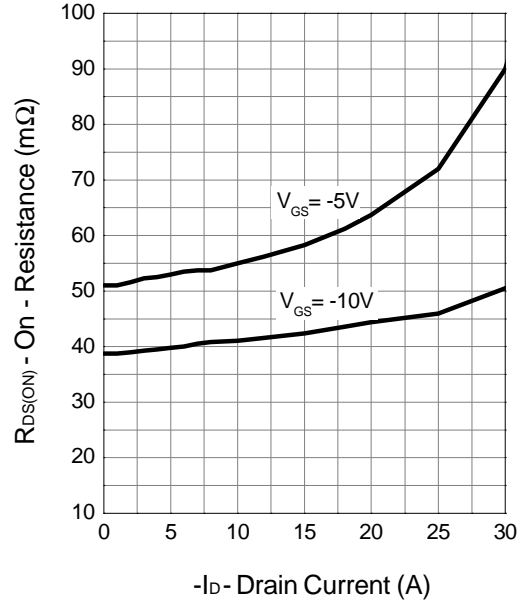

Drain-Source On Resistance

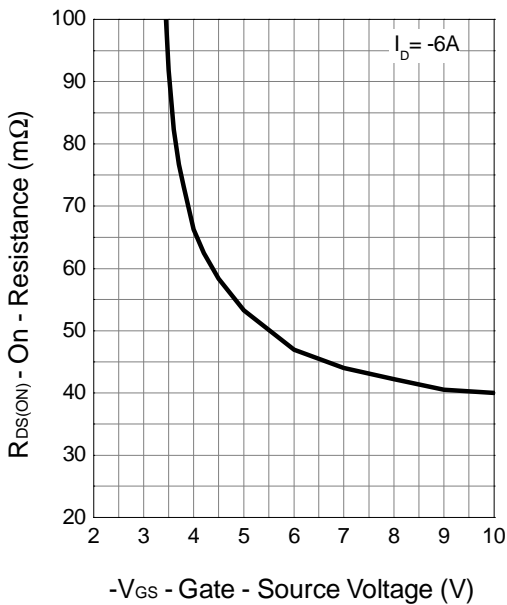

Gate Threshold Voltage

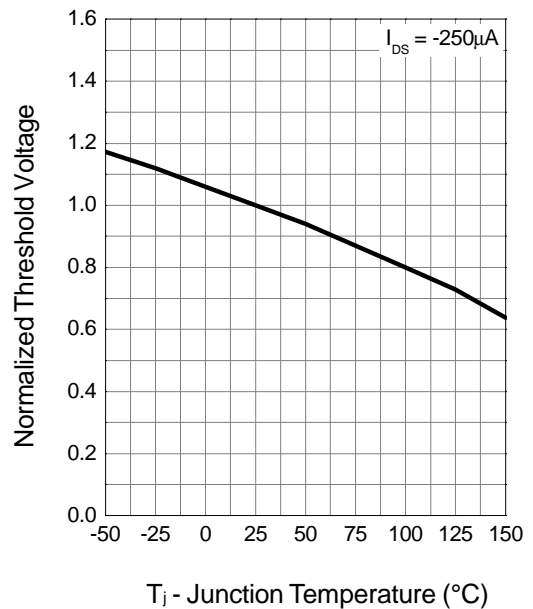



Typical Operating Characteristics (Cont.)

P-Channel

Drain-Source On Resistance

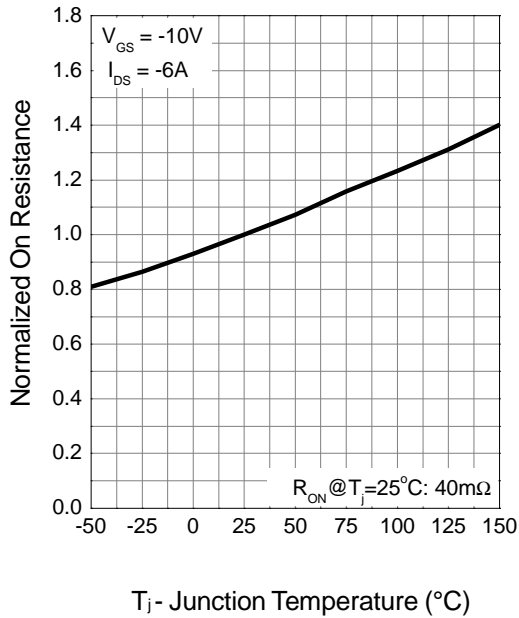

Source-Drain Diode Forward

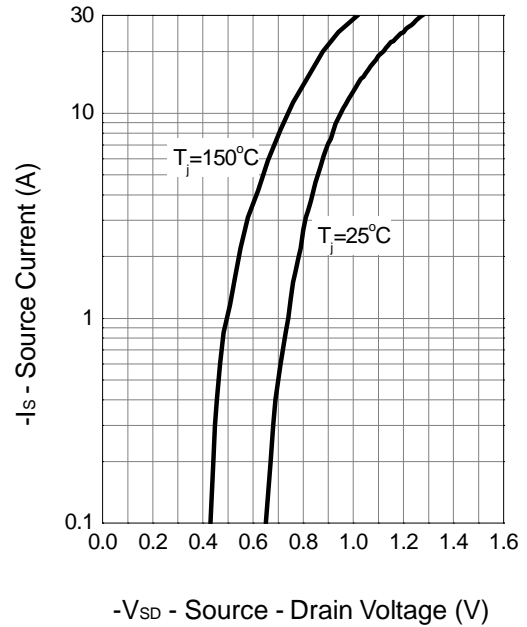

Capacitance

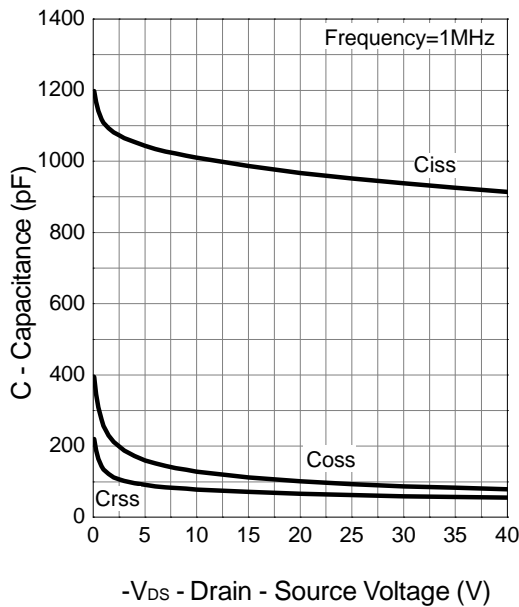

Gate Charge

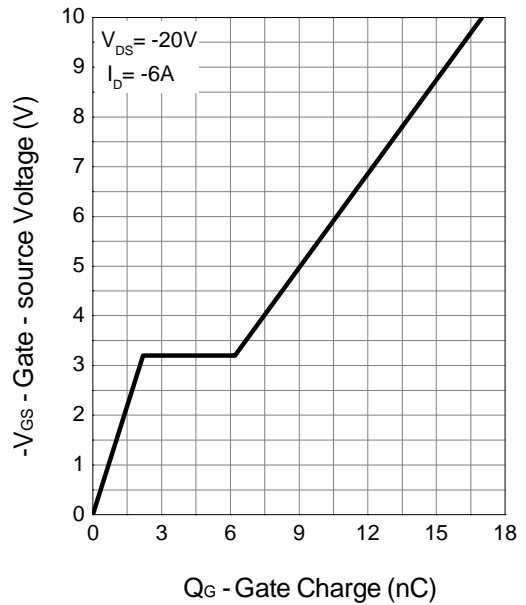

Package Information

TO-252-4

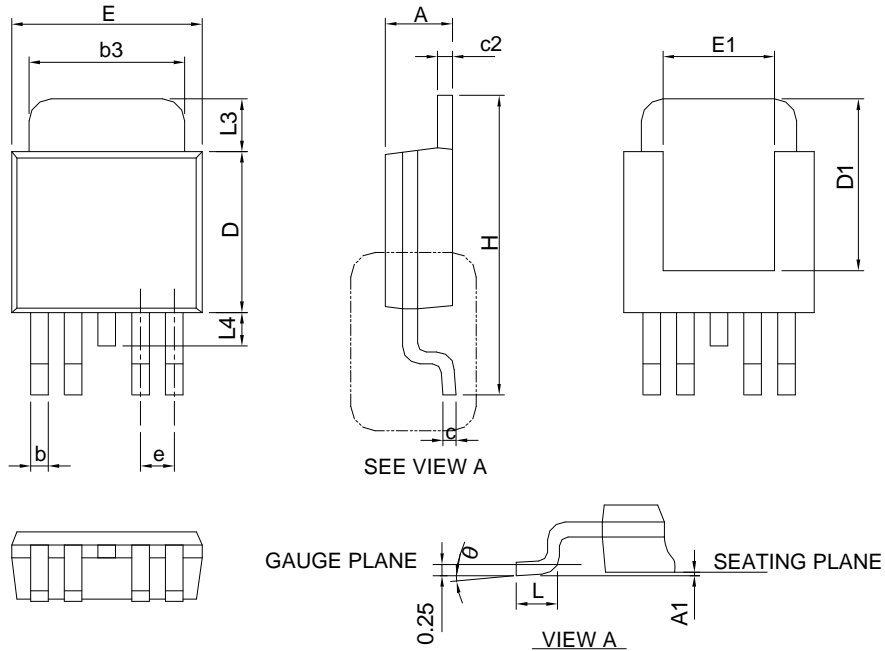

SYMBOL	TO-252-4			
	MILLIMETERS		INCHES	
	MIN.	MAX.	MIN.	MAX.
A	2.18	2.39	0.086	0.094
A1		0.13		0.005
b	0.50	0.71	0.020	0.028
b3	4.32	5.46	0.170	0.215
c	0.46	0.61	0.018	0.024
c2	0.46	0.89	0.018	0.035
D	5.33	6.22	0.210	0.245
D1	4.57	6.00	0.180	0.236
E	6.35	6.73	0.250	0.265
E1	3.81	6.00	0.150	0.236
e	1.27 BSC		0.050 BSC	
H	9.40	10.41	0.370	0.410
L	1.40	1.78	0.055	0.070
L3	0.89	2.03	0.035	0.080
L4		1.02		0.040
$\theta$	0°	8°	0°	8°

### Carrier Tape & Reel Dimensions

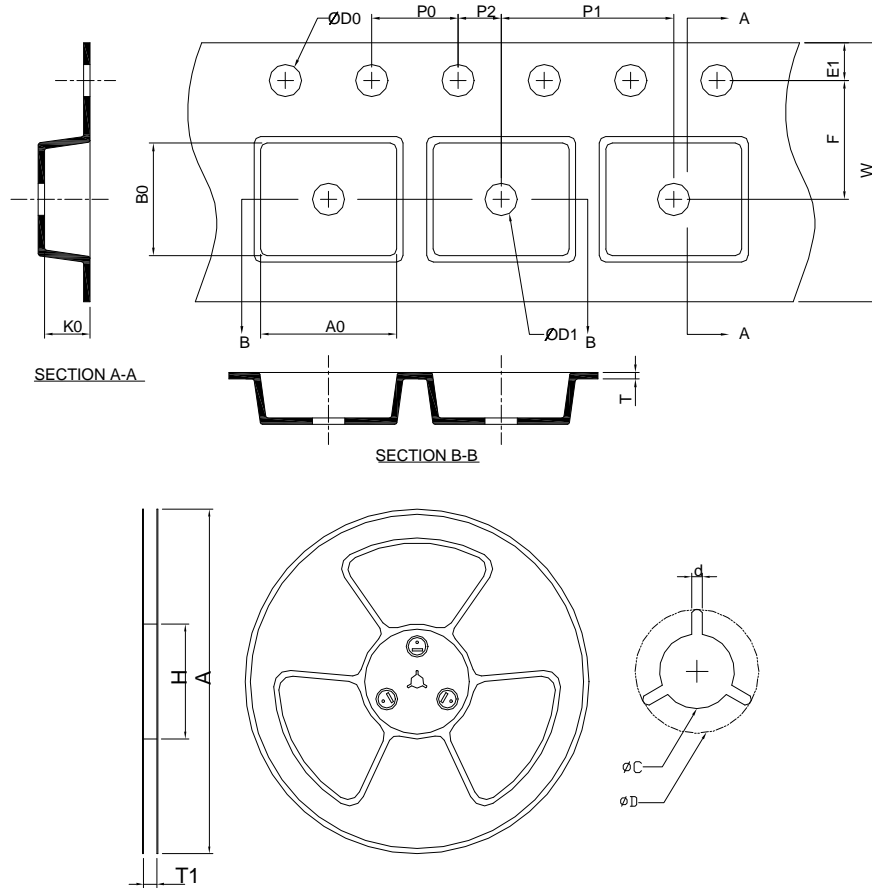

Application	A	H	T1	C	d	D	W	E1	F
TO-252-4	330.0 ±0.00	50 MIN.	16.4+2.00 -0.00	13.0+0.50 -0.20	1.5 MIN.	20.2 MIN.	16.0 ±0.30	1.75 ±0.10	7.50 ±0.05
	P0	P1	P2	D0	D1	T	A0	B0	K0
	4.0 ±0.10	8.0 ±0.10	2.0 ±0.05	1.5+0.10 -0.00	1.5 MIN.	0.6+0.00 -0.40	6.80 ±0.20	10.40 ±0.20	2.50 ±0.20

(mm)

### Devices Per Unit

Package Type	Unit	Quantity
TO-252-4	Tape & Reel	2500

## Taping Direction Information

TO-252-4

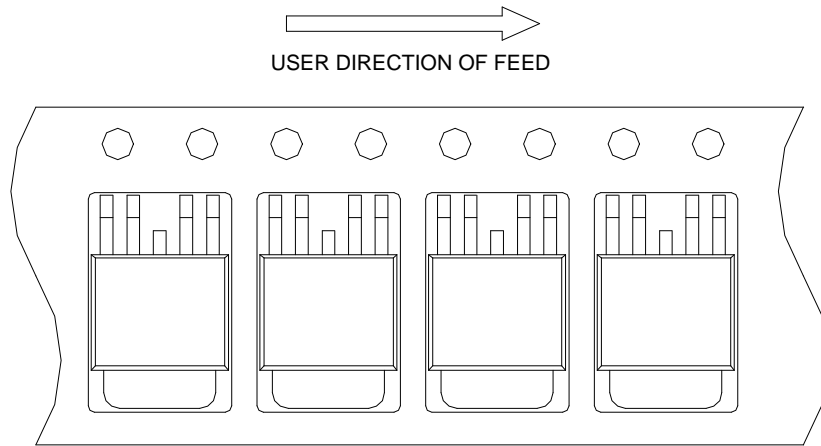

## Reflow Condition (IR/Convection or VPR Reflow)

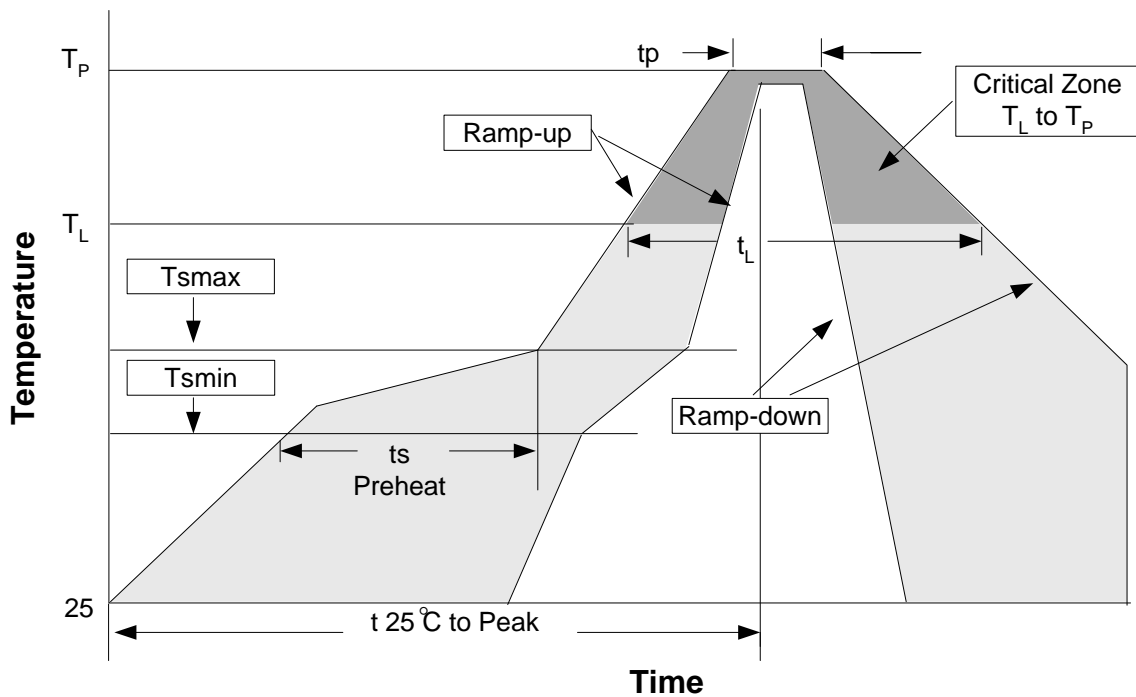

## Reliability Test Program

Test item	Method	Description
SOLDERABILITY	MIL-STD-883D-2003	245°C, 5 sec
HOLT	MIL-STD-883D-1005.7	1000 Hrs Bias @125°C
PCT	JESD-22-B, A102	168 Hrs, 100%RH, 121°C
TST	MIL-STD-883D-1011.9	-65°C~150°C, 200 Cycles

## Classification Reflow Profiles

Profile Feature	Sn-Pb Eutectic Assembly	Pb-Free Assembly
Average ramp-up rate (T <sub>L</sub> to T <sub>P</sub> )	3°C/second max.	3°C/second max.
Preheat - Temperature Min (T <sub>smin</sub> ) - Temperature Max (T <sub>smax</sub> ) - Time (min to max) (t <sub>s</sub> )	100°C 150°C 60-120 seconds	150°C 200°C 60-180 seconds
Time maintained above: - Temperature (T <sub>L</sub> ) - Time (t <sub>L</sub> )	183°C 60-150 seconds	217°C 60-150 seconds
Peak/Classification Temperature (T <sub>p</sub> )	See table 1	See table 2
Time within 5°C of actual Peak Temperature (t <sub>p</sub> )	10-30 seconds	20-40 seconds
Ramp-down Rate	6°C/second max.	6°C/second max.
Time 25°C to Peak Temperature	6 minutes max.	8 minutes max.

Note: All temperatures refer to topside of the package. Measured on the body surface.

Table 1. SnPb Eutectic Process – Package Peak Reflow Temperatures

Package Thickness	Volume mm <sup>3</sup> <350	Volume mm <sup>3</sup> ≥350
<2.5 mm	240 +0/-5°C	225 +0/-5°C
≥2.5 mm	225 +0/-5°C	225 +0/-5°C

Table 2. Pb-free Process – Package Classification Reflow Temperatures

Package Thickness	Volume mm <sup>3</sup> <350	Volume mm <sup>3</sup> 350-2000	Volume mm <sup>3</sup> >2000
<1.6 mm	260 +0°C*	260 +0°C*	260 +0°C*
1.6 mm – 2.5 mm	260 +0°C*	250 +0°C*	245 +0°C*
≥2.5 mm	250 +0°C*	245 +0°C*	245 +0°C*

\*Tolerance: The device manufacturer/supplier **shall** assure process compatibility up to and including the stated classification temperature (this means Peak reflow temperature +0°C. For example 260°C+0°C) at the rated MSL level.

## Customer Service

### Anpec Electronics Corp.

Head Office :

No.6, Dusing 1st Road, SBIP,

Hsin-Chu, Taiwan, R.O.C.

Tel : 886-3-5642000

Fax : 886-3-5642050

Taipei Branch :

2F, No. 11, Lane 218, Sec 2 Jhongsing Rd.,

Sindain City, Taipei County 23146, Taiwan

Tel : 886-2-2910-3838

Fax : 886-2-2917-3838