

KPB-3025SRPGC-PRV

SUPER BRIGHT RED  
PURE GREEN

### Features

- 3.0mmx2.5mm SMT LED, 1.1mm THICKNESS.
- BI -COLOR, LOW POWER CONSUMPTION.
- WIDE VIEWING ANGLE.
- IDEAL FOR BACKLIGHT AND INDICATOR.
- VARIOUS COLORS AND LENS TYPES AVAILABLE.
- PACKAGE : 2000PCS / REEL.

### Description

The Super Bright Red source color devices are made with Gallium Aluminum Arsenide Red Light Emitting Diode.

The Pure Green source color devices are made with Gallium Phosphide Pure Green Light Emitting Diode.

### Package Dimensions

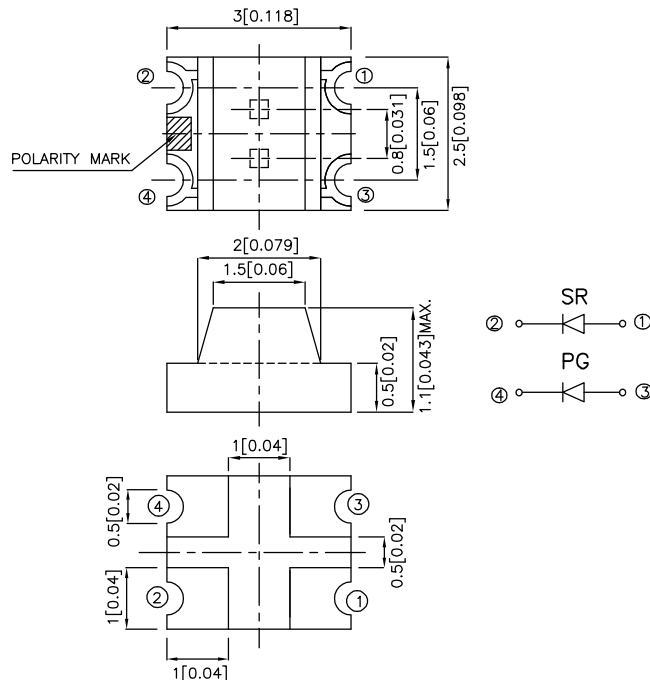

#### Notes:

1. All dimensions are in millimeters (inches).
2. Tolerance is  $\pm 0.2$  (0.008") unless otherwise noted.
3. Specifications are subject to change without notice.

## Selection Guide

Part No.	Dice	Lens Type	Iv (mcd) @ 20mA		Viewing Angle
			Min.	Typ.	2 θ 1/2
KPB-3025SRPGC-PRV	SUPER BRIGHT RED (GaAlAs)	WATER CLEAR	36	100	120°
	PURE GREEN (GaP)		1.6	5	

Note:

1. θ1/2 is the angle from optical centerline where the luminous intensity is 1/2 the optical centerline value.

## Electrical / Optical Characteristics at TA=25°C

Symbol	Parameter	Device	Typ.	Max.	Units	Test Conditions
$\lambda_{peak}$	Peak Wavelength	Super Bright Red Pure Green	660 555		nm	IF=20mA
$\lambda_D$	Dominant Wavelength	Super Bright Red Pure Green	640 555		nm	IF=20mA
$\Delta\lambda_{1/2}$	Spectral Line Half-width	Super Bright Red Pure Green	20 30		nm	IF=20mA
C	Capacitance	Super Bright Red Pure Green	45 45		pF	VF=0V;f=1MHz
VF	Forward Voltage	Super Bright Red Pure Green	1.85 2.25	2.5 2.5	V	IF=20mA
IR	Reverse Current	All		10	uA	VR = 5V

## Absolute Maximum Ratings at TA=25°C

Parameter	Super Bright Red	Pure Green	Units
Power dissipation	100	105	mW
DC Forward Current	30	25	mA
Peak Forward Current [1]	155	135	mA
Reverse Voltage	5		V
Operating/Storage Temperature	-40°C To +85°C		

Notes:

1. 1/10 Duty Cycle, 0.1ms Pulse Width.

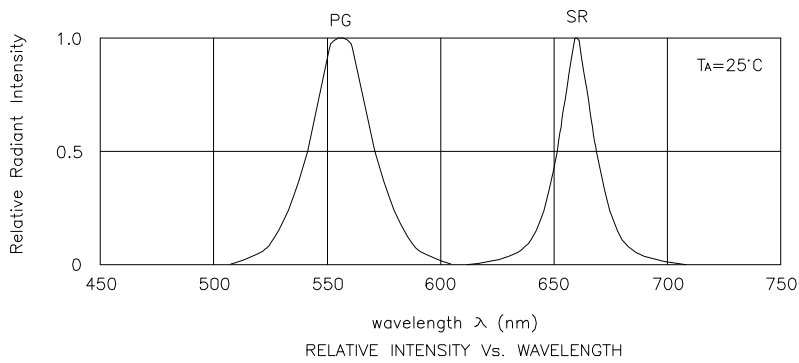

## KPB-3025SRPGC-PRV Super Bright Red

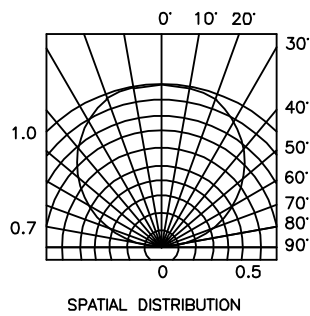
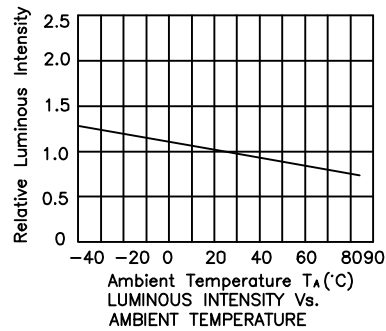
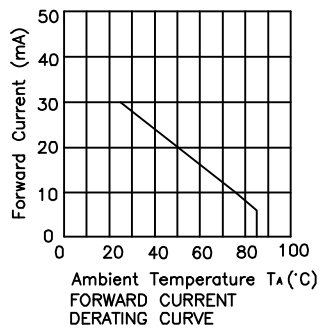
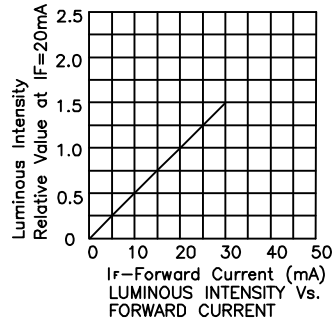
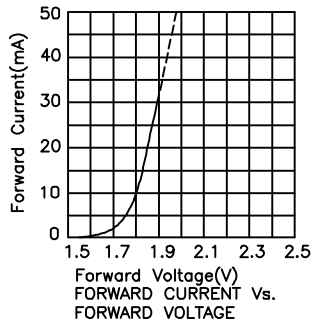

# Kingbright

## Pure Green

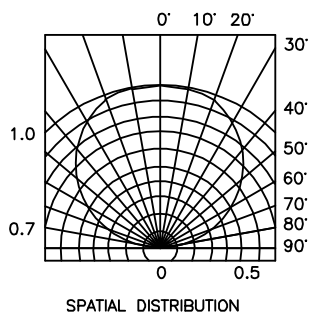
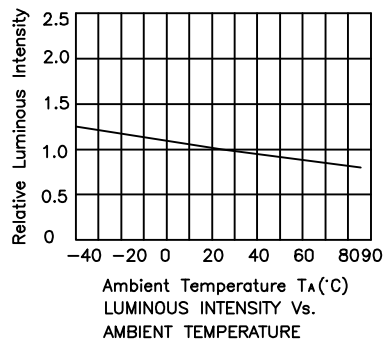
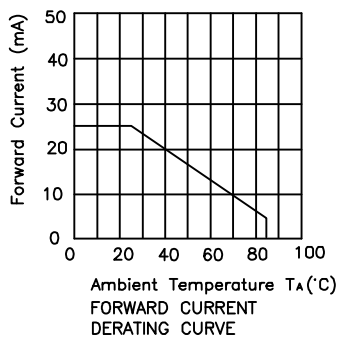
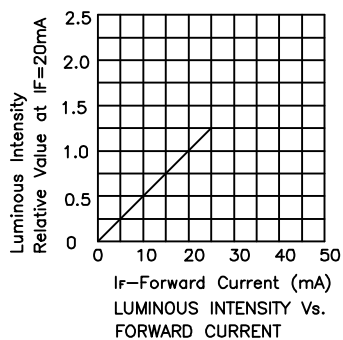
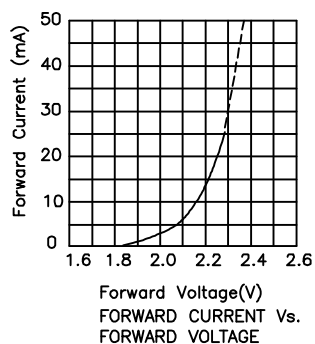

## KPB-3025SRPGC-PRV

### SMT Reflow Soldering Instructions

Number of reflow process shall be 2 times or less and cooling process to normal temperature is required between first and second soldering process.

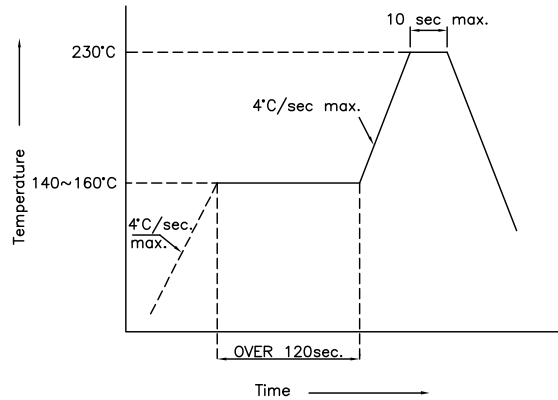

### Recommended Soldering Pattern (Units : mm)

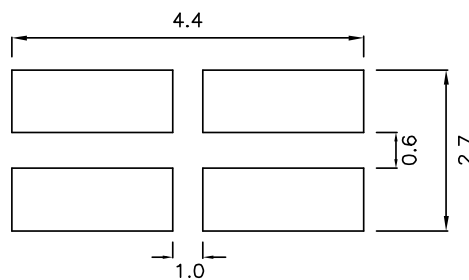

### Tape Specifications (Units : mm)

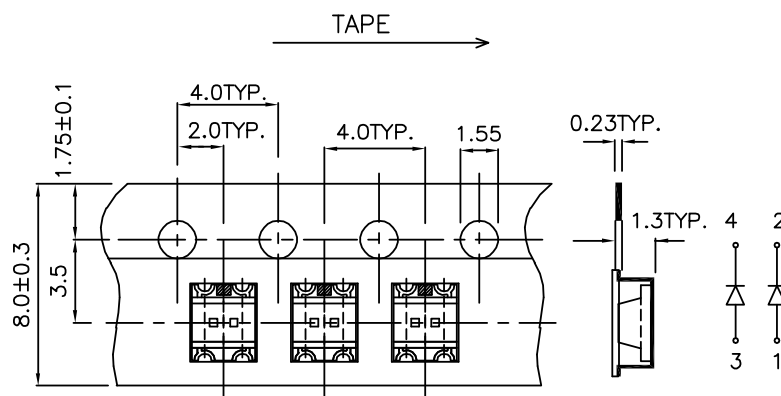

#### Remarks:

If special sorting is required (e.g. binning based on forward voltage, luminous intensity, or wavelength), the typical accuracy of the sorting process is as follows:

1. Wavelength: +/-1nm
2. Luminous Intensity: +/-15%
3. Forward Voltage: +/-0.1V

Note: Accuracy may depend on the sorting parameters.