

**Interference Suppression
Film capacitors**

**PCX2 337x6
(Mini)**

MKP RADIAL POTTED CAPACITORS

Pitch 10.0/15.0/22.5/27.5mm

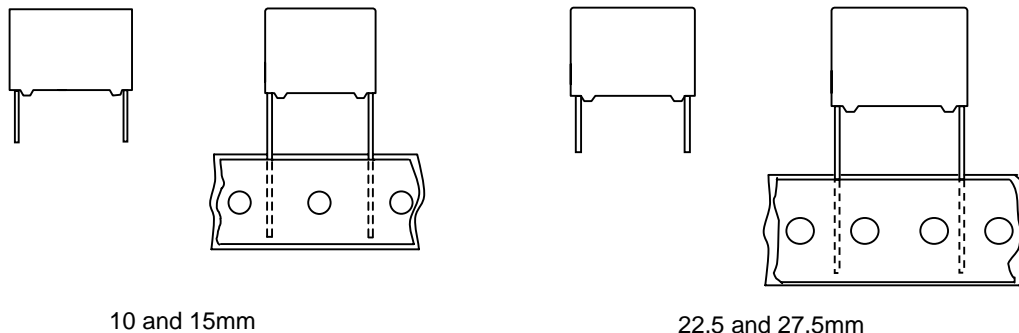

QUICK REFERENCE DATA

Capacitance range (E6 series) *	0.01 μ F to 3.3 μ F
Capacitance tolerance	$\pm 10 \%$, $\pm 20 \%$
Rated (AC) voltage 50 to 60 Hz	275 V \sim
Climatic category	40/105/21
Temperature range	-40 ~ +105
Reference IEC specification	IEC 60384-14(3rd edition) and EN 60384-14
Safety approvals	UL1414 & CSA-C 22.2 NO. 1, ENEC, CQC UL1283 & CSA-C 22.2 NO. 8
Potting & Encapsulation material	Qualified in accordance with UL 94V-0
Safety class	X2

* Intermediate values of the E12 series are available to special order

<p>FEATURES</p> <ul style="list-style-type: none"> . 10.0 to 27.5 mm lead pitch . Supplied loose in box and taped on reel . Consist of a low-inductive wound cell of Metallized Polypropylene film, potted in a flame retardant case 	<p>APPLICATIONS</p> <ul style="list-style-type: none"> . For X2-electromagnetic interference suppression . Specially designed to meet the NEW REQUIREMENTS in new IEC 60384-14 specification(3rd edition)/EN 60384-14 requiring for X2 a 2.5kV peak pulse voltage test and the UL1414 and CSA-C22.2 No 1 specification
--	--

• Please refer to caution and warning at <http://www.pilkor.co.kr/download/Introductions.pdf> before using these products.

Ordering Information

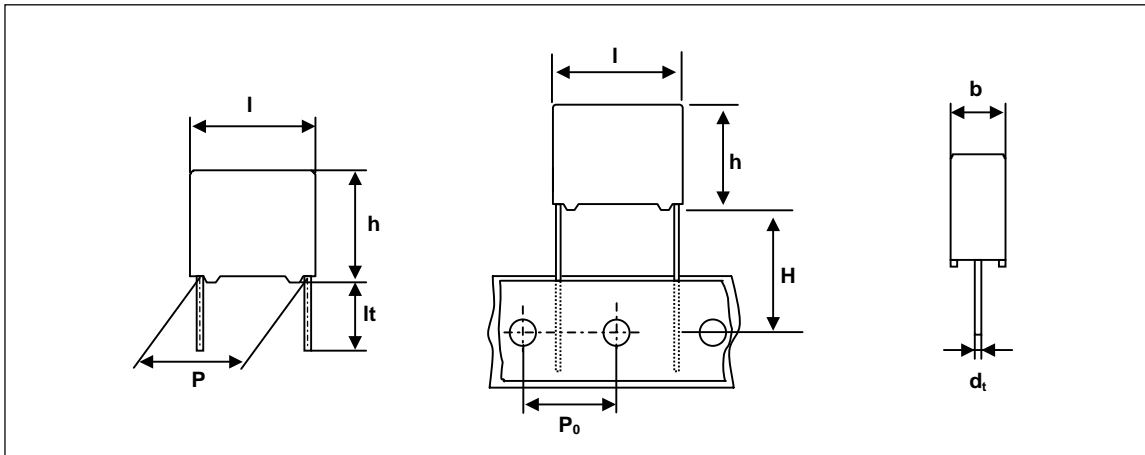

PCX2 337 X X X XXX

Capacitance

Code	Voltage
6	275V

Code	Original Pitch
D	10.0 mm
F	15.0 mm
J	22.5 mm
L	27.5 mm

Available versions					Product (I _{max})			
code	Packing method	C - tol.	Lead length & Height	Hole to hole (P ₀)	12.5	18.0	26.0	31.0
					Pitch (P)			
0	Loose in box	± 20%	lt = 5.0 ± 1.0mm	-	10.0	15.0	22.5	27.5
1	Loose in box	± 10%	lt = 5.0 ± 1.0mm	-	10.0	15.0	22.5	27.5
4	Loose in box	± 20%	lt = 25.0 ± 2.0mm	-	10.0	15.0	22.5	27.5
5	Loose in box	± 10%	lt = 25.0 ± 2.0mm	-	10.0	15.0	22.5	27.5
6	Ammopack	± 20%	H = 18.5mm	12.7mm	10.0	15.0	22.5	27.5
7	Ammopack	± 10%	H = 18.5mm	12.7mm	10.0	15.0	22.5	27.5

Interference Suppression Film capacitors

**PCX2 337x6
(Mini)**

SAFETY APPROVALS

SAFETY APPROVALS	Voltage	Value	File Number
UL1414 & CSA C22.2 NO 1	250V(AC)	10nF to 1.0 μ F	E165646
UL1283 & CSA C22.2 No.8	275V(AC)	C > 1 μ F	E208404
ENEC(SEMKO) *	275V(AC)	10nF to 3.3 μ F	SE/0256-1
EK	275V(AC)	10nF to 3.3 μ F	SH03001-2003
CQC	275V(AC)	10nF to 3.3 μ F	CQC04001009332

* The ENEC-approval together with the CB-Certificate replace all national approval marks of the following countries(they have already signed the ENEC-Agreement): Austria; Belgium; Czech. Republic; Denmark; Finland; France; Germany; Greece; Hungary; Ireland; Italy; Luxembourg; Netherlands; Norway; Portugal; Slovenian; Spain; Sweden; Switzerland and United Kingdom

Packaging Information

SMALLEST PACKING QUANTITIES (SPQ)	LOOSE IN BOX	
	It = 5.0 \pm 1.0 mm	It = 25 \pm 2.0 mm
DIMENSIONS		
4.0 x 10.0 x 12.5	2000	1200
5.0 x 11.0 x 12.5	1500	1000
6.0 x 12.0 x 12.5	1000	1000
5.0 x 11.0 x 18.0	1000	1000
6.0 x 12.0 x 18.0	1000	1000
7.0 x 13.5 x 18.0	1000	1000
8.5 x 15.0 x 18.0	1000	1000
10.0 x 16.5 x 18.0	1000	1000
11.0 x 18.5 x 18.0	1000	1000
6.0 x 15.5 x 26.0	1000	1000
7.0 x 16.5 x 26.0	1000	1000
8.5 x 18.0 x 26.0	500	500
10.0 x 19.5 x 26.0	500	500
11.5 x 21.0 x 26.0	500	500
13.0 x 23.0 x 26.0	500	500
9.0 x 18.0 x 31.0	500	500
11.0 x 21.0 x 31.0	500	250
13.0 x 23.0 x 31.0	250	250
15.0 x 25.0 x 31.0	250	250
18.0 x 28.0 x 31.0	200	200

Interference Suppression Film capacitors

PCX2 337x6 (Mini)

SPECIFIC REFERENCE DATA FOR 275 V_{AC}

Tangent of loss angle	at 1 khz	at 10 khz
C 470 nF 470 nF < C 1 μF C > 1 μF	10×10^{-4} 20×10^{-4} 30×10^{-4}	20×10^{-4} 70×10^{-4} -
Rated voltage pulse slope (dV/dt) _R	100 V/μs	
R between leads, for C 0.33 μF	15 000 MΩ	
RC between leads, for C > 0.33 μF	5 000 s	
Withstanding(DC) Voltage (cut-off current 10mA)		
C 1 μF C > 1 μF	2250 V 1min 1850 V 1min	

V_{Rac} = 275 V X2

Cap. (μF)	b x h x l (mm)	MASS (g)	CATALOGUE NUMBER			
			PCX2 337			
			loose in box			
			lt = 5 ± 1.0 mm		lt = 25 ± 2.0 mm	
			C - tol. ±20 %	C - tol. ±10 %	C - tol. ±20 %	C - tol. ±10 %
Pitch = 10.0 ± 0.4 mm			dt = 0.6 +0.06/-0.05 mm			
0.01	4.0x 10.0x 12.5	0.8	D60103	D61103	D64103	D65103
0.015	4.0x 10.0x 12.5	0.8	D60153	D61153	D64153	D65153
0.022	4.0x 10.0x 12.5	0.8	D60223	D61223	D64223	D65223
0.033	5.0x 11.0 x 12.5	0.9	D60333	D61333	D64333	D65333
0.047	5.0x 11.0 x 12.5	0.9	D60473	D61473	D64473	D65473
0.068	6.0 x 12.0 x 12.5	1.0	D60683	D61683	D64683	D65683
0.1	6.0 x 12.0 x 12.5	1.0	D60104	D61104	D64104	D65104

Interference Suppression Film capacitors

PCX2 337x6 (Mini)

 $V_{Rac} = 275 V \cdot X2$

loose and taped

Cap. (μF)	b x h x l (mm)	MASS (g)	CATALOGUE NUMBER			
			PCX2 337			
			loose in box			
			lt = 5 \pm 1.0 mm		lt = 25 \pm 2.0 mm	
			C - tol. ± 20 %	C - tol. ± 10 %	C - tol. ± 20 %	C - tol. ± 10 %
Pitch = 15.0 \pm 0.4 mm			dt = 0.6 +0.06/-0.05 mm			
0.01	5.0 x 11.0 x 18.0	1.6	F60103	F61103	F64103	F65103
0.015	5.0 x 11.0 x 18.0	1.6	F60153	F61153	F64153	F65153
0.022	5.0 x 11.0 x 18.0	1.6	F60223	F61223	F64223	F65223
0.033	5.0 x 11.0 x 18.0	1.6	F60333	F61333	F64333	F65333
0.047	5.0 x 11.0 x 18.0	1.6	F60473	F61473	F64473	F65473
0.068	5.0 x 11.0 x 18.0	1.6	F60683	F61683	F64683	F65683
0.1	5.0 x 11.0 x 18.0	1.6	F60104	F61104	F64104	F65104
0.15	6.0 x 12.0 x 18.0	1.7	F60154	F61154	F64154	F65154
Pitch = 15.0 \pm 0.4 mm			dt = 0.8 +0.08/-0.05 mm			
0.22	7.0 x 13.5 x 18.0	1.9	F60224	F61224	F64224	F65224
0.33	8.5 x 15.0 x 18.0	2.6	F60334	F61334	F64334	F65334
0.47	10.0 x 16.5 x 18.0	3.1	F60474	F61474	F64474	F65474
0.68	11.0 x 18.5 x 18.0	4.1	F60684	F61684	F64684	F65684
Pitch = 22.5 \pm 0.4 mm			dt = 0.8 +0.08/-0.05 mm			
0.22	6.0 x 15.5 x 26.0	3.0	J60224	J61224	J64224	J65224
0.33	6.0 x 15.5 x 26.0	3.0	J60334	J61334	J64334	J65334
0.47	7.0 x 16.5 x 26.0	3.5	J60474	J61474	J64474	J65474
0.68	8.5 x 18.0 x 26.0	4.4	J60684	J61684	J64684	J65684
1.0	10.0 x 19.5 x 26.0	5.5	J60105	-	J64105	-
1.0	11.5 x 21.0 x 26.0	6.5	-	J61105	-	J65105
1.5	13.0 x 23.0 x 26.0	8.0	J60155	J61155	J64155	J65155
Pitch = 27.5 \pm 0.4 mm			dt = 0.8 +0.08/-0.05 mm			
0.68	9.0 x 19.0 x 31.0	5.5	L60684	L61684	L64684	L65684
1.0	11.0 x 21.0 x 31.0	7.8	L60105	L61105	L64105	L65105
1.5	13.0 x 23.0 x 31.0	10.4	L60155	L61155	L64155	L65155
2.2	15.0 x 25.0 x 31.0	12.8	L60225	L61225	L64225	L65225
3.3	18.0 x 28.0 x 31.0	17.2	L60335	L61335	L64335	L65335

CONSTRUCTION

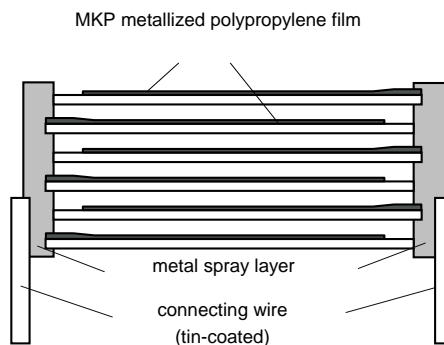

MOUNTING

NORMAL USE

The capacitors are designed for mounting on printed-circuit boards.

The capacitors packed in bandoliers are designed for mounting on printed-circuit boards by means of automatic insertion machines.

For detailed specifications refer to chapter "PACKAGING".

SPECIFIC METHOD OF MOUNTING TO WITHSTAND VIBRATION AND SHOCK

In order to withstand vibration and shock tests, it must be ensured that the stand-off pips are in good contact with the printed-circuit board.

- . For pitches of 15mm the capacitors shall be mechanically fixed by leads.
- . For larger pitches the capacitors shall be mounted in the same way and the body clamped.

SPACE REQUIREMENTS ON PRINTED-CIRCUIT BOARD

The maximum length and width of film capacitors are shown in the following drawing ;

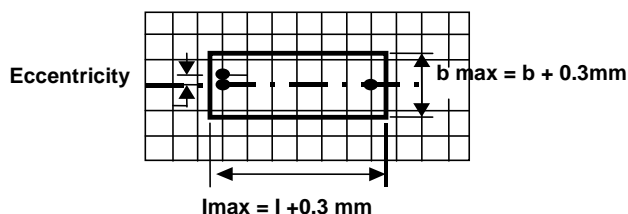

- Eccentricity as in drawing.

The maximum eccentricity is smaller than or equal to the lead diameter of the product concerned.

- Product height with seating plane as given by IEC 60717 as reference : $h_{max} \quad h + 0.3 \text{ mm}$

RATINGS AND CHARACTERISTICS

Unless otherwise specified all electrical values apply to an ambient temperature of 23 ± 1 °C, an atmospheric pressure of 86 to 106kPa and a relative humidity $50 \pm 2\%$.

For reference testing, a conditioning period shall be applied of 96 ± 4 hours by heating the products in a circulating air oven at the rated temperature and a relative humidity not exceeding 20%.

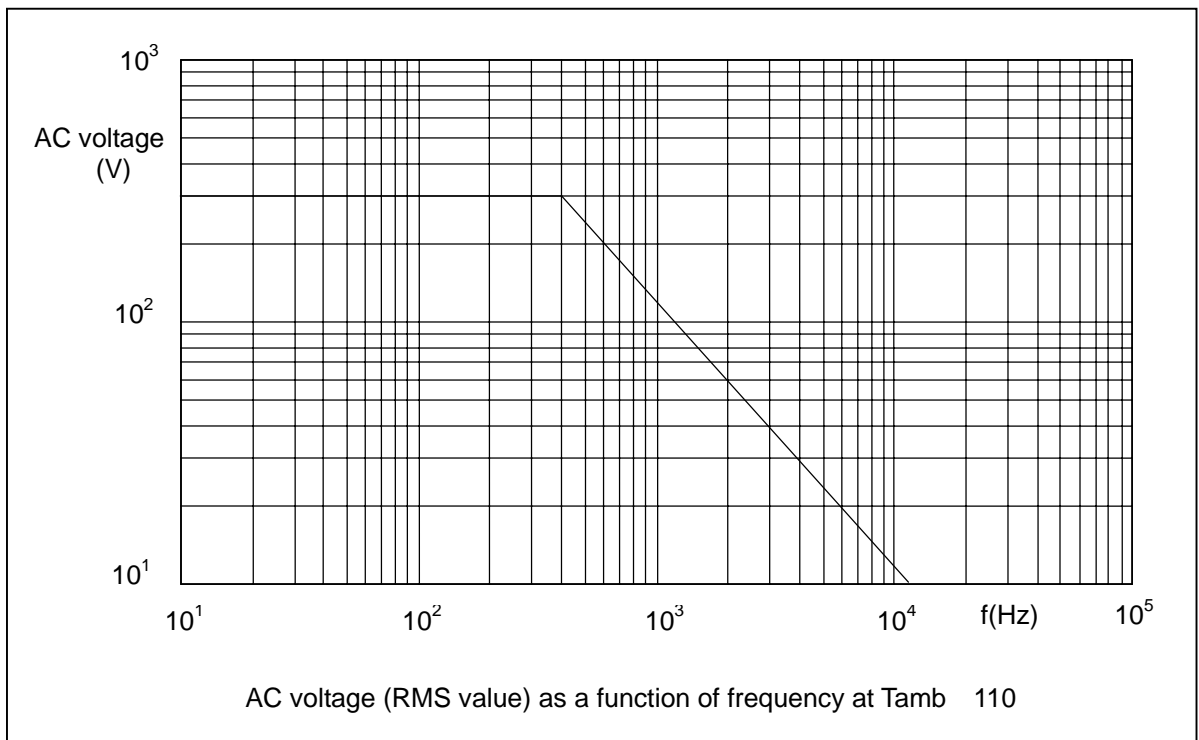
Maximum RMS Voltage as a function of frequency

Interference Suppression Film capacitors

**PCX2 337x6
(Mini)**

PRODUCT MARKING

Capacitors are marked with having following information;

- 1.Manufacturer (PILKOR)
- 2.Manufacturer's type designation (PCX2 337)
- 3.Rated capacitance in code according to IEC 60062
- 4.Rated (AC) voltage (275V~)
- 5.Sub class (X2)
- 6.Tolerance on rated capacitance M = ± 20 % K = ± 10 %
- 7.Climatic category (40/105/21)
- 8.Code for dielectric material (MKP)
- 9.Year and week of manufacturing (e.g. 0901)
- 10.Safety approvals

Example of marking

Pitch P = 10mm



Marking on the side

Pitch P = 15.0mm or P = 22.5 mm or P = 27.5mm

(C ≤ 1µF)

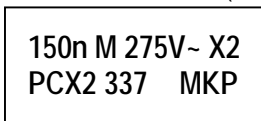

Marking on the top

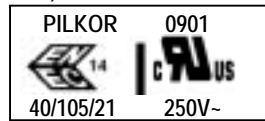

Marking on the side

or

(C > 1µF)

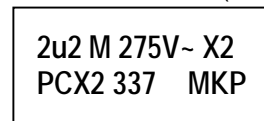

Marking on the top

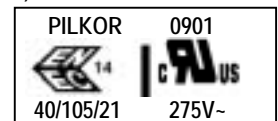

Marking on the side

Pitch P = 22.5 mm or P = 27.5mm

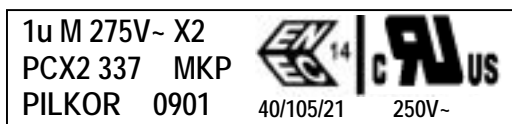

Marking on headface(C ≤ 1µF)

or

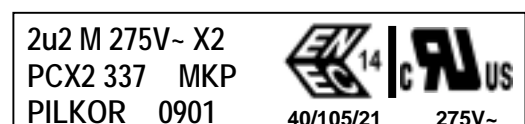

Marking on headface(C > 1µF)